

# SANMOTION

5-PHASE STEPPING SYSTEMS

# F5



**SANYO DENKI**

Ver. **6.4**

# SANMOTION

5-PHASE STEPPING SYSTEMS

# F5



AC Input Set Models Microstep

---



AC Input Drivers

---



DC Input Set Models Microstep, Full/half step

---



DC Input Drivers

---



Stepping Motors Stepping Motors, Linear Actuator Stepping Motors,  
Stepping Motors for Vacuum Environments

---



## Index

Lineup ..... p. 5

### Set Models

Features ..... p. 10

#### AC Input Set Models/Drivers

Microstep ..... p. 12

System Configuration Diagram ..... p. 12

Set Model Numbering Convention ..... p. 13

Set Model Configuration ..... p. 14

Specifications 100 V series ..... p. 17

Specifications 200 V series ..... p. 28

Stepping Motor: Dimensions ..... p. 39

Stepping Motor: General Specifications ..... p. 44

Driver Dimensions ..... p. 45

Driver Specifications ..... p. 45

#### DC Input Set Models/Drivers

Microstep ..... p. 52

System Configuration Diagram ..... p. 52

Set Model Numbering Convention ..... p. 53

Set Model Configuration ..... p. 54

Specifications ..... p. 56

Stepping Motor: Dimensions ..... p. 71

Stepping Motor: General Specifications ..... p. 75

Driver Dimensions ..... p. 76

Driver Specifications ..... p. 77

#### DC Input Set Models/Drivers

Full/half step ..... p. 82

System Configuration Diagram ..... p. 82

Set Model Numbering Convention ..... p. 83

Set Model Configuration ..... p. 84

Specifications ..... p. 85

(Stepping Motor Dimensions, General Specifications,  
Internal Wiring, and Rotation Directions → p. 71–)

Driver Dimensions ..... p. 100

Driver Specifications ..... p. 100

### Stepping Motors

Lineup ..... p. 106

Stepping Motors ..... p. 108

Linear Actuator Stepping Motors ..... p. 115

Stepping Motors for Vacuum Environments ..... p. 117

Safety Precautions ..... p. 118

Index by Model No. .... p. 121

The SANMOTION F5 is a 5-phase stepping system that provides precise positioning with easy control. The typical basic step angle is  $0.72^\circ$ , and accurate control is provided by pulse signals.

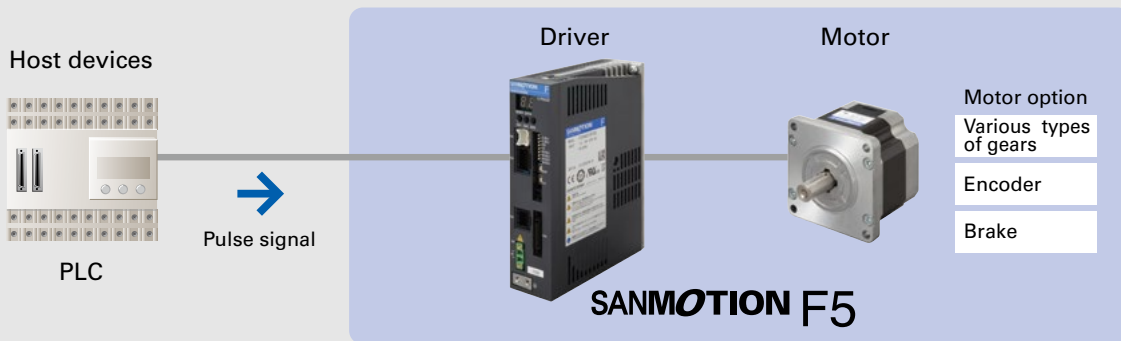

• **What is a stepping motor?**

A stepping motor is a motor that rotates at a fixed angle for each pulse. The rotation speed is proportional to the speed of the command pulse (frequency). Also, the rotation angle can be controlled according to the number of command pulses. Stepping motors are able to make stable stops without vibrating, as they have holding power when the motor is stopped.

## Application Examples

The SANMOTION F5 can be used in a wide variety of applications, including fixed-speed drive synchronized to a command pulse, accurate positioning, and stable stopping.

- Semiconductor devices, analytical and testing devices used in medical and environmental fields, ATMs, monitoring cameras and spotlights, packaging machines, embroidering machines, automatic ticket gates and more



ATMs



Blood analyzers



Wafer cleaners

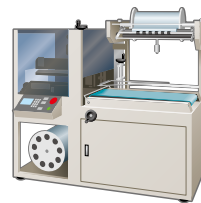

Food packaging machines

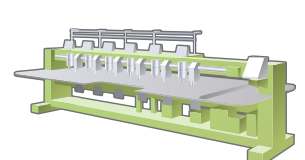

Embroidering machines

All model numbers in this catalog are compliant with the tolerances for specified toxic substances (cadmium, lead, mercury, hexavalent chromium, PBB, and PBDE) found in supplement II of the EU RoHS directive (2011/65/EU), as of the October 2012 production lot. Also, SANMOTION F5 drivers and motors whose model numbers start with "SM" feature standard specifications that are compliant with CE (European Norm) and UL standards.

AC input drivers also comply with the KC Mark standards.



# Lineup

Motor/driver sets are conveniently available in either AC or DC models.

DC models include microstep and full/half step drivers.

Beside the set models, stepping motors can be purchased independently.

The product line includes linear actuator stepping motors with straight line drives, and Stepping motor for vacuum environments.

## Set Models ▶ p. 9-

### AC input (Microstep)



#### Standard models

This is the basic model AC driver/motor set. Standard specifications of both the driver and the motor are compliant with CE (European Norm) and UL standards.

**Motor size:** 42 mm sq./60 mm sq./86 mm sq.

#### Low-backlash gear models

This set employs low backlash conically hobbled gears to engage the output stage of the speed reduction mechanism.

**Motor size:** 42 mm sq./60 mm sq./86 mm sq.  
**Reduction gear ratios:** 1:3.6/1:7.2/1:10/1:20/1:30/1:36

#### Harmonic gear models

This model employs harmonic gears for up to 1:100 resolution.

**Motor size:** 42 mm sq./60 mm sq./86 mm sq.  
**Reduction gear ratios:** 1:30/1:50/1:100

#### Electromagnetic brake models

This set utilizes a non-excitation electromagnetic brake to maintain position in vertical load applications and hold load even during power off.

**Motor size:** 42 mm sq./60 mm sq./86 mm sq.

#### Encoder models

Encoder models are equipped with an encoder (4000 P/R, 3-channel) and can monitor operating status such as position and speed. This simplifies determining causes of vibration and step-out.

**Motor size:** 42 mm sq./60 mm sq./86 mm sq.

### DC input (2 types: microstep and full/half step)

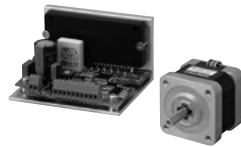

#### Standard models

This is the basic model DC driver/motor set.

**Motor size:** 28 mm sq./42 mm sq./60 mm sq./86 mm sq.

#### Low-backlash gear models

This set employs low backlash conically hobbled gears to engage the output stage of the speed reduction mechanism.

**Motor size:** 42 mm sq./60 mm sq./86 mm sq.  
**Reduction gear ratios:** 1:3.6/1:7.2/1:10/1:20/1:30/1:36

#### Spur gear models

This set employs a spur gear in the speed reduction mechanism.

**Motor size:** 28 mm sq.  
**Reduction gear ratios:** 1:3.6/1:7.2/1:10/1:20/1:30/1:50

#### Harmonic gear models

This model employs harmonic gears for up to 1:100 resolution.

**Motor size:** 28 mm sq./42 mm sq./60 mm sq./86 mm sq.  
**Reduction gear ratios:** 1:30/1:50/1:100

#### Electromagnetic brake models

This set utilizes a non-excitation electromagnetic brake to maintain position in vertical load applications and hold load even during power off.

**Motor size:** 42 mm sq./60 mm sq./86 mm sq.

## Stepping Motors ▶ p. 105-

### Stepping Motors ▶ p. 108-

When ordering a motor only, select from a variety of motor sizes.

A separate driver is required.

**Motor size:** 28 mm sq./42 mm sq./50 mm sq./60 mm sq./86 mm sq.



### Linear Actuator Stepping Motors ▶ p. 115-

This motor employs an integrated ball screw for linear motion.

A separate driver is required.

**Motor size:** 42 mm sq./60 mm sq.



### Stepping Motor for Vacuum Environments ▶ p. 117

We can customize motors for use in low to ultra-high vacuum environments to suit your system requirements.

A separate driver is required.



# Lineup Details

**Set Models** ▶ p. 9–

Series		AC input set models Microstep	DC input set models Microstep	DC input set models Full/half step
Input source		Single phase 100 to 120 VAC Single phase 200 to 240 VAC	24 VDC/48 VDC	24 VDC/36 VDC
Number of divisions		5-phase mode: 1 to 250 2-phase mode: 0.4 to 102.4	5-phase mode: 1 to 250 2-phase mode: 0.4 to 102.4	1 (Full step), 2 (Half step)
Basic step angle		5-phase mode: 0.72° to 0.00288°/pulse 2-phase mode: 1.8° to 0.00703125°/pulse	5-phase mode: 0.72° to 0.00288°/pulse 2-phase mode: 1.8° to 0.00703125°/pulse	Full step 0.72°/pulse Half step 0.36°/pulse
Stepping motor connection method		New pentagon connection	New pentagon connection	New pentagon connection
Model types and corresponding motor sizes (reduction ratios in parentheses)	Standard	42 mm sq./60 mm sq./86 mm sq.	28 mm sq./42 mm sq./60 mm sq./86 mm sq.	28 mm sq./42 mm sq./60 mm sq./86 mm sq.
	Low-backlash gear model	42 mm sq./60 mm sq./86 mm sq. (1:3.6/1:7.2/1:10/1:20/1:30/1:36)	42 mm sq./60 mm sq./86 mm sq. (1:3.6/1:7.2/1:10/1:20/1:30/1:36)	42 mm sq./60 mm sq./86 mm sq. (1:3.6/1:7.2/1:10/1:20/1:30/1:36)
	Spur gear model	—	28 mm sq. (1:3.6/1:7.2/1:10/1:20 /1:30/1:50)	28 mm sq. (1:3.6/1:7.2/1:10/1:20 /1:30/1:50)
	Harmonic gear model	42 mm sq./60 mm sq./86 mm sq. (1:30/1:50/1:100) 1:30 is only available for 42 mm sq.	28 mm sq./42 mm sq./60 mm sq./86 mm sq. (1:30/1:50/1:100) 1:30 is only available for 42 mm sq.	28 mm sq./42 mm sq./60 mm sq./86 mm sq. (1:30/1:50/1:100) 1:30 is only available for 42 mm sq.
	Electromagnetic brake model	42 mm sq./60 mm sq./86 mm sq.	42 mm sq./60 mm sq./86 mm sq.	42 mm sq./60 mm sq./86 mm sq.
	Encoder model	42 mm sq./60 mm sq./86 mm sq.	—	—
Control method		Pulse input, Open loop	Pulse input, Open loop	Pulse input, Open loop
Set configuration items		Driver, Motor, Power supply connector, I/O signal cable (1 m)	Driver, Motor, DC power supply cable (1 m), Motor cable (1 m), I/O signal cable (1 m)	Driver, Motor
Page	System Configuration Diagram	p. 12	p. 52	p. 82
	Set Model Configuration	pp. 14 to 15	p. 54	p. 84
	Specifications/Characteristics Diagram	pp. 17 to 38	pp. 56 to 70	pp. 85 to 99
	Dimensions	pp. 39 to 43	pp. 71 to 74	pp. 71 to 74
	Motor Specifications/Driver Specifications/Safety Standards	pp. 44 to 45	pp. 75 to 77	pp. 75, 100

## Stepping Motors ▶p. 105–

### Stepping Motors ▶p. 108–

Connection method: New pentagon connection

Basic step angle	Motor size	Holding torque (N·m min.)	Model number	Page	
				Specifications/ Characteristics diagram	Dimensions
0.72°	28 mm sq.	0.041 to 0.078	SH528□-72□1	p. 108	p. 108
0.72°	42 mm sq. (CE/UL Model)	0.13 to 0.245	SM542□-□2□1	p. 109	p. 109
0.72°	50 mm sq	0.225 to 0.37	103H650□-73□1	p. 110	p. 110
0.72°	60 mm sq. (CE/UL Model)	0.57 to 1.7	SM560□-□2□1	p. 111	p. 111
0.72°	86 mm sq. (CE/UL Model)	2.3 to 6.8	SM586□-□2□1	p. 112	p. 112

### Linear Actuator Stepping Motors ▶p. 115–

Connection method: New pentagon connection

Motor size	Brake	Rated current (A/phase)	Thrust (N)	Speed (mm/s)	Model number	Page	
						Specifications/ Characteristics diagram	Dimensions
42 mm sq.	Without	0.75	370	48	SL5421-7241	p. 115	p. 116
	With	0.75	370	48	SL5421-72XB41	p. 115	p. 116
60 mm sq.	Without	1.4	450	64	SL5601-8241	p. 115	p. 116
	With	1.4	450	64	SL5601-82XB41	p. 115	p. 116

### Stepping Motors for Vacuum Environments ▶p. 117

We can customize motors for use in low to ultra-high vacuum environments to suit your system requirements. The motors can handle a wide range of vacuum conditions, including low vacuum, high vacuum, and ultra-high vacuum.





# Set Models

AC Input Set Models

▶ p. 12

DC Input Set Models

▶ p. 52

## Features

### Low vibration

AC DC

This driver features approximately 30% less vibration compared with our conventional product\* (when used with an AC input driver).

Also, a low-vibration mode function provides smooth driving, even with one-division (full step) and two-division (half step) coarse resolution settings. This allows vibrations to be suppressed without control system restrictions.

For DC input, set models (microstep) only.

### Settings possible with setup software

AC

Setup software can be used with a personal computer to adjust control parameters, or to analyze alarms and operation status.

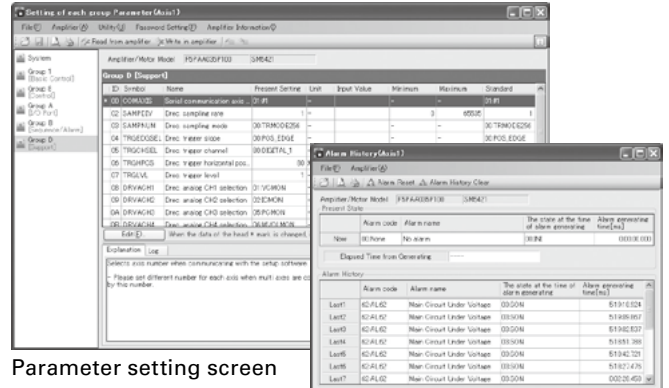

Parameter setting screen

Alarm log screen

### Microstep drive

AC DC

The basic step angle of 0.72° can be set to a resolution of up to 250 divisions in 16 levels. This allows for smooth operation with minimal vibrations.

For DC input, set models (microstep) only.

The AC input driver is equipped with an electronic gear function. Motor resolution can be set according to the ball screw pitch or gear reduction ratio.

### High torque

AC

Torque is increased by approximately 5%\* when combined with our newly developed motors.

As output torque is the same for both 100 and 200 VAC input voltages, there is no need to change motors if power specifications change.

### Compact size

AC

This driver features a 29% reduction in volume compared with our conventional product\*. This makes it easier to use in places where the setup space is limited.

### Rich product lineup

AC

Motors with 4000 P/R high-resolution encoders, electromagnetic brakes, or gears are available as options.

The switch timing for motors with an electromagnetic brake is controlled automatically. An external power supply for the brake is unnecessary.

### Analysis function and device startup support

AC

Using an encoder with the motor makes it possible to monitor information such as the current position and speed. This simplifies determining causes of vibration and step-out.

#### Analysis mode

This mode is suited for device startup and alarm analysis.

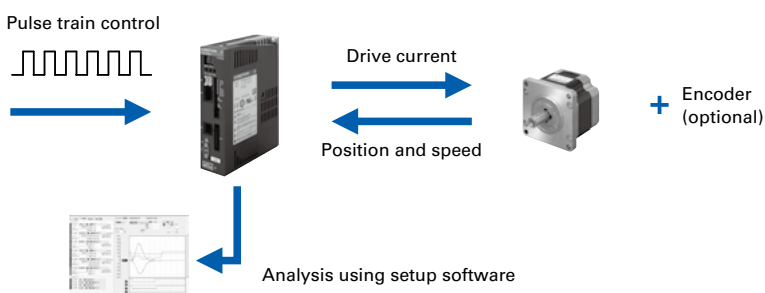

\*Compared with our conventional product, model number: FS1W075P00.

# How To Read the Specifications

## Standard model DC input Driver (Model number: F5PAE140P100) + Standard motor

RoHS

Basic step angle: 0.72° Rated current: 28 mm sq. Motor 0.75 A/phase, 42 mm sq. to 86 mm sq. Motor 1.4 A/phase

		28 mm sq.		42 mm sq.	
		32 mm	51.5 mm	35 mm	41 mm
Motor size					
Motor length					
Single shaft	Set model number	FAF521S	FAF525S	FAF541S	FAF542S
	Configuration item: motor model number	SH5281-7241	SH5285-7241	SF5421-8241	SF5422-8241
Dual shaft	Set model number	FAF521D	FAF525D	FAF541D	FAF542D
	Configuration item: motor model number	SH5281-7211	SH5285-7211	SF5421-8211	SF5422-8211
Holding torque	N·m min.	0.041	0.078	0.125	0.185
Rotor inertia	×10 <sup>-4</sup> kg·m <sup>2</sup>	0.01	0.022	0.028	0.045
Motor mass *1	kg	0.11	0.2	0.24	0.31
Allowable thrust load	N	3	3	10	10
Allowable radial load *2	N	42	49	56	54

\*1 Driver mass ▶ p. 77

\*2 The load point is at the tip of the output shaft.

## Characteristics diagram

With rubber coupling

Pull-out torque ——— Source current (no load) - - - - - Source current (load applied) ······  
fs: Maximum self-start frequency when not loaded ●

FAF521S  
FAF521D

Winding current:  
0.75 A/phase

24VDC

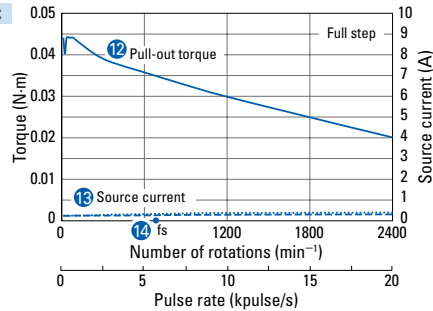

48VDC

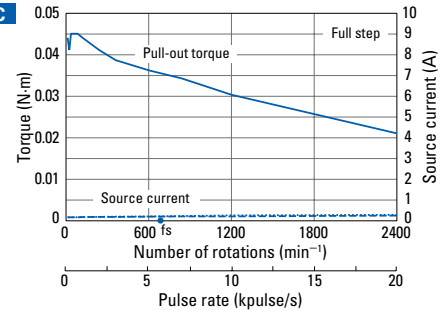

- Model number of the driver included in the set.
- When driving in full step mode, the basic step angle is the rotation angle with each pulse. When driving in half step mode, the motor rotates at half of the basic step angle.
- This is the rated current that flows to the motor winding.
- Size and length of the stepping motor included in the set.
- The set model number and the model number of the stepping motor included in the set. The model number for the stepping motor shaft varies for single shaft and dual shaft.
- This is the maximum torque that occurs when using 4-phase excitation at rated current, causing the shaft to rotate from the outside.
- This is the moment of inertia of the rotor.
- This is the mass of the stepping motor.
- This is the allowable load when applying a load to the shaft in the axial direction. Do not exceed this value when using this product.
- This is the allowable load when applying a load to the shaft perpendicular to the axial direction. Do not exceed this value when using this product.
- This graph shows the relationship between the pulse rate (frequency), speed, and torque. The driver source current is shown in addition to the torque.

- The pull-out torque is the maximum torque in which synchronized operation is possible for a certain command pulse. If a torque that exceeds this value is applied to the stepping motor, it will be unable to synchronize with the command pulse (Step-out). Thus, when selecting a motor, you should allow for a torque margin of 1.4 to 2 times, in order to avoid step-out.
- This graph shows the current value for the power supply that supplies the driver.

- - - - - The blue dashed line shows the source current value when there is no load (motor by itself).

····· The blue dotted line shows the source current value when the maximum torque is applied to the stepping motor (during load).

The required power supply capacity (W) is calculated from this graph.

- The blue-colored dots in the lower part of the graph show the upper limit for the self-start frequency (maximum self-start frequency: fs) of the stepping motor by itself (no load). The stepping motor will not operate normally if it is started using frequencies that exceed these values. For this reason, it is necessary to start the stepping motor using frequencies that are lower than these values. The maximum self-start frequency (fL) which includes the load can be determined using the relational expression below.

$$f_L = \frac{f_s}{\sqrt{1 + \frac{J_L}{J_M}}}$$

J<sub>M</sub>: Rotor inertia

J<sub>L</sub>: Load inertia

f<sub>s</sub>: Maximum self-start frequency when not loaded

# AC Input Set Models/Drivers

## Microstep

Set Model Configuration ▶ pp. 14 to 15 Specifications/Characteristics Diagram ▶ pp. 17 to 38 Motor Dimensions ▶ pp. 39 to 43  
 Motor Specifications ▶ p. 44 Driver Dimensions ▶ p. 45 Driver Specifications ▶ p. 45



### Set configuration items RoHS

#### Driver



Model number: F5PA□0□5P100

Power supply: Single phase 100 to 120 VAC,  
 Single phase 200 to 240 VAC

- The operation manual can be downloaded from our website.
- Drivers are available for separate purchase.

#### Motor



New pentagon connection

Motor size: 42 mm sq., 60 mm sq., 86 mm sq.

#### Connector

For power supply

#### Cable

For I/O signal cable (1 m)

## System Configuration Diagram

- ① Power supply connector CN1  
 (set configuration items; model number: FC6P0000A)
- ② I/O signal cable (1 m)  
 (set configuration items; model number: FC5S0010A)
- ③ Motor extension cable (option, sold separately)
- ④ Encoder extension cable (option, sold separately)
- ⑤ Connector unit for setup software  
 (option, sold separately)

Single phase 100 to 120 VAC  
 or 200 to 240 VAC

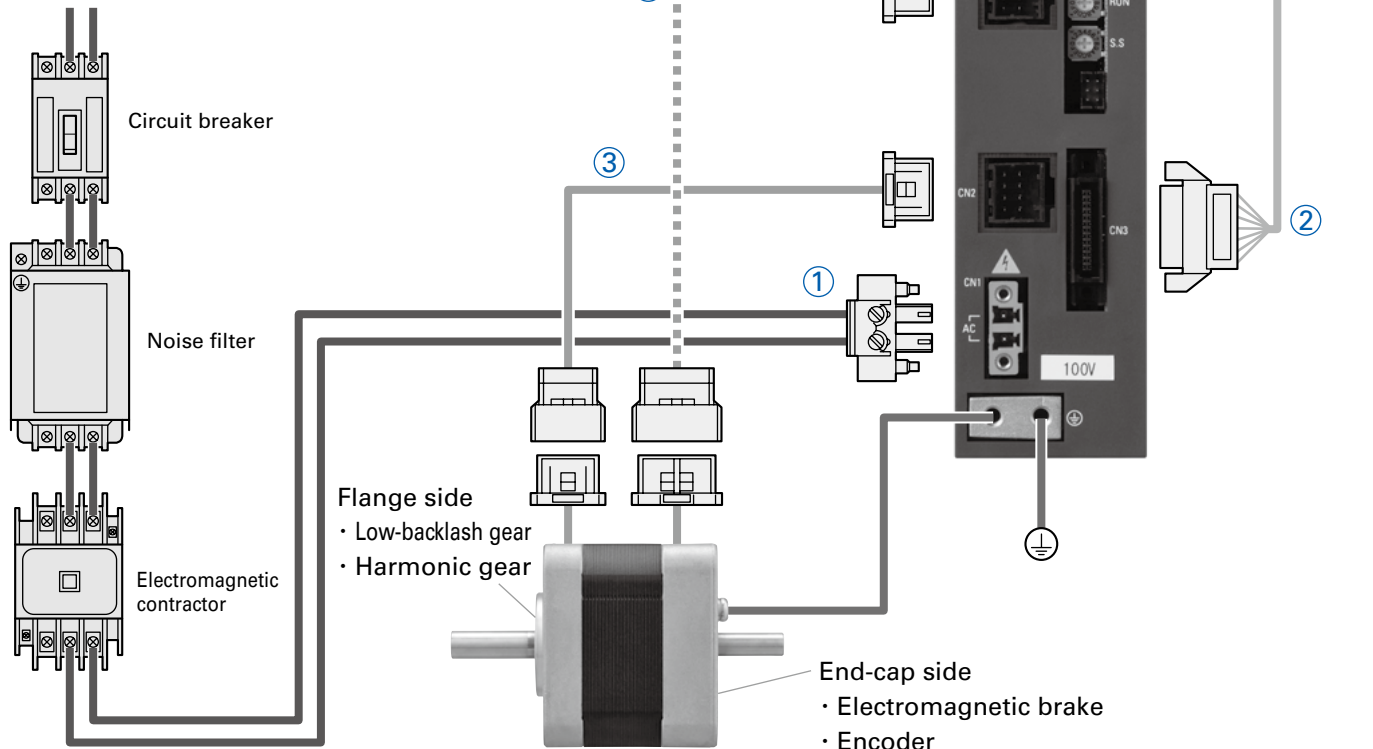

# Set Model Numbering Convention

Not every combination of the following codes or characters is available. Check the set model component details on the following page for the model number combinations, or contact us.

Example: This is a set model number for a 100 VAC input driver and motor (model number: SM5421-32CXA40).

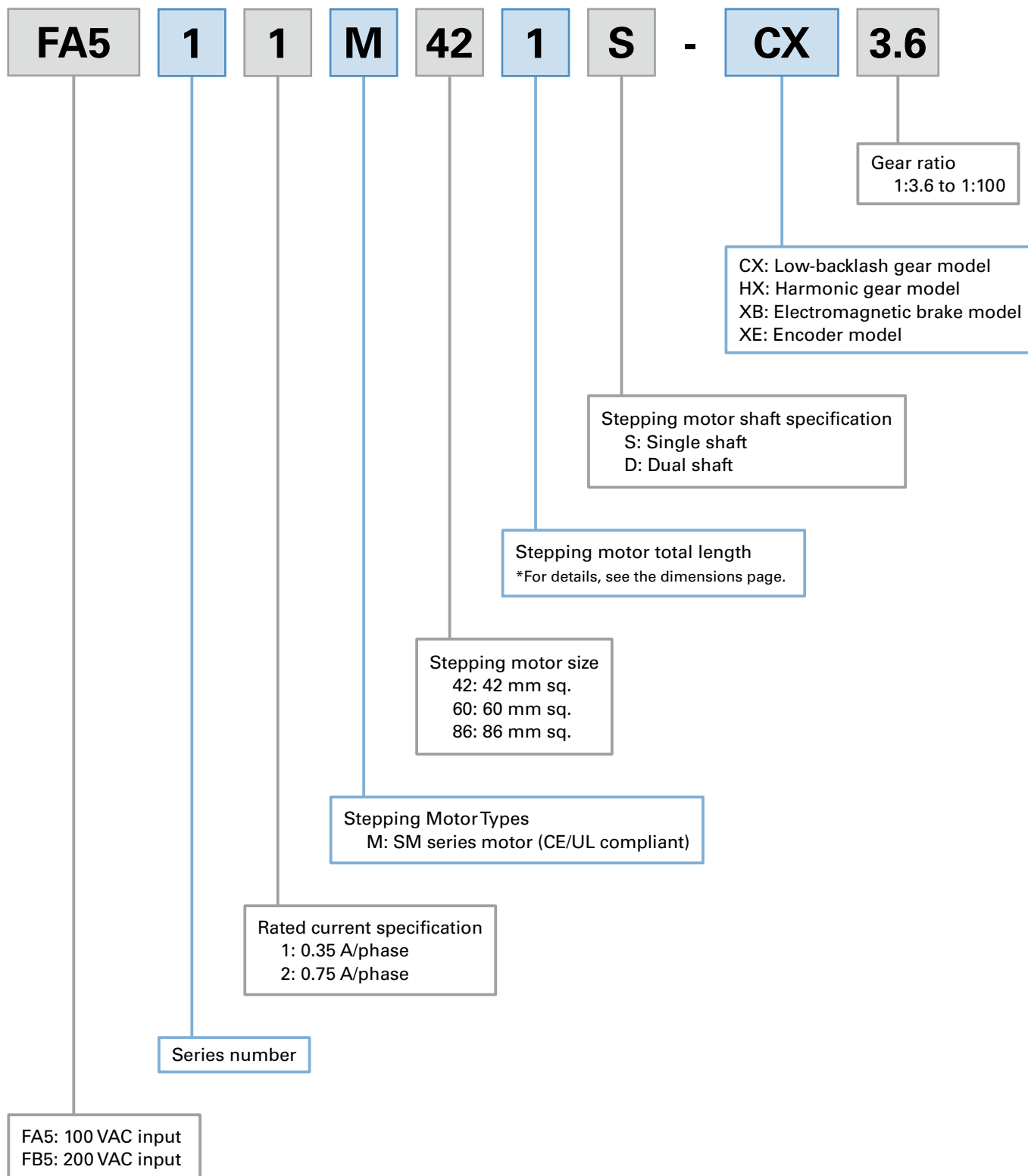

# Set Model Configuration

This set includes the driver, motor, power supply connector, and an I/O signal cable.

Basic step angle: 0.72°

100 VAC										
Model	Motor size	Single shaft			Dual shaft			Rated current (A/phase)	Page	
		Set model number	Set configuration items (Connectors and cables are listed below the table)		Set model number	Set configuration items (Connectors and cables are listed below the table)			Specifications	Dimensions
			Motor	Driver		Motor	Driver			
Standard models	42 mm sq.	FA511M421S	SM5421-3240	F5PAA035P100	FA511M421D	SM5421-3210	F5PAA035P100	0.35	p. 17	p. 39
		FA511M422S	SM5422-3240		FA511M422D	SM5422-3210			p. 17	p. 39
		FA511M423S	SM5423-3240		FA511M423D	SM5423-3210			p. 17	p. 39
	60 mm sq.	FA512M601S	SM5601-7240	F5PAA075P100	FA512M601D	SM5601-7210	F5PAA075P100	0.75	p. 17	p. 39
		FA512M602S	SM5602-7240		FA512M602D	SM5602-7210			p. 17	p. 39
		FA512M603S	SM5603-7240		FA512M603D	SM5603-7210			p. 17	p. 39
	86 mm sq.	FA512M861S	SM5861-7240	F5PAA075P100	FA512M861D	SM5861-7210	F5PAA075P100	0.75	p. 18	p. 39
		FA512M862S	SM5862-7240		FA512M862D	SM5862-7210			p. 18	p. 39
		FA512M863S	SM5863-7240		FA512M863D	SM5863-7210			p. 18	p. 39
Low-backlash gear models	42 mm sq.	FA511M421S-CX3.6	SM5421-32CXA40	F5PAA035P100	FA511M421D-CX3.6	SM5421-32CXA10	F5PAA035P100	0.35	p. 19	p. 39
		FA511M421S-CX7.2	SM5421-32CXB40		FA511M421D-CX7.2	SM5421-32CXB10			p. 19	p. 39
		FA511M421S-CX10	SM5421-32CXE40		FA511M421D-CX10	SM5421-32CXE10			p. 19	p. 39
		FA511M421S-CX20	SM5421-32CXG40		FA511M421D-CX20	SM5421-32CXG10			p. 19	p. 39
		FA511M421S-CX30	SM5421-32CXJ40		FA511M421D-CX30	SM5421-32CXJ10			p. 19	p. 39
		FA511M421S-CX36	SM5421-32CXX40		FA511M421D-CX36	SM5421-32CXX10			p. 19	p. 39
	60 mm sq.	FA512M601S-CX3.6	SM5601-72CXA40	F5PAA075P100	FA512M601D-CX3.6	SM5601-72CXA10	F5PAA075P100	0.75	p. 20	p. 39
		FA512M601S-CX7.2	SM5601-72CXB40		FA512M601D-CX7.2	SM5601-72CXB10			p. 20	p. 39
		FA512M601S-CX10	SM5601-72CXE40		FA512M601D-CX10	SM5601-72CXE10			p. 20	p. 39
		FA512M601S-CX20	SM5601-72CXG40		FA512M601D-CX20	SM5601-72CXG10			p. 20	p. 39
		FA512M601S-CX30	SM5601-72CXJ40		FA512M601D-CX30	SM5601-72CXJ10			p. 20	p. 39
		FA512M601S-CX36	SM5601-72CXX40		FA512M601D-CX36	SM5601-72CXX10			p. 20	p. 39
	86 mm sq.	FA512M861S-CX3.6	SM5861-72CXA40	F5PAA075P100	FA512M861D-CX3.6	SM5861-72CXA10	F5PAA075P100	0.75	p. 21	p. 40
		FA512M861S-CX7.2	SM5861-72CXB40		FA512M861D-CX7.2	SM5861-72CXB10			p. 21	p. 40
		FA512M861S-CX10	SM5861-72CXE40		FA512M861D-CX10	SM5861-72CXE10			p. 21	p. 40
		FA512M861S-CX20	SM5861-72CXG40		FA512M861D-CX20	SM5861-72CXG10			p. 21	p. 40
		FA512M861S-CX30	SM5861-72CXJ40		FA512M861D-CX30	SM5861-72CXJ10			p. 21	p. 40
		FA512M861S-CX36	SM5861-72CXX40		FA512M861D-CX36	SM5861-72CXX10			p. 21	p. 40
Harmonic gear models	42 mm sq.	FA511M421S-HX30	SM5421-32HXJ40	F5PAA035P100	FA511M421D-HX30	SM5421-32HXJ10	F5PAA035P100	0.35	p. 22	p. 40
		FA511M421S-HX50	SM5421-32HXL40		FA511M421D-HX50	SM5421-32HXL10			p. 22	p. 40
		FA511M421S-HX100	SM5421-32HXM40		FA511M421D-HX100	SM5421-32HXM10			p. 22	p. 40
	60 mm sq.	FA512M601S-HX50	SM5601-72HXL40	F5PAA075P100	FA512M601D-HX50	SM5601-72HXL10	F5PAA075P100	0.75	p. 22	p. 41
		FA512M601S-HX100	SM5601-72HXM40		FA512M601D-HX100	SM5601-72HXM10			p. 22	p. 41
		FA512M861S-HX50	SM5861-72HXL40		FA512M861D-HX50	SM5861-72HXL10			p. 23	p. 41
86 mm sq.	FA512M861S-HX100	SM5861-72HXM40	F5PAA075P100	FA512M861D-HX100	SM5861-72HXM10	F5PAA075P100	0.75	p. 23	p. 41	
Electromagnetic brake models	42 mm sq.	FA511M421S-XB	SM5421-32XB40	F5PAA035P100	—	—	—	0.35	p. 24	p. 42
		FA511M422S-XB	SM5422-32XB40		—	—			p. 24	p. 42
		FA511M423S-XB	SM5423-32XB40		—	—			p. 24	p. 42
	60 mm sq.	FA512M601S-XB	SM5601-72XB40	F5PAA075P100	—	—	—	0.75	p. 24	p. 42
		FA512M602S-XB	SM5602-72XB40		—	—			p. 24	p. 42
		FA512M603S-XB	SM5603-72XB40		—	—			p. 24	p. 42
	86 mm sq.	FA512M861S-XB	SM5861-72XB40	F5PAA075P100	—	—	—	0.75	p. 25	p. 42
		FA512M862S-XB	SM5862-72XB40		—	—			p. 25	p. 42
		FA512M863S-XB	SM5863-72XB40		—	—			p. 25	p. 42
Encoder models	42 mm sq.	FA511M421S-XE	SM5421-32XE40	F5PAA035P100	—	—	—	0.35	p. 26	p. 42
		FA511M422S-XE	SM5422-32XE40		—	—			p. 26	p. 42
		FA511M423S-XE	SM5423-32XE40		—	—			p. 26	p. 42
	60 mm sq.	FA512M601S-XE	SM5601-72XE40	F5PAA075P100	—	—	—	0.75	p. 26	p. 43
		FA512M602S-XE	SM5602-72XE40		—	—			p. 26	p. 43
		FA512M603S-XE	SM5603-72XE40		—	—			p. 26	p. 43
	86 mm sq.	FA512M861S-XE	SM5861-72XE40	F5PAA075P100	—	—	—	0.75	p. 27	p. 43
		FA512M862S-XE	SM5862-72XE40		—	—			p. 27	p. 43
		FA512M863S-XE	SM5863-72XE40		—	—			p. 27	p. 43

· Encoder specifications are 4000 P/R and 3-channel.  
 · All motors above are lead wires with connectors.

### Power supply connector (CN1)

Model number	Manufacturer model number	Manufacturer
FC6P0000A	MC1, 5/2-STF-5, 08	PHOENIX CONTACT

### I/O signal cable (CN3), 1 m

Model number
FC5S0010A



# Set Model Configuration

This set includes the driver, motor, power supply connector, and an I/O signal cable.

Basic step angle: 0.72°

200 VAC								Basic step angle: 0.72°		
Model	Motor size	Single shaft			Dual shaft			Rated current (A/phase)	Page	
		Set model number	Set configuration items (Connectors and cables are listed below the table)		Set model number	Set configuration items (Connectors and cables are listed below the table)			Specifi- cations	Dimen- sions
			Motor	Driver		Motor	Driver			
Standard models	42 mm sq.	FB511M421S	SM5421-3240	F5PAB035P100	FB511M421D	SM5421-3210	F5PAB035P100	0.35	p. 28	p. 39
		FB511M422S	SM5422-3240		FB511M422D	SM5422-3210			p. 28	p. 39
		FB511M423S	SM5423-3240		FB511M423D	SM5423-3210			p. 28	p. 39
	60 mm sq.	FB512M601S	SM5601-7240	F5PAB075P100	FB512M601D	SM5601-7210	F5PAB075P100	0.75	p. 28	p. 39
		FB512M602S	SM5602-7240		FB512M602D	SM5602-7210			p. 28	p. 39
		FB512M603S	SM5603-7240		FB512M603D	SM5603-7210			p. 28	p. 39
	86 mm sq.	FB512M861S	SM5861-7240	F5PAB075P100	FB512M861D	SM5861-7210	F5PAB075P100	0.75	p. 29	p. 39
		FB512M862S	SM5862-7240		FB512M862D	SM5862-7210			p. 29	p. 39
		FB512M863S	SM5863-7240		FB512M863D	SM5863-7210			p. 29	p. 39
Low-backlash gear models	42 mm sq.	FB511M421S-CX3.6	SM5421-32CXA40	F5PAB035P100	FB511M421D-CX3.6	SM5421-32CXA10	F5PAB035P100	0.35	p. 30	p. 39
		FB511M421S-CX7.2	SM5421-32CXB40		FB511M421D-CX7.2	SM5421-32CXB10			p. 30	p. 39
		FB511M421S-CX10	SM5421-32CXE40		FB511M421D-CX10	SM5421-32CXE10			p. 30	p. 39
		FB511M421S-CX20	SM5421-32CXG40		FB511M421D-CX20	SM5421-32CXG10			p. 30	p. 39
		FB511M421S-CX30	SM5421-32CXJ40		FB511M421D-CX30	SM5421-32CXJ10			p. 30	p. 39
		FB511M421S-CX36	SM5421-32CXX40		FB511M421D-CX36	SM5421-32CXX10			p. 30	p. 39
	60 mm sq.	FB512M601S-CX3.6	SM5601-72CXA40	F5PAB075P100	FB512M601D-CX3.6	SM5601-72CXA10	F5PAB075P100	0.75	p. 31	p. 39
		FB512M601S-CX7.2	SM5601-72CXB40		FB512M601D-CX7.2	SM5601-72CXB10			p. 31	p. 39
		FB512M601S-CX10	SM5601-72CXE40		FB512M601D-CX10	SM5601-72CXE10			p. 31	p. 39
		FB512M601S-CX20	SM5601-72CXG40		FB512M601D-CX20	SM5601-72CXG10			p. 31	p. 39
		FB512M601S-CX30	SM5601-72CXJ40		FB512M601D-CX30	SM5601-72CXJ10			p. 31	p. 39
		FB512M601S-CX36	SM5601-72CXX40		FB512M601D-CX36	SM5601-72CXX10			p. 31	p. 39
	86 mm sq.	FB512M861S-CX3.6	SM5861-72CXA40	F5PAB075P100	FB512M861D-CX3.6	SM5861-72CXA10	F5PAB075P100	0.75	p. 32	p. 40
		FB512M861S-CX7.2	SM5861-72CXB40		FB512M861D-CX7.2	SM5861-72CXB10			p. 32	p. 40
		FB512M861S-CX10	SM5861-72CXE40		FB512M861D-CX10	SM5861-72CXE10			p. 32	p. 40
		FB512M861S-CX20	SM5861-72CXG40		FB512M861D-CX20	SM5861-72CXG10			p. 32	p. 40
		FB512M861S-CX30	SM5861-72CXJ40		FB512M861D-CX30	SM5861-72CXJ10			p. 32	p. 40
		FB512M861S-CX36	SM5861-72CXX40		FB512M861D-CX36	SM5861-72CXX10			p. 32	p. 40
Harmonic gear models	42 mm sq.	FB511M421S-HX30	SM5421-32HXJ40	F5PAB035P100	FB511M421D-HX30	SM5421-32HXJ10	F5PAB035P100	0.35	p. 33	p. 40
		FB511M421S-HX50	SM5421-32HXL40		FB511M421D-HX50	SM5421-32HXL10			p. 33	p. 40
		FB511M421S-HX100	SM5421-32HXM40		FB511M421D-HX100	SM5421-32HXM10			p. 33	p. 40
	60 mm sq.	FB512M601S-HX50	SM5601-72HXL40	F5PAB075P100	FB512M601D-HX50	SM5601-72HXL10	F5PAB075P100	0.75	p. 33	p. 41
		FB512M601S-HX100	SM5601-72HXM40		FB512M601D-HX100	SM5601-72HXM10			p. 33	p. 41
		FB512M861S-HX50	SM5861-72HXL40		FB512M861D-HX50	SM5861-72HXL10			p. 34	p. 41
86 mm sq.	FB512M861S-HX100	SM5861-72HXM40	F5PAB075P100	FB512M861D-HX100	SM5861-72HXM10	F5PAB075P100	0.75	p. 34	p. 41	
Electromagnetic brake models	42 mm sq.	FB511M421S-XB	SM5421-32XB40	F5PAB035P100	—	—	—	0.35	p. 35	p. 42
		FB511M422S-XB	SM5422-32XB40		—	—			p. 35	p. 42
		FB511M423S-XB	SM5423-32XB40		—	—			p. 35	p. 42
	60 mm sq.	FB512M601S-XB	SM5601-72XB40	F5PAB075P100	—	—	—	0.75	p. 35	p. 42
		FB512M602S-XB	SM5602-72XB40		—	—			p. 35	p. 42
		FB512M603S-XB	SM5603-72XB40		—	—			p. 35	p. 42
	86 mm sq.	FB512M861S-XB	SM5861-72XB40	F5PAB075P100	—	—	—	0.75	p. 36	p. 42
		FB512M862S-XB	SM5862-72XB40		—	—			p. 36	p. 42
		FB512M863S-XB	SM5863-72XB40		—	—			p. 36	p. 42
Encoder models	42 mm sq.	FB511M421S-XE	SM5421-32XE40	F5PAB035P100	—	—	—	0.35	p. 37	p. 42
		FB511M422S-XE	SM5422-32XE40		—	—			p. 37	p. 42
		FB511M423S-XE	SM5423-32XE40		—	—			p. 37	p. 42
	60 mm sq.	FB512M601S-XE	SM5601-72XE40	F5PAB075P100	—	—	—	0.75	p. 37	p. 43
		FB512M602S-XE	SM5602-72XE40		—	—			p. 37	p. 43
		FB512M603S-XE	SM5603-72XE40		—	—			p. 37	p. 43
	86 mm sq.	FB512M861S-XE	SM5861-72XE40	F5PAB075P100	—	—	—	0.75	p. 38	p. 43
		FB512M862S-XE	SM5862-72XE40		—	—			p. 38	p. 43
		FB512M863S-XE	SM5863-72XE40		—	—			p. 38	p. 43

· Encoder specifications are 4000 P/R and 3-channel.  
 · All motors above are lead wires with connectors.

## Power supply connector (CN1)

Model number	Manufacturer model number	Manufacturer
FC6P0000A	MC1, 5/2-STF-5, 08	PHOENIX CONTACT

## I/O signal cable (CN3), 1 m

Model number
FC5S0010A

## Set configuration items

### Power supply connector (CN1)

Model number	Manufacturer model number	Manufacturer
FC6P0000A	MC1, 5/2-STF-5, 08	PHOENIX CONTACT

### I/O signal cable (CN3), 1 m

Model number
FC5S0010A

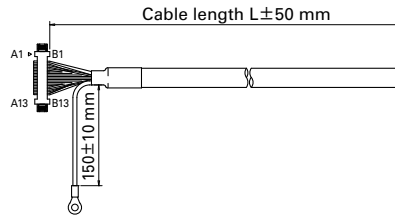

## Options (sold separately)

### Motor extension connector set Model number: FC6M0000A

Manufacturer	Name	Manufacturer model number	Quantity
Tyco Electronics Japan G.K.	Recessed housing	1-1827864-4	1
	Recessed contact	1827572-2	7
	Tab housing	1-1903130-4	1
	Tab contact	1903114-2	7

### Motor extension cable (also used for brake)

Model number	Cable length (L)
FC6M0010A (for 42 mm sq. and 60 mm sq.), FC6M0010B (for 86 mm sq.)	1 m
FC6M0020A (for 42 mm sq. and 60 mm sq.), FC6M0020B (for 86 mm sq.)	2 m
FC6M0030A (for 42 mm sq. and 60 mm sq.), FC6M0030B (for 86 mm sq.)	3 m

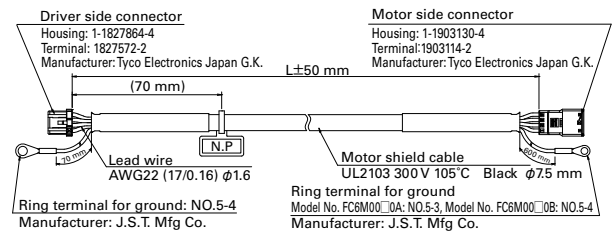

### Encoder extension connector set Model number: FC5E0000A

Manufacturer	Name	Manufacturer model number	Quantity
Tyco Electronics Japan G.K.	Recessed housing	1-1827864-6	1
	Recessed contact	1827570-2	10
	Tab housing	1-1903130-6	1
	Tab contact	1903112-2	10

### Encoder extension cable

Model number	Cable length (L)
FC5E0010A	1 m
FC5E0020A	2 m
FC5E0030A	3 m

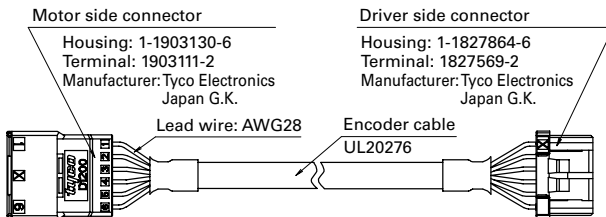

### Connector for I/O signals Model number: FC5S0000A

Manufacturer	Name	Manufacturer model number	Quantity
KEL CORPORATION	Connector	8822E-026-171D-F	1

### I/O signal cable

Model number	Cable length (L)
FC5S0010A	1 m
FC5S0020A	2 m

Dimensions are the same as the set configuration item diagram.

### Connector unit for setup software Model number: PBFM-U6

Name	Manufacturer model number	Quantity
USB/RS-485 converter	Uport 1130 (manufactured by MOXA)	1
Cable	PBC6T0005A (0.5m)	1

Refer to the included installation manual (CD-ROM) or the manufacturer's website for instructions on installing the Uport 1130 driver or details on its use.

- Contact us if you need a different cable length than those listed here.
- Contact us if you need a robot cable.
- Special crimping and pressure welding tools are required to assemble the harness. Refer to the manufacturer of the individual connectors for details.
- Refer to p. 48 to 49 for compatible wires, model number details, and connector pin arrangements.

### Setup software (free)

Name	SANMOTION MOTOR SETUP SOFTWARE
Compatible operating systems	Windows XP (SP3 or higher)/Vista/7/8

The software can be downloaded from the Product Information page on our website. URL: <http://www.sanyodenki.com>



Basic step angle: 0.72°

Size	Motor size	42 mm sq.			60 mm sq.		
		35 mm	41 mm	49 mm	49 mm	60 mm	89 mm
Single shaft	Set model number	FA511M421S	FA511M422S	FA511M423S	FA512M601S	FA512M602S	FA512M603S
	Configuration item: motor model number	SM5421-3240	SM5422-3240	SM5423-3240	SM5601-7240	SM5602-7240	SM5603-7240
	Configuration item: driver model number	F5PAA035P100	F5PAA035P100	F5PAA035P100	F5PAA075P100	F5PAA075P100	F5PAA075P100
Dual shaft	Set model number	FA511M421D	FA511M422D	FA511M423D	FA512M601D	FA512M602D	FA512M603D
	Configuration item: motor model number	SM5421-3210	SM5422-3210	SM5423-3210	SM5601-7210	SM5602-7210	SM5603-7210
	Configuration item: driver model number	F5PAA035P100	F5PAA035P100	F5PAA035P100	F5PAA075P100	F5PAA075P100	F5PAA075P100
Holding torque	N·m min.	0.13	0.185	0.245	0.57	0.9	1.7
Rotor inertia	×10 <sup>-4</sup> kg·m <sup>2</sup>	0.028	0.045	0.056	0.2	0.31	0.6
Rated current	A/phase	0.35	0.35	0.35	0.75	0.75	0.75
Motor mass *1	kg	0.24	0.31	0.38	0.62	0.8	1.27
Allowable thrust load	N	10	10	10	20	20	20
Allowable radial load *2	N	56	54	52	191	183	170

\*1 Driver mass ▶ p. 45

\*2 The load point is at the tip of the output shaft.

### Characteristics diagram

With rubber coupling

Pull-out torque ———  
fs: Maximum self-start frequency when not loaded ●

Source current (no load) - - - - -

Source current (load applied) ······

#### FA511M421S FA511M421D

Winding current:  
0.35 A/phase

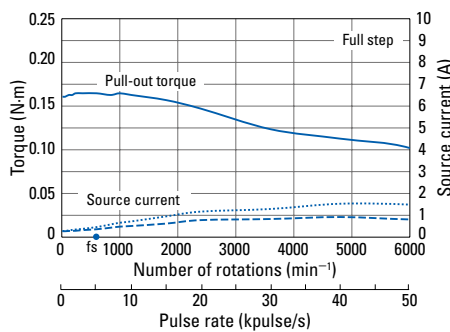

#### FA511M422S FA511M422D

Winding current:  
0.35 A/phase

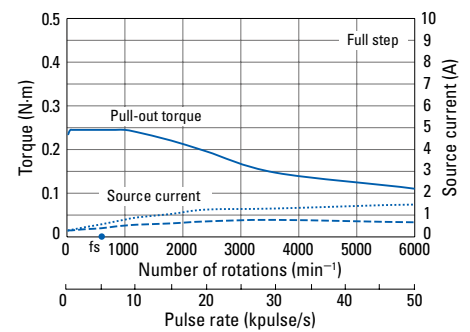

#### FA511M423S FA511M423D

Winding current:  
0.35 A/phase

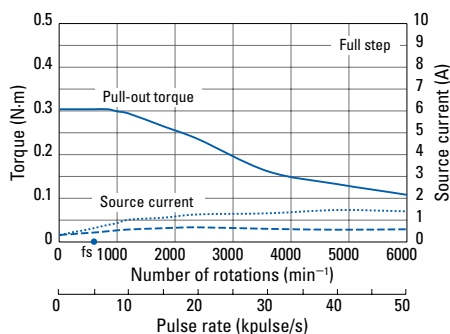

#### FA512M601S FA512M601D

Winding current:  
0.75 A/phase

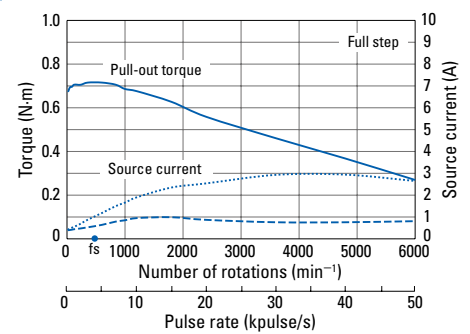

#### FA512M602S FA512M602D

Winding current:  
0.75 A/phase

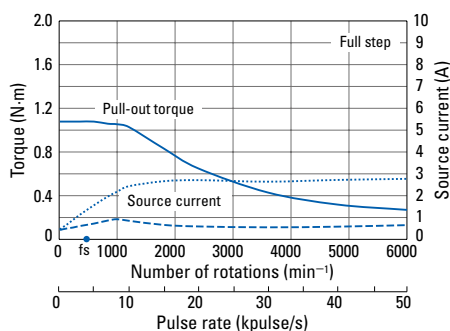

#### FA512M603S FA512M603D

Winding current:  
0.75 A/phase

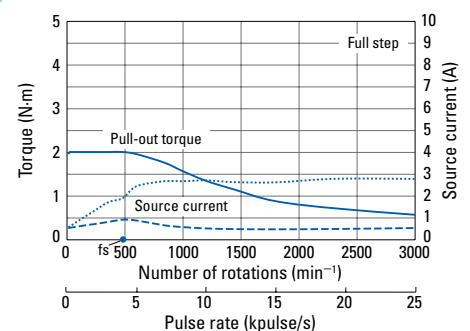

Basic step angle: 0.72°

Size		86 mm sq.		
		66 mm	96.5 mm	127 mm
Single shaft	Motor size			
	Motor length			
	Set model number	<b>FA512M861S</b>	<b>FA512M862S</b>	<b>FA512M863S</b>
Dual shaft	Configuration item: motor model number	SM5861-7240	SM5862-7240	SM5863-7240
	Configuration item: driver model number	F5PAA075P100	F5PAA075P100	F5PAA075P100
	Set model number	<b>FA512M861D</b>	<b>FA512M862D</b>	<b>FA512M863D</b>
Dual shaft	Configuration item: motor model number	SM5861-7210	SM5862-7210	SM5863-7210
	Configuration item: driver model number	F5PAA075P100	F5PAA075P100	F5PAA075P100
	Set model number	<b>FA512M861D</b>	<b>FA512M862D</b>	<b>FA512M863D</b>
Holding torque	N·m min.	2.3	4.4	6.8
Rotor inertia	×10 <sup>-4</sup> ·kg·m <sup>2</sup>	1.48	3	4.5
Rated current	A/phase	0.75	0.75	0.75
Motor mass *1	kg	1.75	2.9	4
Allowable thrust load	N	60	60	60
Allowable radial load *2	N	200	200	200

\*1 Driver mass ▶ p. 45

\*2 The load point is at the tip of the output shaft.

### Characteristics diagram

Winding current: 0.75A/phase  
With rubber coupling

Pull-out torque ———  
fs: Maximum self-start frequency when not loaded ●

Source current (no load) - - - - -

Source current (load applied) ······

**FA512M861S**  
**FA512M861D**

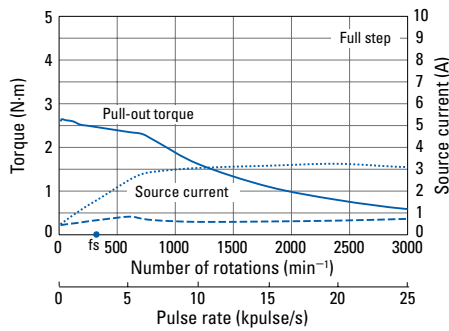

**FA512M862S**  
**FA512M862D**

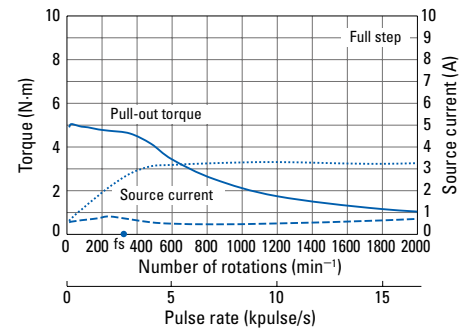

**FA512M863S**  
**FA512M863D**

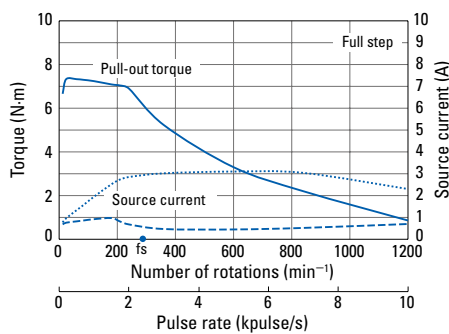

Size	Motor size	42 mm sq.					
	Motor + gear length	65.4 mm					
Single shaft	Set model number	<b>FA511M421S-CX3.6</b>	<b>FA511M421S-CX7.2</b>	<b>FA511M421S-CX10</b>	<b>FA511M421S-CX20</b>	<b>FA511M421S-CX30</b>	<b>FA511M421S-CX36</b>
	Configuration item: motor model number	SM5421-32CXA40	SM5421-32CXB40	SM5421-32CXE40	SM5421-32CXG40	SM5421-32CXJ40	SM5421-32CXK40
	Configuration item: driver model number	F5PAA035P100	F5PAA035P100	F5PAA035P100	F5PAA035P100	F5PAA035P100	F5PAA035P100
Dual shaft	Set model number	<b>FA511M421D-CX3.6</b>	<b>FA511M421D-CX7.2</b>	<b>FA511M421D-CX10</b>	<b>FA511M421D-CX20</b>	<b>FA511M421D-CX30</b>	<b>FA511M421D-CX36</b>
	Configuration item: motor model number	SM5421-32CXA10	SM5421-32CXB10	SM5421-32CXE10	SM5421-32CXG10	SM5421-32CXJ10	SM5421-32CXK10
	Configuration item: driver model number	F5PAA035P100	F5PAA035P100	F5PAA035P100	F5PAA035P100	F5PAA035P100	F5PAA035P100
Allowable torque	N·m	0.343	0.686	1	1.5	1.5	1.5
Rotor inertia	×10 <sup>-4</sup> kg·m <sup>2</sup>	0.028	0.028	0.028	0.028	0.028	0.028
Rated current	A/phase	0.35	0.35	0.35	0.35	0.35	0.35
Basic step angle	°	0.2	0.1	0.072	0.036	0.024	0.02
Gear ratio	—	1:3.6	1:7.2	1:10	1:20	1:30	1:36
Backlash	° or less	0.6	0.4	0.35	0.25	0.25	0.25
Allowable speed	min <sup>-1</sup>	500	250	180	90	60	50
Motor mass *1	kg	0.37	0.37	0.37	0.37	0.37	0.37
Allowable thrust load	N	15	15	15	15	15	15
Allowable radial load *2	N	20	20	20	20	20	20

Note: Directions of motor rotation and gear output shaft rotation are the same for models with reduction ratios 1:3.6, 1:7.2 and 1:10, and opposite for reduction ratios 1:20, 1:30, and 1:36.

\*1 Driver mass ▶ p. 45

\*2 When load is applied at 1/3 length from output shaft edge.

### Characteristics diagram

Winding current: 0.35A/phase

Allowable torque ——— Source current (no load) - - - - - Source current (load applied) ······  
fs: Maximum self-start frequency when not loaded ●

**FA511M421S-CX3.6**  
**FA511M421D-CX3.6**

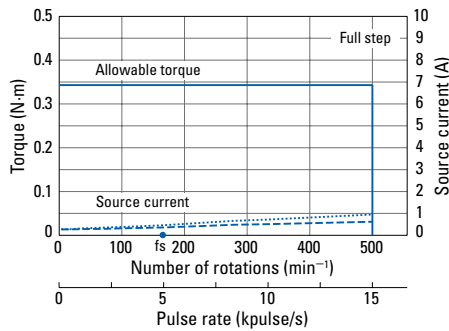

**FA511M421S-CX7.2**  
**FA511M421D-CX7.2**

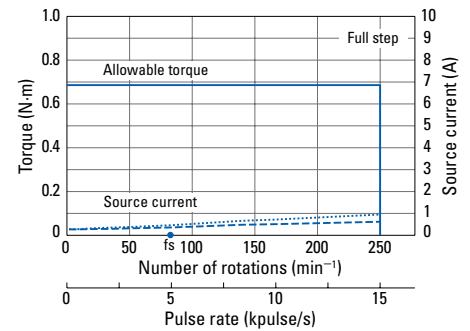

**FA511M421S-CX10**  
**FA511M421D-CX10**

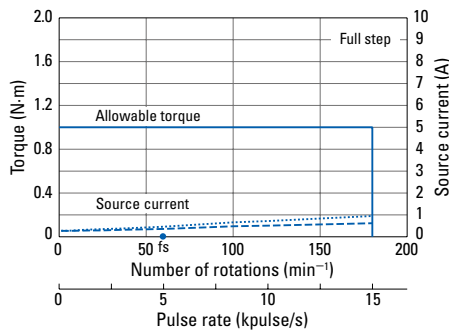

**FA511M421S-CX20**  
**FA511M421D-CX20**

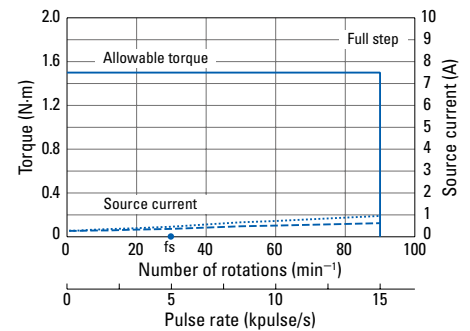

**FA511M421S-CX30**  
**FA511M421D-CX30**

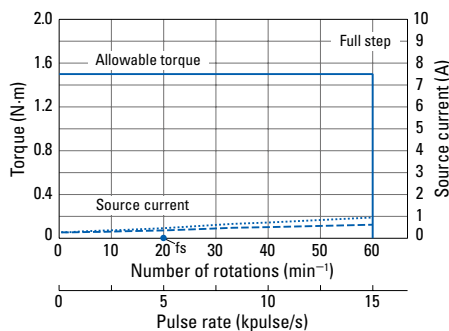

**FA511M421S-CX36**  
**FA511M421D-CX36**

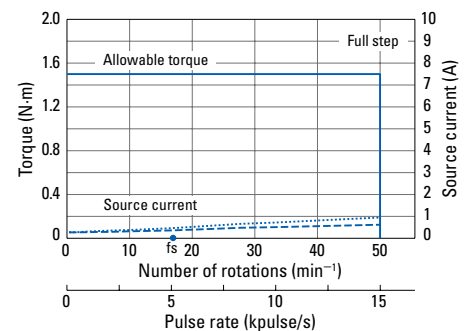

System Configuration Diagram ▶ p. 12 Set Model Configuration ▶ pp. 14 to 15 Motor Dimensions ▶ pp. 39 to 43 Driver Dimensions ▶ p. 45

If allowable torque is exceeded when using a motor with low-backlash gears, the gears may be damaged. When selecting a motor, ensure that its allowable torque will not be exceeded. Data is measured under the trial conditions of SANYO DENKI. Driving torque may vary according to actual machine precision.

Size	Motor size	60 mm sq.					
	Motor + gear length	94.8 mm					
Single shaft	Set model number	<b>FA512M601S-CX3.6</b>	<b>FA512M601S-CX7.2</b>	<b>FA512M601S-CX10</b>	<b>FA512M601S-CX20</b>	<b>FA512M601S-CX30</b>	<b>FA512M601S-CX36</b>
	Configuration item: motor model number	SM5601-72CXA40	SM5601-72CXB40	SM5601-72CXE40	SM5601-72CXG40	SM5601-72CXJ40	SM5601-72CXK40
	Configuration item: driver model number	F5PAA075P100	F5PAA075P100	F5PAA075P100	F5PAA075P100	F5PAA075P100	F5PAA075P100
Dual shaft	Set model number	<b>FA512M601D-CX3.6</b>	<b>FA512M601D-CX7.2</b>	<b>FA512M601D-CX10</b>	<b>FA512M601D-CX20</b>	<b>FA512M601D-CX30</b>	<b>FA512M601D-CX36</b>
	Configuration item: motor model number	SM5601-72CXA10	SM5601-72CXB10	SM5601-72CXE10	SM5601-72CXG10	SM5601-72CXJ10	SM5601-72CXK10
	Configuration item: driver model number	F5PAA075P100	F5PAA075P100	F5PAA075P100	F5PAA075P100	F5PAA075P100	F5PAA075P100
Allowable torque	N·m	1.25	2.5	3	3.5	4	4
Rotor inertia	×10 <sup>-4</sup> kg·m <sup>2</sup>	0.2	0.2	0.2	0.2	0.2	0.2
Rated current	A/phase	0.75	0.75	0.75	0.75	0.75	0.75
Basic step angle	°	0.2	0.1	0.072	0.036	0.024	0.02
Gear ratio	—	1:3.6	1:7.2	1:10	1:20	1:30	1:36
Backlash	° or less	0.55	0.25	0.25	0.17	0.17	0.17
Allowable speed	min <sup>-1</sup>	500	250	180	90	60	50
Motor mass *1	kg	1	1	1	1	1	1
Allowable thrust load	N	30	30	30	30	30	30
Allowable radial load *2	N	100	100	100	100	100	100

Note: Directions of motor rotation and gear output shaft rotation are the same for models with reduction ratios 1:3.6 and 1:7.2, and opposite for reduction ratios 1:10, 1:20, 1:30 and 1:36.

\*1 Driver mass ▶ p. 45

\*2 When load is applied at 1/3 length from output shaft edge.

### Characteristics diagram

Winding current: 0.75A/phase

Allowable torque ———  
fs: Maximum self-start frequency when not loaded ●

Source current (no load) - - - - -

Source current (load applied) ······

#### FA512M601S-CX3.6 FA512M601D-CX3.6

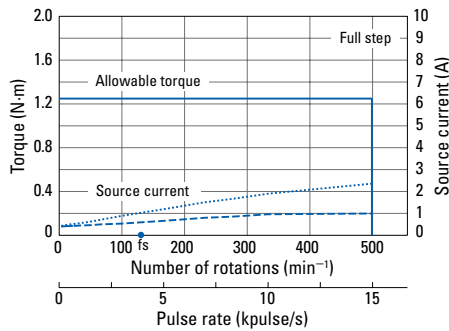

#### FA512M601S-CX7.2 FA512M601D-CX7.2

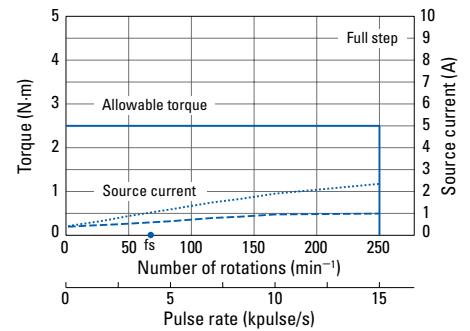

#### FA512M601S-CX10 FA512M601D-CX10

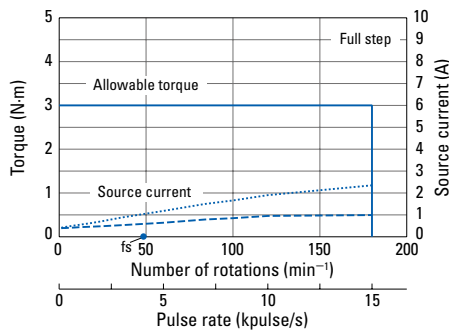

#### FA512M601S-CX20 FA512M601D-CX20

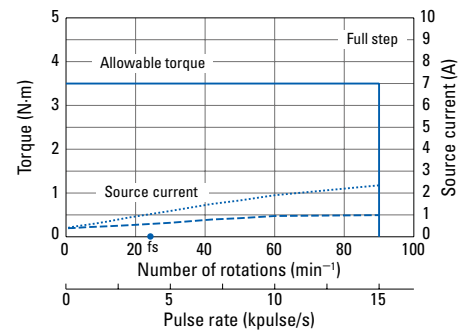

#### FA512M601S-CX30 FA512M601D-CX30

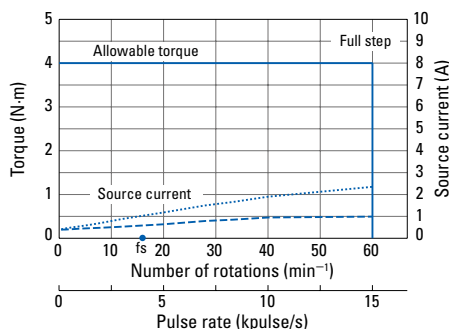

#### FA512M601S-CX36 FA512M601D-CX36

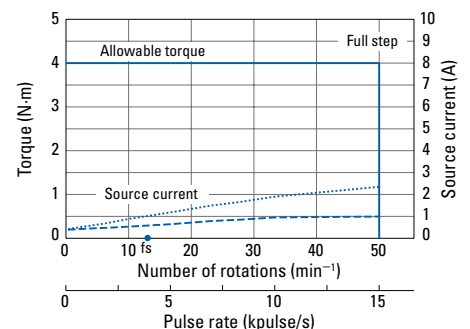

System Configuration Diagram ▶ p. 12 Set Model Configuration ▶ pp. 14 to 15 Motor Dimensions ▶ pp. 39 to 43 Driver Dimensions ▶ p. 45

If allowable torque is exceeded when using a motor with low-backlash gears, the gears may be damaged. When selecting a motor, ensure that its allowable torque will not be exceeded. Data is measured under the trial conditions of SANYO DENKI. Driving torque may vary according to actual machine precision.

Size	Motor size	86 mm sq. (angular dimension 90 mm sq.)					
	Motor + gear length	131 mm					
Single shaft	Set model number	<b>FA512M861S-CX3.6</b>	<b>FA512M861S-CX7.2</b>	<b>FA512M861S-CX10</b>	<b>FA512M861S-CX20</b>	<b>FA512M861S-CX30</b>	<b>FA512M861S-CX36</b>
	Configuration item: motor model number	SM5861-72CXA40	SM5861-72CXB40	SM5861-72CXE40	SM5861-72CXG40	SM5861-72CXJ40	SM5861-72CXK40
	Configuration item: driver model number	F5PAA075P100	F5PAA075P100	F5PAA075P100	F5PAA075P100	F5PAA075P100	F5PAA075P100
Dual shaft	Set model number	<b>FA512M861D-CX3.6</b>	<b>FA512M861D-CX7.2</b>	<b>FA512M861D-CX10</b>	<b>FA512M861D-CX20</b>	<b>FA512M861D-CX30</b>	<b>FA512M861D-CX36</b>
	Configuration item: motor model number	SM5861-72CXA10	SM5861-72CXB10	SM5861-72CXE10	SM5861-72CXG10	SM5861-72CXJ10	SM5861-72CXK10
	Configuration item: driver model number	F5PAA075P100	F5PAA075P100	F5PAA075P100	F5PAA075P100	F5PAA075P100	F5PAA075P100
Allowable torque	N·m	4.5	9	9	12	12	12
Rotor inertia	×10 <sup>-4</sup> kg·m <sup>2</sup>	1.48	1.48	1.48	1.48	1.48	1.48
Rated current	A/phase	0.75	0.75	0.75	0.75	0.75	0.75
Basic step angle	°	0.2	0.1	0.072	0.036	0.024	0.02
Gear ratio	—	1:3.6	1:7.2	1:10	1:20	1:30	1:36
Backlash	° or less	0.35	0.22	0.22	0.15	0.15	0.15
Allowable speed	min <sup>-1</sup>	500	250	180	90	60	50
Motor mass *1	kg	2.95	2.95	2.95	2.95	2.95	2.95
Allowable thrust load	N	60	60	60	60	60	60
Allowable radial load *2	N	300	300	300	300	300	300

Note: Directions of motor rotation and gear output shaft rotation are the same for models with reduction ratios 1:3.6 and 1:7.2, and opposite for reduction ratios 1:10, 1:20, 1:30 and 1:36.  
 \*1 Driver mass ▶ p. 45  
 \*2 When load is applied at 1/3 length from output shaft edge.

**Characteristics diagram**

Winding current: 0.75A/phase

Allowable torque ——— Source current (no load) - - - - - Source current (load applied) ······  
 fs: Maximum self-start frequency when not loaded ●

**FA512M861S-CX3.6**  
**FA512M861D-CX3.6**

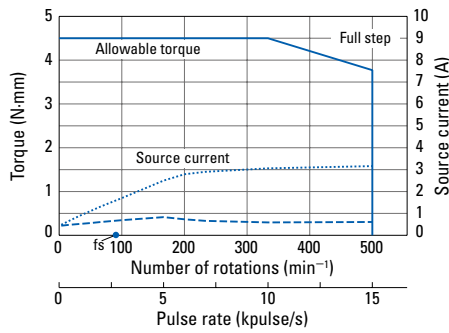

**FA512M861S-CX7.2**  
**FA512M861D-CX7.2**

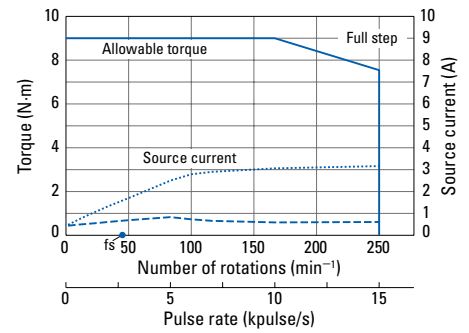

**FA512M861S-CX10**  
**FA512M861D-CX10**

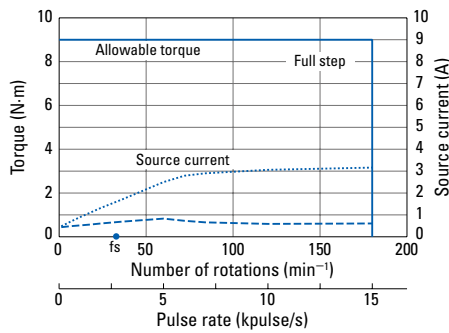

**FA512M861S-CX20**  
**FA512M861D-CX20**

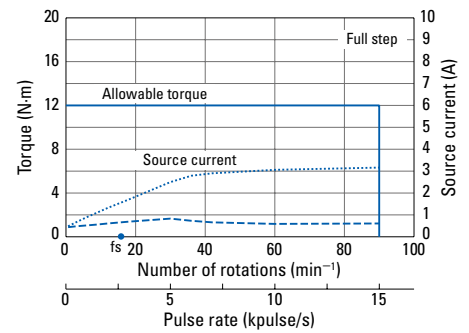

**FA512M861S-CX30**  
**FA512M861D-CX30**

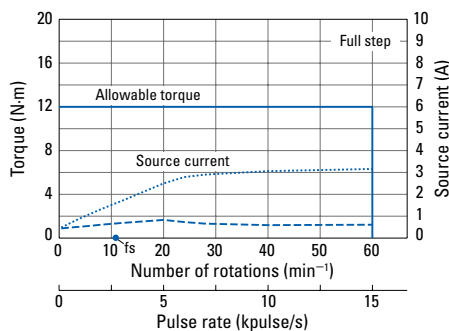

**FA512M861S-CX36**  
**FA512M861D-CX36**

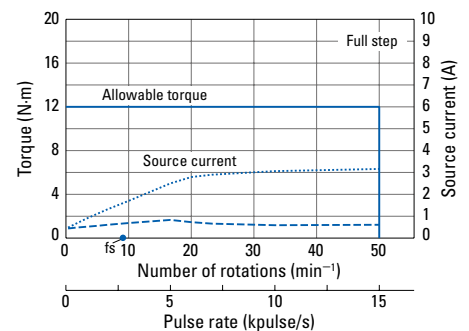

Size	Motor size	42 mm sq.			60 mm sq.	
	Motor + gear length	74.4 mm			116.3 mm	
Single shaft	Set model number	<b>FA511M421S-HX30</b>	<b>FA511M421S-HX50</b>	<b>FA511M421S-HX100</b>	<b>FA512M601S-HX50</b>	<b>FA512M601S-HX100</b>
	Configuration item: motor model number	SM5421-32HXJ40	SM5421-32HXL40	SM5421-32HXM40	SM5601-72HXL40	SM5601-72HXM40
	Configuration item: driver model number	F5PAA035P100	F5PAA035P100	F5PAA035P100	F5PAA075P100	F5PAA075P100
Dual shaft	Set model number	<b>FA511M421D-HX30</b>	<b>FA511M421D-HX50</b>	<b>FA511M421D-HX100</b>	<b>FA512M601D-HX50</b>	<b>FA512M601D-HX100</b>
	Configuration item: motor model number	SM5421-32HXJ10	SM5421-32HXL10	SM5421-32HXM10	SM5601-72HXL10	SM5601-72HXM10
	Configuration item: driver model number	F5PAA035P100	F5PAA035P100	F5PAA035P100	F5PAA075P100	F5PAA075P100
Allowable torque	N·m	2.2	3.5	5	5.5	8
Momentary allowable torque	N·m	4.5	8.3	11	14	20
Rotor inertia	×10 <sup>-4</sup> kg·m <sup>2</sup>	0.04	0.04	0.04	0.23	0.23
Rated current	A/phase	0.35	0.35	0.35	0.75	0.75
Basic step angle	°	0.024	0.0144	0.0072	0.0144	0.0072
Gear ratio	—	1:30	1:50	1:100	1:50	1:100
Hysteresis loss	Arc min or less	3.6	2.4	2.4	—	—
Lost motion	Arc min	—	—	—	0.4 to 3 (±0.28 N·m)	0.4 to 1.5 (±0.4 N·m)
Allowable speed	min <sup>-1</sup>	116	70	35	70	35
Motor mass *1	kg	0.44	0.44	0.44	1.22	1.22
Allowable thrust load	N	1150	1150	1150	400	400
Allowable radial load *2	N	275	275	275	360	360

Note: The motor and gear output shaft rotate in the opposite direction.

\*1 Driver mass ▶ p. 45

\*2 When load is applied at 1/3 length from output shaft edge.

### Characteristics diagram

Momentary allowable torque --- Source current (no load) --- fs: Maximum self-start frequency when not loaded ●  
 Allowable torque — Source current (load applied) ·····

#### FA511M421S-HX30 FA511M421D-HX30

Winding current:  
0.35 A/phase

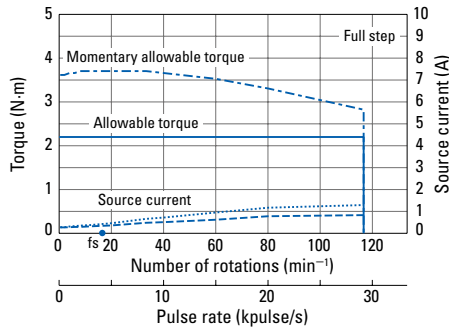

#### FA511M421S-HX50 FA511M421D-HX50

Winding current:  
0.35 A/phase

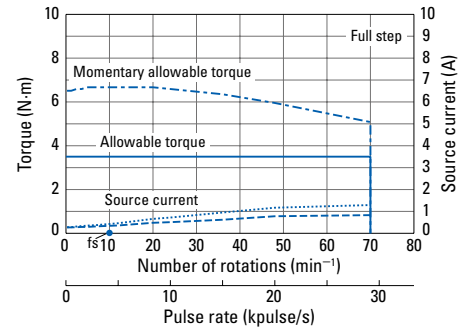

#### FA511M421S-HX100 FA511M421D-HX100

Winding current:  
0.35 A/phase

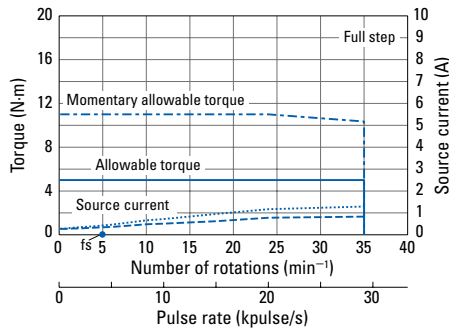

#### FA512M601S-HX50 FA512M601D-HX50

Winding current:  
0.75 A/phase

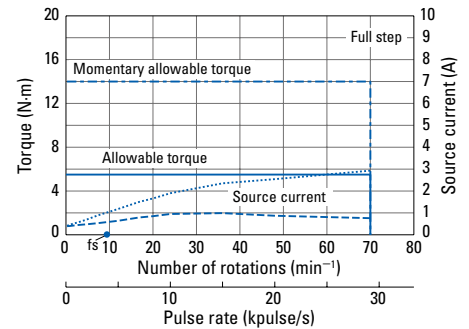

#### FA512M601S-HX100 FA512M601D-HX100

Winding current:  
0.75 A/phase

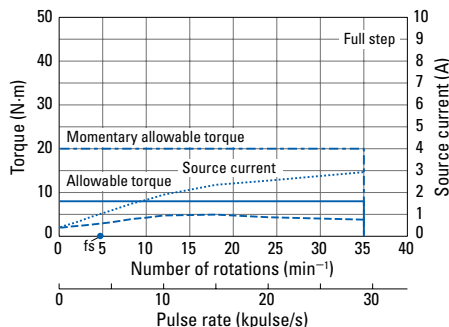

System Configuration Diagram ▶ p. 12 Set Model Configuration ▶ pp. 14 to 15 Motor Dimensions ▶ pp. 39 to 43 Driver Dimensions ▶ p. 45

If allowable instantaneous torque is exceeded when using a motor with harmonic gears, the gears may be damaged. When selecting a motor, ensure that its allowable instantaneous torque will not be exceeded. Data is measured under the trial conditions of SANYO DENKI. Driving torque may vary according to actual machine precision.

Size	Motor size	86 mm sq. (angular dimension 90 mm sq.)	
	Motor + gear length	148 mm	
Single shaft	Set model number	FA512M861S-HX50	FA512M861S-HX100
	Configuration item: motor model number	SM5861-72HXL40	SM5861-72HXM40
	Configuration item: driver model number	F5PAA075P100	
Dual shaft	Set model number	FA512M861D-HX50	FA512M861D-HX100
	Configuration item: motor model number	SM5861-72HXL10	SM5861-72HXM10
	Configuration item: driver model number	F5PAA075P100	
Allowable torque	N·m	25	40
Momentary allowable torque	N·m	34	59
Rotor inertia	$\times 10^{-4}$ kg·m <sup>2</sup>	1.68	1.68
Rated current	A/phase	0.75	0.75
Basic step angle	°	0.0144	0.0072
Gear ratio	—	1:50	1:100
Hysteresis loss	Arc min or less	—	—
Lost motion	Arc min	0.4 to 3 ( $\pm 1$ N·m)	0.4 to 3 ( $\pm 1.2$ N·m)
Allowable speed	min <sup>-1</sup>	70	35
Motor mass *1	kg	3.6	3.6
Allowable thrust load	N	1400	1400
Allowable radial load *2	N	1600	1600

Note: The motor and gear output shaft rotate in the opposite direction.  
 \*1 Driver mass ▶ p. 45  
 \*2 When load is applied at 1/3 length from output shaft edge.

Characteristics diagram

Winding current: 0.75A/phase

Momentary allowable torque -----  
 Allowable torque ————

Source current (no load) ----- fs: Maximum self-start frequency when not loaded ●  
 Source current (load applied) .....

FA512M861S-HX50  
 FA512M861D-HX50

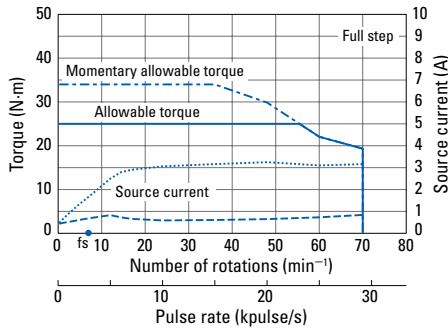

FA512M861S-HX100  
 FA512M861D-HX100

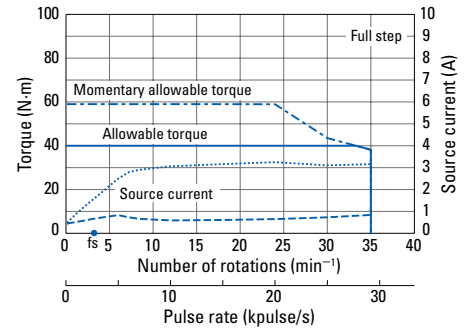

Basic step angle: 0.72°

Size	Motor size	42 mm sq.			60 mm sq.			
		68 mm	74.3 mm	82 mm	91.4 mm	102.6 mm	131.3 mm	
Single shaft	Motor + brake length							
	Set model number	<b>FA511M421S-XB</b>	<b>FA511M422S-XB</b>	<b>FA511M423S-XB</b>	<b>FA512M601S-XB</b>	<b>FA512M602S-XB</b>	<b>FA512M603S-XB</b>	
	Configuration item: motor model number	SM5421-32XB40	SM5422-32XB40	SM5423-32XB40	SM5601-72XB40	SM5602-72XB40	SM5603-72XB40	
	Configuration item: driver model number	F5PAA035P100	F5PAA035P100	F5PAA035P100	F5PAA075P100	F5PAA075P100	F5PAA075P100	
	Holding torque	N·m min.	0.13	0.185	0.245	0.57	0.9	1.7
	Rotor inertia	×10 <sup>-4</sup> kg·m <sup>2</sup>	0.043	0.06	0.071	0.36	0.47	0.76
	Rated current	A/phase	0.35	0.35	0.35	0.75	0.75	0.75
	Motor mass *1	kg	0.39	0.46	0.53	0.96	1.14	1.61
	Allowable thrust load	N	10	10	10	20	20	20
	Allowable radial load *2	N	56	54	52	191	183	170
Electromagnetic brake	Brake type	—	No excitation actuating type	No excitation actuating type	No excitation actuating type	No excitation actuating type	No excitation actuating type	No excitation actuating type
	Power supply input	V	24±5%	24±5%	24±5%	24±5%	24±5%	24±5%
	Power consumption	W	2.4 (75°C)	2.4 (75°C)	2.4 (75°C)	6 (75°C)	6 (75°C)	6 (75°C)
	Static friction torque	N·m min.	0.3	0.3	0.3	0.8	0.8	0.8
	Brake operating time	ms max.	20	20	20	20	20	20
	Brake release time	ms max.	30	30	30	30	30	30

\*1 Driver mass ▶ p. 45

\*2 The load point is at the tip of the output shaft.

### Characteristics diagram

With rubber coupling

Pull-out torque —  
fs: Maximum self-start frequency when not loaded ●

Source current (no load) - - - - -

Source current (load applied) ······

#### FA511M421S-XB

Winding current:  
0.35 A/phase

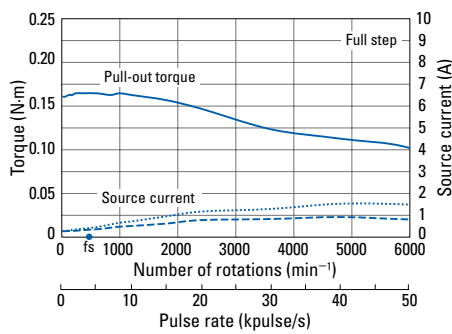

#### FA511M422S-XB

Winding current:  
0.35 A/phase

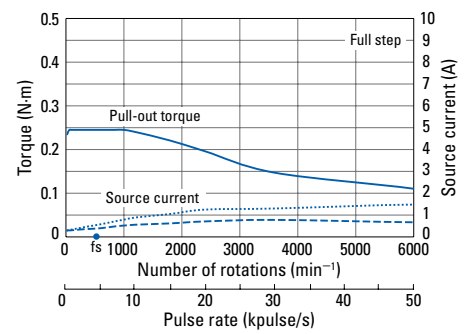

#### FA511M423S-XB

Winding current:  
0.35 A/phase

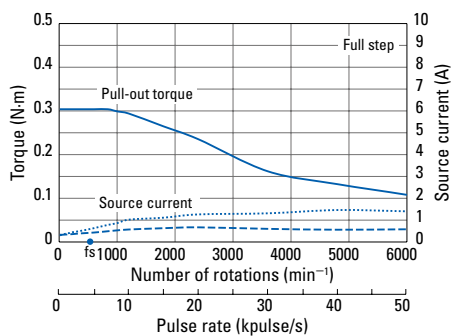

#### FA512M601S-XB

Winding current:  
0.75 A/phase

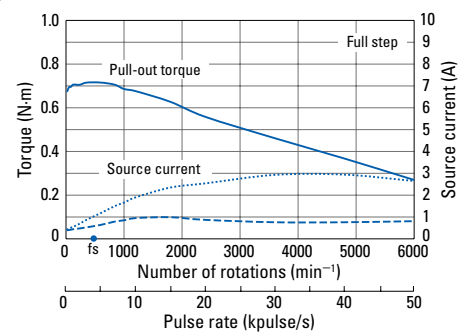

#### FA512M602S-XB

Winding current:  
0.75 A/phase

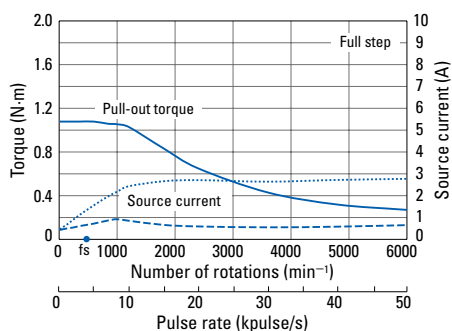

#### FA512M603S-XB

Winding current:  
0.75 A/phase

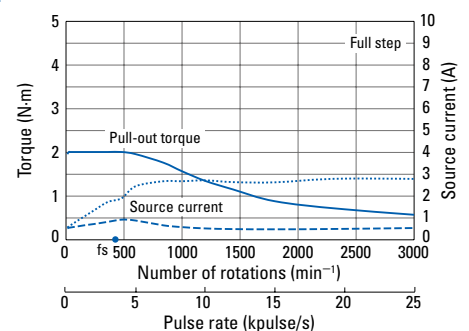

System Configuration Diagram ▶ p. 12 Set Model Configuration ▶ pp. 14 to 15 Motor Dimensions ▶ pp. 39 to 43 Driver Dimensions ▶ p. 45

The electromagnetic brake only works when the motor is stopped, and cannot be used for braking.

Data is measured under the trial conditions of SANYO DENKI. Driving torque may vary according to actual machine precision.



Basic step angle: 0.72°

Size	Motor size	86 mm sq.			
	Motor + brake length	119.5 mm	150 mm	180.4 mm	
Single shaft	Set model number	FA512M861S-XB	FA512M862S-XB	FA512M863S-XB	
	Configuration item: motor model number	SM5861-72XB40	SM5862-72XB40	SM5863-72XB40	
	Configuration item: driver model number	F5PAA075P100	F5PAA075P100	F5PAA075P100	
Holding torque	N·m min.	2.3	4.4	6.8	
Rotor inertia	×10 <sup>-4</sup> kg·m <sup>2</sup>	2.55	4.07	5.57	
Rated current	A/phase	0.75	0.75	0.75	
Motor mass *1	kg	2.6	3.75	4.85	
Allowable thrust load	N	60	60	60	
Allowable radial load *2	N	200	200	200	
Electromagnetic brake	Brake type	—	No excitation actuating type	No excitation actuating type	No excitation actuating type
	Power supply input	V	24±10%	24±10%	24±10%
	Power consumption	W	10.5 (20°C)	10.5 (20°C)	10.5 (20°C)
	Static friction torque	N·m min.	5	5	5
	Brake operating time	ms max.	20	20	20
Brake release time	ms max.	50	50	50	

\*1 Driver mass ▶ p. 45

\*2 The load point is at the tip of the output shaft.

### Characteristics diagram

Winding current: 0.75A/phase  
With rubber coupling

Pull-out torque ———  
fs: Maximum self-start frequency when not loaded ●

Source current (no load) - - - - -

Source current (load applied) ······

#### FA512M861S-XB

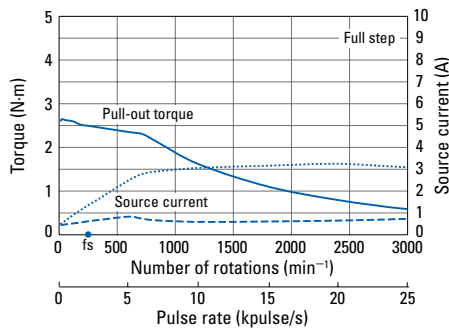

#### FA512M862S-XB

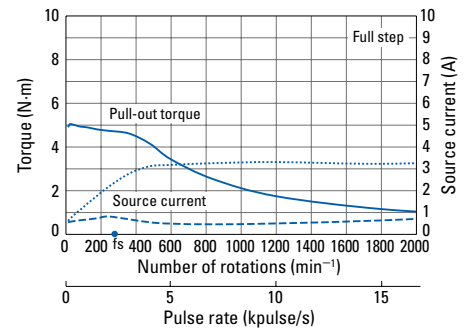

#### FA512M863S-XB

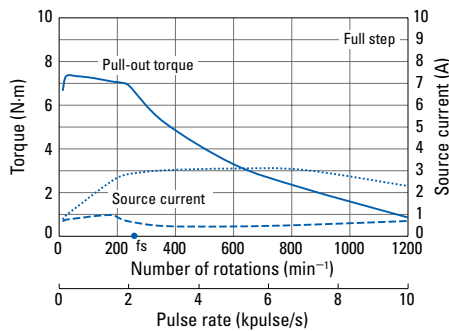

Basic step angle: 0.72°

Size	Motor size	42 mm sq.			60 mm sq.		
	Motor + encoder length	51.3 mm	57.6 mm	65.3 mm	65.6 mm	76.8 mm	105.5 mm
Single shaft	Set model number	FA511M421S-XE	FA511M422S-XE	FA511M423S-XE	FA512M601S-XE	FA512M602S-XE	FA512M603S-XE
	Configuration item: motor model number	SM5421-32XE40	SM5422-32XE40	SM5423-32XE40	SM5601-72XE40	SM5602-72XE40	SM5603-72XE40
	Configuration item: driver model number	F5PAA035P100	F5PAA035P100	F5PAA035P100	F5PAA075P100	F5PAA075P100	F5PAA075P100
Holding torque	N·m min.	0.13	0.185	0.245	0.57	0.9	1.7
Rotor inertia	×10 <sup>-4</sup> kg·m <sup>2</sup>	0.028	0.045	0.056	0.2	0.31	0.6
Rated current	A/phase	0.35	0.35	0.35	0.75	0.75	0.75
Motor mass *1	kg	0.33	0.4	0.47	0.68	0.86	1.33
Allowable thrust load	N	10	10	10	20	20	20
Allowable radial load *2	N	56	54	52	191	183	170
Encoder	Resolution	P/R	4000	4000	4000	4000	4000
	Number of channels	CH	3	3	3	3	3
	Output method	—	Line driver (C-MOS)	Line driver (C-MOS)	Line driver (C-MOS)	Line driver (C-MOS)	Line driver (C-MOS)
	Max. response frequency	kHz	220	220	220	220	220
	Power supply input	V	5±5%	5±5%	5±5%	5±5%	5±5%
	Current consumption	mA max.	100	100	100	100	100

\*1 Driver mass ▶ p. 45

\*2 The load point is at the tip of the output shaft.

### Characteristics diagram

With rubber coupling

Pull-out torque ———  
fs: Maximum self-start frequency when not loaded ●

Source current (no load) - - - - -

Source current (load applied) ······

#### FA511M421S-XE

Winding current:  
0.35 A/phase

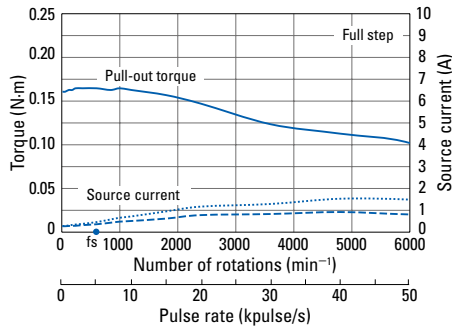

#### FA511M422S-XE

Winding current:  
0.35 A/phase

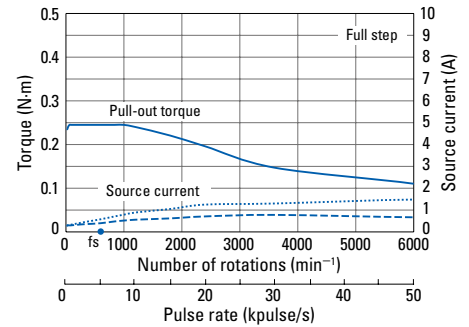

#### FA511M423S-XE

Winding current:  
0.35 A/phase

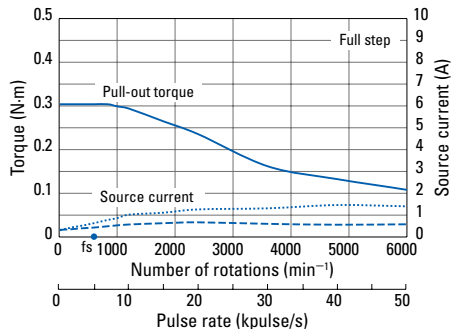

#### FA512M601S-XE

Winding current:  
0.75 A/phase

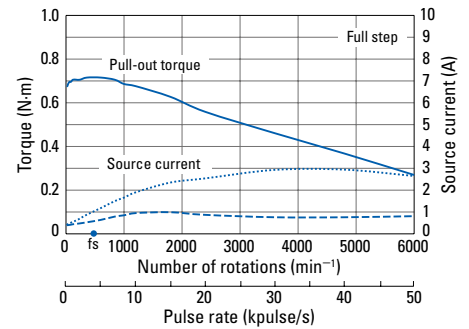

#### FA512M602S-XE

Winding current:  
0.75 A/phase

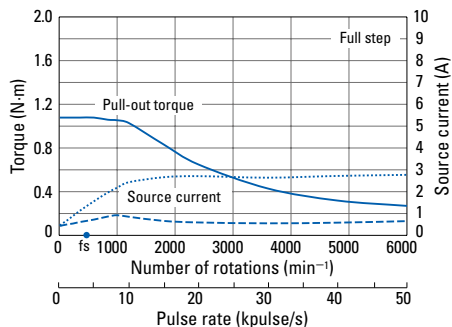

#### FA512M603S-XE

Winding current:  
0.75 A/phase

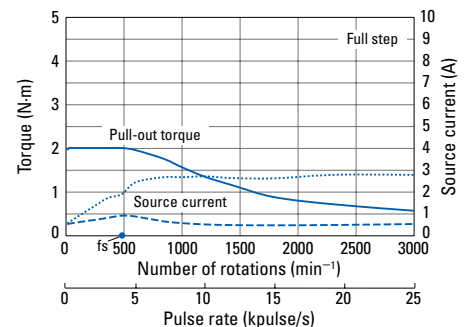

Basic step angle: 0.72°

Size	Motor size	86 mm sq.			
	Motor + encoder length	79.5 mm	110 mm	140.5 mm	
Single shaft	Set model number	FA512M861S-XE	FA512M862S-XE	FA512M863S-XE	
	Configuration item: motor model number	SM5861-72XE40	SM5862-72XE40	SM5863-72XE40	
	Configuration item: driver model number	F5PAA075P100	F5PAA075P100	F5PAA075P100	
Holding torque	N·m min.	2.3	4.4	6.8	
Rotor inertia	×10 <sup>-4</sup> kg·m <sup>2</sup>	1.48	3	4.5	
Rated current	A/phase	0.75	0.75	0.75	
Motor mass *1	kg	1.8	3	4.1	
Allowable thrust load	N	60	60	60	
Allowable radial load *2	N	200	200	200	
Encoder	Resolution	P/R	4000	4000	4000
	Number of channels	CH	3	3	3
	Output method	—	Line driver (C-MOS)	Line driver (C-MOS)	Line driver (C-MOS)
	Max. response frequency	kHz	220	220	220
	Power supply input	V	5±5%	5±5%	5±5%
	Current consumption	mA max.	100	100	100

\*1 Driver mass ▶ p. 45

\*2 The load point is at the tip of the output shaft.

### Characteristics diagram

Winding current: 0.75A/phase  
With rubber coupling

Pull-out torque ——— Source current (no load) - - - - -  
fs: Maximum self-start frequency when not loaded ●

Source current (load applied) ······

#### FA512M861S-XE

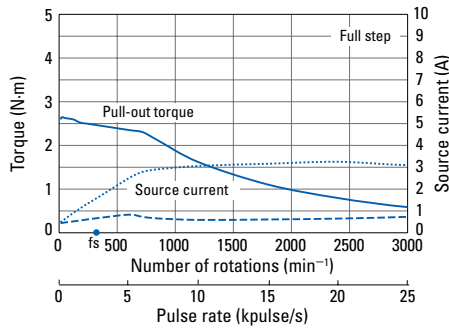

#### FA512M862S-XE

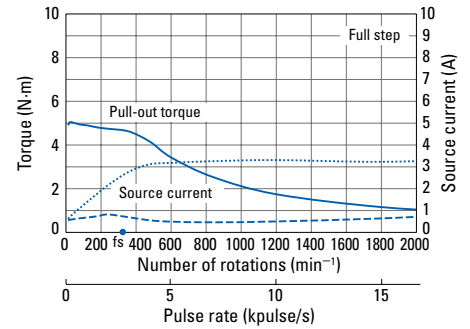

#### FA512M863S-XE

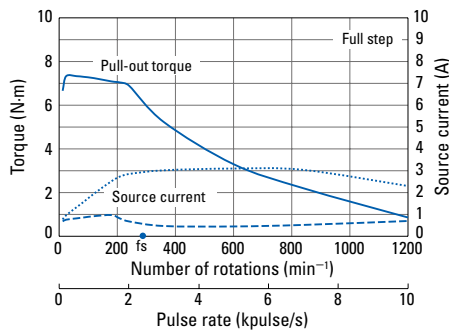

Basic step angle: 0.72°

Size	Motor size	42 mm sq.			60 mm sq.		
		35 mm	41 mm	49 mm	49 mm	60 mm	89 mm
Single shaft	Motor length						
	Set model number	<b>FB511M421S</b>	<b>FB511M422S</b>	<b>FB511M423S</b>	<b>FB512M601S</b>	<b>FB512M602S</b>	<b>FB512M603S</b>
	Configuration item: motor model number	SM5421-3240	SM5422-3240	SM5423-3240	SM5601-7240	SM5602-7240	SM5603-7240
Dual shaft	Configuration item: driver model number	F5PAB035P100	F5PAB035P100	F5PAB035P100	F5PAB075P100	F5PAB075P100	F5PAB075P100
	Set model number	<b>FB511M421D</b>	<b>FB511M422D</b>	<b>FB511M423D</b>	<b>FB512M601D</b>	<b>FB512M602D</b>	<b>FB512M603D</b>
	Configuration item: motor model number	SM5421-3210	SM5422-3210	SM5423-3210	SM5601-7210	SM5602-7210	SM5603-7210
Configuration item: driver model number	F5PAB035P100	F5PAB035P100	F5PAB035P100	F5PAB075P100	F5PAB075P100	F5PAB075P100	
Holding torque	N·m min.	0.13	0.185	0.245	0.57	0.9	1.7
Rotor inertia	×10 <sup>-4</sup> ·kg·m <sup>2</sup>	0.028	0.045	0.056	0.2	0.31	0.6
Rated current	A/phase	0.35	0.35	0.35	0.75	0.75	0.75
Motor mass *1	kg	0.24	0.31	0.38	0.62	0.8	1.27
Allowable thrust load	N	10	10	10	20	20	20
Allowable radial load *2	N	56	54	52	191	183	170

\*1 Driver mass ▶ p. 45

\*2 The load point is at the tip of the output shaft.

## Characteristics diagram

With rubber coupling

Pull-out torque ———  
fs: Maximum self-start frequency when not loaded ●

Source current (no load) - - - - -

Source current (load applied) ······

### FB511M421S FB511M421D

Winding current:  
0.35 A/phase

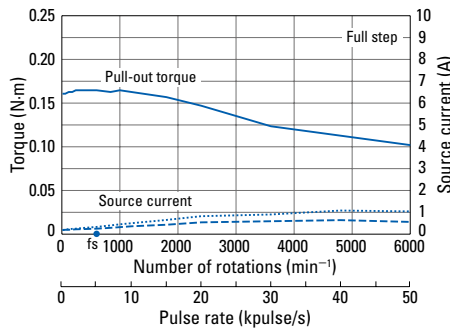

### FB511M422S FB511M422D

Winding current:  
0.35 A/phase

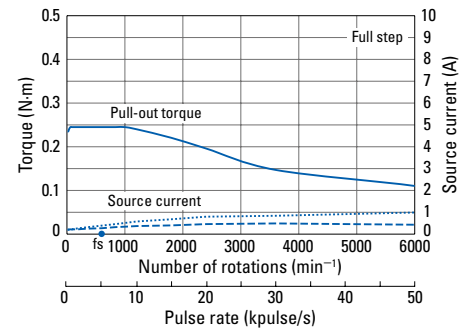

### FB511M423S FB511M423D

Winding current:  
0.35 A/phase

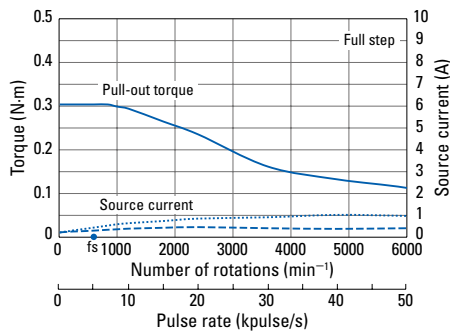

### FB512M601S FB512M601D

Winding current:  
0.75 A/phase

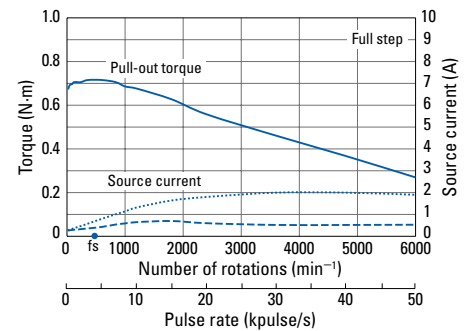

### FB512M602S FB512M602D

Winding current:  
0.75 A/phase

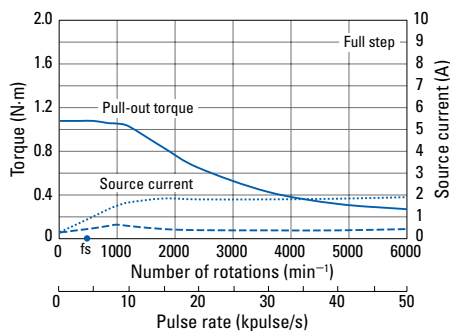

### FB512M603S FB512M603D

Winding current:  
0.75 A/phase

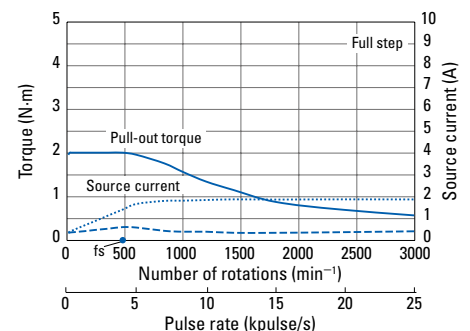

Basic step angle: 0.72°

Size	Motor size	86 mm sq.		
		66 mm	96.5 mm	127 mm
Single shaft	Motor length			
	Set model number	<b>FB512M861S</b>	<b>FB512M862S</b>	<b>FB512M863S</b>
	Configuration item: motor model number	SM5861-7240	SM5862-7240	SM5863-7240
Dual shaft	Configuration item: driver model number	F5PAB075P100	F5PAB075P100	F5PAB075P100
	Set model number	<b>FB512M861D</b>	<b>FB512M862D</b>	<b>FB512M863D</b>
	Configuration item: motor model number	SM5861-7210	SM5862-7210	SM5863-7210
	Configuration item: driver model number	F5PAB075P100	F5PAB075P100	F5PAB075P100
Holding torque	N·m min.	2.3	4.4	6.8
Rotor inertia	×10 <sup>-4</sup> kg·m <sup>2</sup>	1.48	3	4.5
Rated current	A/phase	0.75	0.75	0.75
Motor mass *1	kg	1.75	2.9	4
Allowable thrust load	N	60	60	60
Allowable radial load *2	N	200	200	200

\*1 Driver mass ▶ p. 45

\*2 The load point is at the tip of the output shaft.

### Characteristics diagram

Winding current: 0.75A/phase  
With rubber coupling

Pull-out torque ———  
fs: Maximum self-start frequency when not loaded ●

Source current (no load) - - - - -

Source current (load applied) ······

**FB512M861S**  
**FB512M861D**

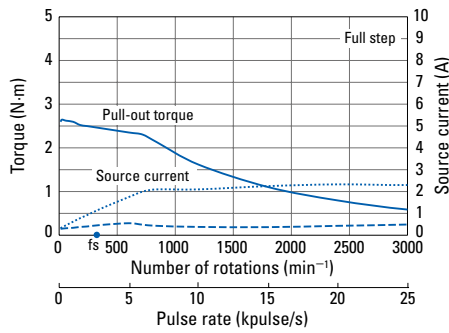

**FB512M862S**  
**FB512M862D**

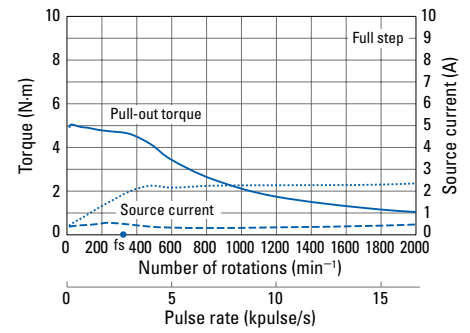

**FB512M863S**  
**FB512M863D**

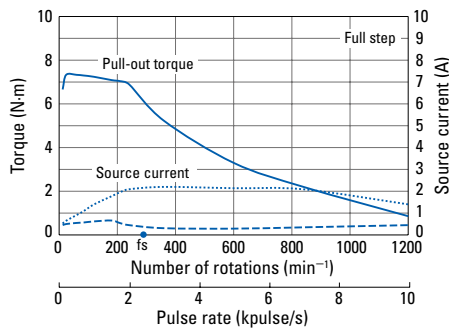

Size	Motor size	42 mm sq.					
	Motor + gear length	65.4 mm					
Single shaft	Set model number	<b>FB511M421S-CX3.6</b>	<b>FB511M421S-CX7.2</b>	<b>FB511M421S-CX10</b>	<b>FB511M421S-CX20</b>	<b>FB511M421S-CX30</b>	<b>FB511M421S-CX36</b>
	Configuration item: motor model number	SM5421-32CXA40	SM5421-32CXB40	SM5421-32CXE40	SM5421-32CXG40	SM5421-32CXJ40	SM5421-32CXK40
	Configuration item: driver model number	F5PAB035P100	F5PAB035P100	F5PAB035P100	F5PAB035P100	F5PAB035P100	F5PAB035P100
Dual shaft	Set model number	<b>FB511M421D-CX3.6</b>	<b>FB511M421D-CX7.2</b>	<b>FB511M421D-CX10</b>	<b>FB511M421D-CX20</b>	<b>FB511M421D-CX30</b>	<b>FB511M421D-CX36</b>
	Configuration item: motor model number	SM5421-32CXA10	SM5421-32CXB10	SM5421-32CXE10	SM5421-32CXG10	SM5421-32CXJ10	SM5421-32CXK10
	Configuration item: driver model number	F5PAB035P100	F5PAB035P100	F5PAB035P100	F5PAB035P100	F5PAB035P100	F5PAB035P100
Allowable torque	N·m	0.343	0.686	1	1.5	1.5	1.5
Rotor inertia	×10 <sup>-4</sup> kg·m <sup>2</sup>	0.028	0.028	0.028	0.028	0.028	0.028
Rated current	A/phase	0.35	0.35	0.35	0.35	0.35	0.35
Basic step angle	°	0.2	0.1	0.072	0.036	0.024	0.02
Gear ratio	—	1:3.6	1:7.2	1:10	1:20	1:30	1:36
Backlash	° or less	0.6	0.4	0.35	0.25	0.25	0.25
Allowable speed	min <sup>-1</sup>	500	250	180	90	60	50
Motor mass *1	kg	0.37	0.37	0.37	0.37	0.37	0.37
Allowable thrust load	N	15	15	15	15	15	15
Allowable radial load *2	N	20	20	20	20	20	20

Note: Directions of motor rotation and gear output shaft rotation are the same for models with reduction ratios 1:3.6, 1:7.2 and 1:10, and opposite for reduction ratios 1:20, 1:30, and 1:36.

\*1 Driver mass ▶ p. 45

\*2 When load is applied at 1/3 length from output shaft edge.

### Characteristics diagram

Winding current: 0.35A/phase

Allowable torque ———  
fs: Maximum self-start frequency when not loaded ●

Source current (no load) - - - - -

Source current (load applied) ······

**FB511M421S-CX3.6**  
**FB511M421D-CX3.6**

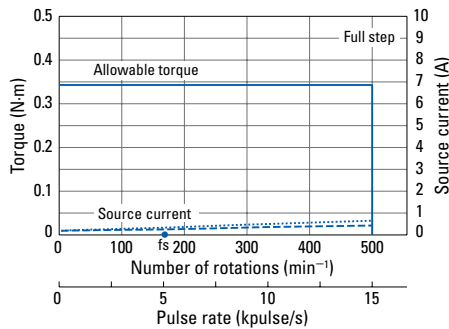

**FB511M421S-CX7.2**  
**FB511M421D-CX7.2**

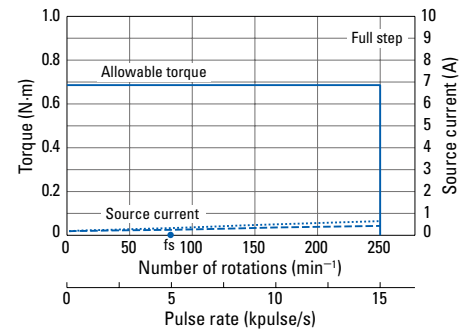

**FB511M421S-CX10**  
**FB511M421D-CX10**

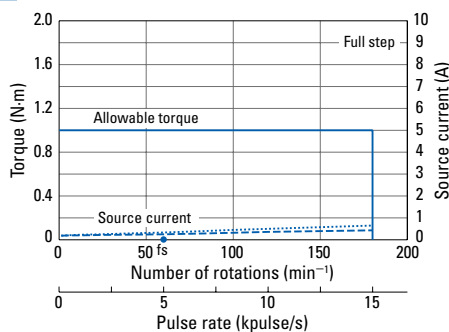

**FB511M421S-CX20**  
**FB511M421D-CX20**

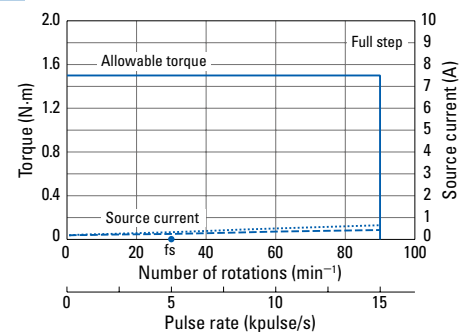

**FB511M421S-CX30**  
**FB511M421D-CX30**

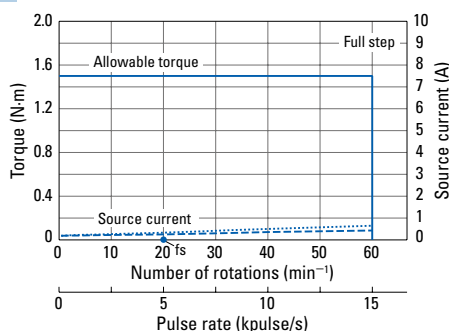

**FB511M421S-CX36**  
**FB511M421D-CX36**

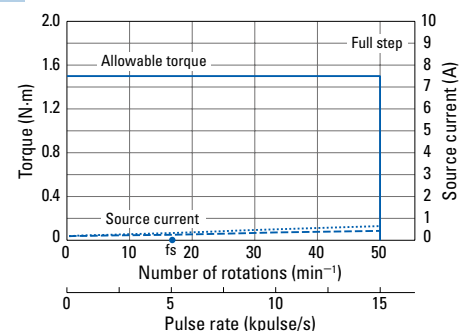

System Configuration Diagram ▶ p. 12 Set Model Configuration ▶ pp. 14 to 15 Motor Dimensions ▶ pp. 39 to 43 Driver Dimensions ▶ p. 45

If allowable torque is exceeded when using a motor with low-backlash gears, the gears may be damaged. When selecting a motor, ensure that its allowable torque will not be exceeded. Data is measured under the trial conditions of SANYO DENKI. Driving torque may vary according to actual machine precision.

Size	Motor size	60 mm sq.					
	Motor + gear length	94.8 mm					
Single shaft	Set model number	<b>FB512M601S-CX3.6</b>	<b>FB512M601S-CX7.2</b>	<b>FB512M601S-CX10</b>	<b>FB512M601S-CX20</b>	<b>FB512M601S-CX30</b>	<b>FB512M601S-CX36</b>
	Configuration item: motor model number	SM5601-72CXA40	SM5601-72CXB40	SM5601-72CXE40	SM5601-72CXG40	SM5601-72CXJ40	SM5601-72CXK40
	Configuration item: driver model number	F5PAB075P100	F5PAB075P100	F5PAB075P100	F5PAB075P100	F5PAB075P100	F5PAB075P100
Dual shaft	Set model number	<b>FB512M601D-CX3.6</b>	<b>FB512M601D-CX7.2</b>	<b>FB512M601D-CX10</b>	<b>FB512M601D-CX20</b>	<b>FB512M601D-CX30</b>	<b>FB512M601D-CX36</b>
	Configuration item: motor model number	SM5601-72CXA10	SM5601-72CXB10	SM5601-72CXE10	SM5601-72CXG10	SM5601-72CXJ10	SM5601-72CXK10
	Configuration item: driver model number	F5PAB075P100	F5PAB075P100	F5PAB075P100	F5PAB075P100	F5PAB075P100	F5PAB075P100
Allowable torque	N·m	1.25	2.5	3	3.5	4	4
Rotor inertia	×10 <sup>-4</sup> kg·m <sup>2</sup>	0.2	0.2	0.2	0.2	0.2	0.2
Rated current	A/phase	0.75	0.75	0.75	0.75	0.75	0.75
Basic step angle	°	0.2	0.1	0.072	0.036	0.024	0.02
Gear ratio	—	1:3.6	1:7.2	1:10	1:20	1:30	1:36
Backlash	° or less	0.55	0.25	0.25	0.17	0.17	0.17
Allowable speed	min <sup>-1</sup>	500	250	180	90	60	50
Motor mass *1	kg	1	1	1	1	1	1
Allowable thrust load	N	30	30	30	30	30	30
Allowable radial load *2	N	100	100	100	100	100	100

Note: Directions of motor rotation and gear output shaft rotation are the same for models with reduction ratios 1:3.6 and 1:7.2, and opposite for reduction ratios 1:10, 1:20, 1:30 and 1:36.  
 \*1 Driver mass ▶ p. 45  
 \*2 When load is applied at 1/3 length from output shaft edge.

### Characteristics diagram

Winding current: 0.75A/phase

Allowable torque ——— Source current (no load) - - - - - Source current (load applied) ······  
 fs: Maximum self-start frequency when not loaded ●

**FB512M601S-CX3.6**  
**FB512M601D-CX3.6**

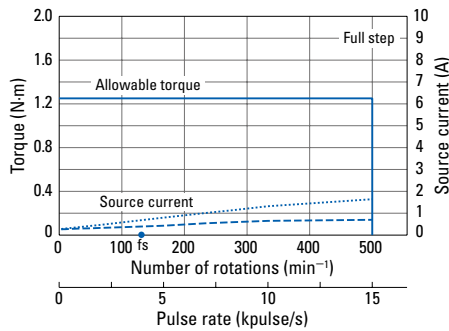

**FB512M601S-CX7.2**  
**FB512M601D-CX7.2**

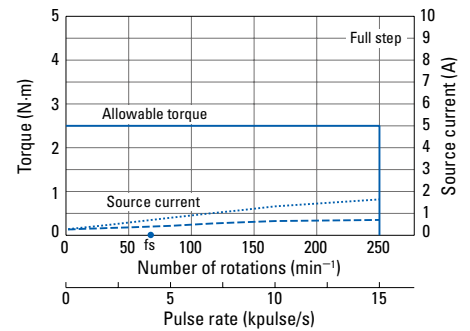

**FB512M601S-CX10**  
**FB512M601D-CX10**

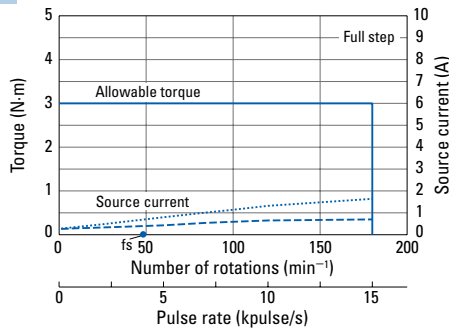

**FB512M601S-CX20**  
**FB512M601D-CX20**

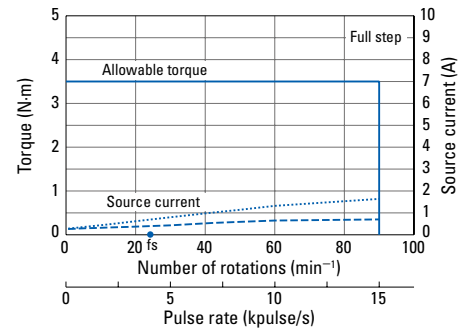

**FB512M601S-CX30**  
**FB512M601D-CX30**

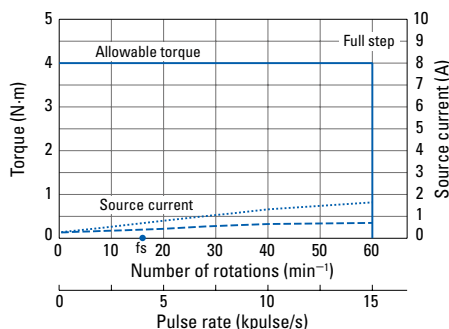

**FB512M601S-CX36**  
**FB512M601D-CX36**

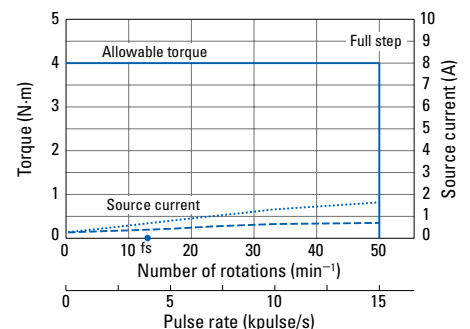

Size		86 mm sq. (angular dimension 90 mm sq.)					
		131 mm					
Single shaft	Motor size						
	Motor + gear length						
	Set model number	<b>FB512M861S-CX3.6</b>	<b>FB512M861S-CX7.2</b>	<b>FB512M861S-CX10</b>	<b>FB512M861S-CX20</b>	<b>FB512M861S-CX30</b>	<b>FB512M861S-CX36</b>
Configuration item: motor model number		SM5861-72CXA40	SM5861-72CXB40	SM5861-72CXE40	SM5861-72CXG40	SM5861-72CXJ40	SM5861-72CXK40
	Configuration item: driver model number	F5PAB075P100	F5PAB075P100	F5PAB075P100	F5PAB075P100	F5PAB075P100	F5PAB075P100
Dual shaft	Motor size						
	Motor + gear length						
	Set model number	<b>FB512M861D-CX3.6</b>	<b>FB512M861D-CX7.2</b>	<b>FB512M861D-CX10</b>	<b>FB512M861D-CX20</b>	<b>FB512M861D-CX30</b>	<b>FB512M861D-CX36</b>
Configuration item: motor model number		SM5861-72CXA10	SM5861-72CXB10	SM5861-72CXE10	SM5861-72CXG10	SM5861-72CXJ10	SM5861-72CXK10
	Configuration item: driver model number	F5PAB075P100	F5PAB075P100	F5PAB075P100	F5PAB075P100	F5PAB075P100	F5PAB075P100
Allowable torque	N·m	4.5	9	9	12	12	12
Rotor inertia	×10 <sup>-4</sup> kg·m <sup>2</sup>	1.48	1.48	1.48	1.48	1.48	1.48
Rated current	A/phase	0.75	0.75	0.75	0.75	0.75	0.75
Basic step angle	°	0.2	0.1	0.072	0.036	0.024	0.02
Gear ratio	—	1:3.6	1:7.2	1:10	1:20	1:30	1:36
Backlash	° or less	0.35	0.22	0.22	0.15	0.15	0.13
Allowable speed	min <sup>-1</sup>	500	250	180	90	60	50
Motor mass *1	kg	2.95	2.95	2.95	2.95	2.95	2.95
Allowable thrust load	N	60	60	60	60	60	60
Allowable radial load *2	N	300	300	300	300	300	300

Note: Directions of motor rotation and gear output shaft rotation are the same for models with reduction ratios 1:3.6 and 1:7.2, and opposite for reduction ratios 1:10, 1:20, 1:30 and 1:36.

\*1 Driver mass ▶ p. 45

\*2 When load is applied at 1/3 length from output shaft edge.

### Characteristics diagram

Winding current: 0.75A/phase

Allowable torque ——— Source current (no load) - - - - -  
 fs: Maximum self-start frequency when not loaded ● Source current (load applied) ······

**FB512M861S-CX3.6**  
**FB512M861D-CX3.6**

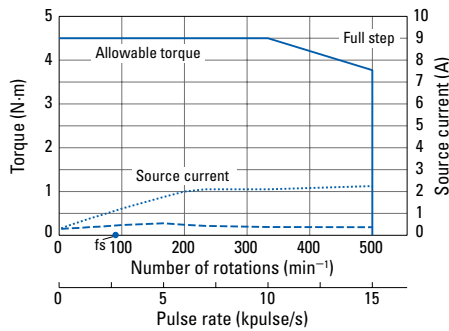

**FB512M861S-CX7.2**  
**FB512M861D-CX7.2**

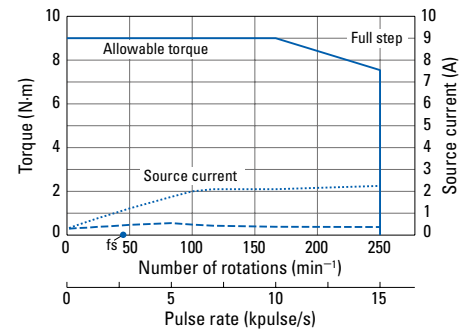

**FB512M861S-CX10**  
**FB512M861D-CX10**

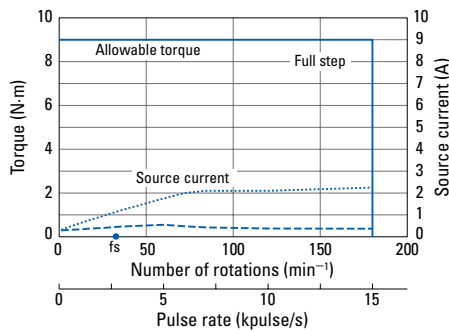

**FB512M861S-CX20**  
**FB512M861D-CX20**

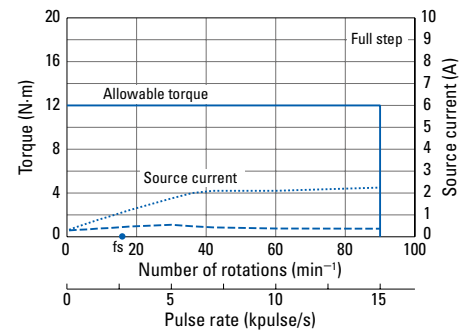

**FB512M861S-CX30**  
**FB512M861D-CX30**

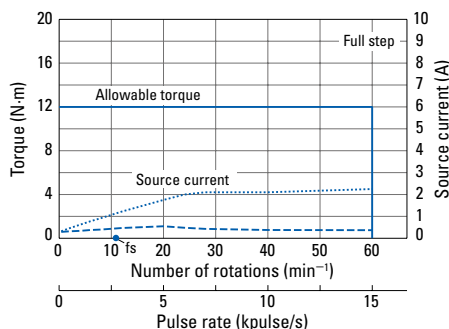

**FB512M861S-CX36**  
**FB512M861D-CX36**

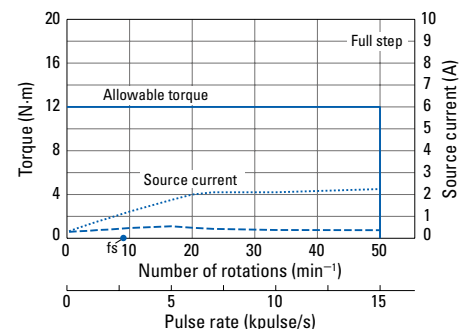

System Configuration Diagram ▶ p. 12 Set Model Configuration ▶ pp. 14 to 15 Motor Dimensions ▶ pp. 39 to 43 Driver Dimensions ▶ p. 45

If allowable torque is exceeded when using a motor with low-backlash gears, the gears may be damaged. When selecting a motor, ensure that its allowable torque will not be exceeded. Data is measured under the trial conditions of SANYO DENKI. Driving torque may vary according to actual machine precision.



Size	Motor size	42 mm sq.			60 mm sq.	
		74.4 mm			116.3 mm	
Single shaft	Set model number	<b>FB511M421S-HX30</b>	<b>FB511M421S-HX50</b>	<b>FB511M421S-HX100</b>	<b>FB512M601S-HX50</b>	<b>FB512M601S-HX100</b>
	Configuration item: motor model number	SM5421-32HXJ40	SM5421-32HXL40	SM5421-32HXM40	SM5601-72HXL40	SM5601-72HXM40
	Configuration item: driver model number	F5PAB035P100	F5PAB035P100	F5PAB035P100	F5PAB075P100	F5PAB075P100
Dual shaft	Set model number	<b>FB511M421D-HX30</b>	<b>FB511M421D-HX50</b>	<b>FB511M421D-HX100</b>	<b>FB512M601D-HX50</b>	<b>FB512M601D-HX100</b>
	Configuration item: motor model number	SM5421-32HXJ10	SM5421-32HXL10	SM5421-32HXM10	SM5601-72HXL10	SM5601-72HXM10
	Configuration item: driver model number	F5PAB035P100	F5PAB035P100	F5PAB035P100	F5PAB075P100	F5PAB075P100
Allowable torque	N·m	2.2	3.5	5	5.5	8
Momentary allowable torque	N·m	4.5	8.3	11	14	20
Rotor inertia	×10 <sup>-4</sup> kg·m <sup>2</sup>	0.04	0.04	0.04	0.23	0.23
Rated current	A/phase	0.35	0.35	0.35	0.75	0.75
Basic step angle	°	0.024	0.0144	0.0072	0.0144	0.0072
Gear ratio	—	1:30	1:50	1:100	1:50	1:100
Hysteresis loss	Arc min or less	3.6	2.4	2.4	—	—
Lost motion	Arc min	—	—	—	0.4 to 3 (±0.28 N·m)	0.4 to 1.5 (±0.4 N·m)
Allowable speed	min <sup>-1</sup>	116	70	35	70	35
Motor mass *1	kg	0.44	0.44	0.44	1.22	1.22
Allowable thrust load	N	1150	1150	1150	400	400
Allowable radial load *2	N	275	275	275	360	360

Note: The motor and gear output shaft rotate in the opposite direction.

\*1 Driver mass ▶ p. 45

\*2 When load is applied at 1/3 length from output shaft edge.

### Characteristics diagram

Momentary allowable torque --- Source current (no load) --- fs: Maximum self-start frequency when not loaded ●  
 Allowable torque — Source current (load applied) ·····

#### FB511M421S-HX30 FB511M421D-HX30

Winding current:  
0.35 A/phase

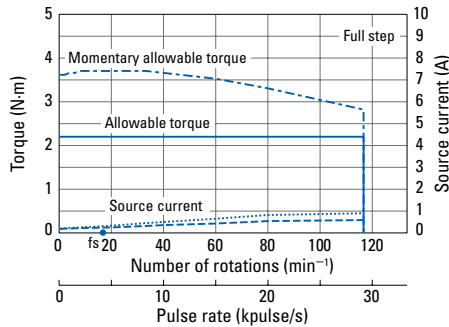

#### FB511M421S-HX50 FB511M421D-HX50

Winding current:  
0.35 A/phase

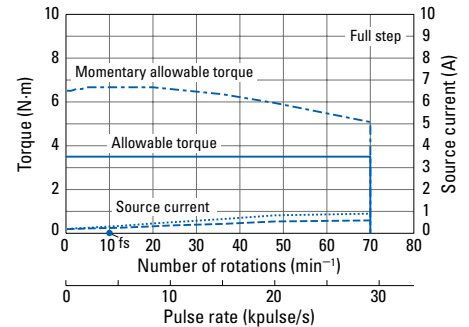

#### FB511M421S-HX100 FB511M421D-HX100

Winding current:  
0.35 A/phase

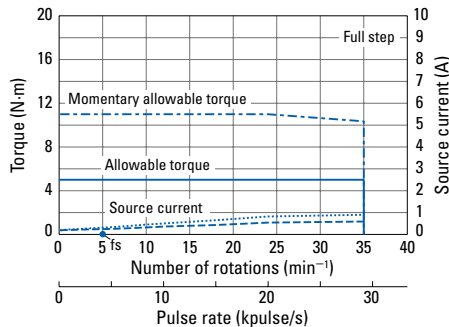

#### FB512M601S-HX50 FB512M601D-HX50

Winding current:  
0.75 A/phase

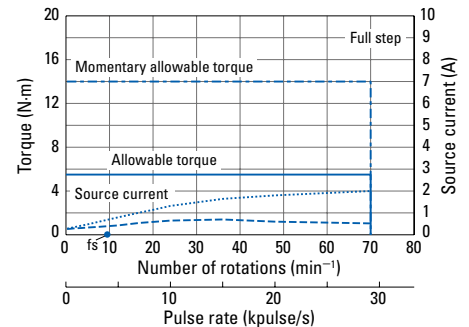

#### FB512M601S-HX100 FB512M601D-HX100

Winding current:  
0.75 A/phase

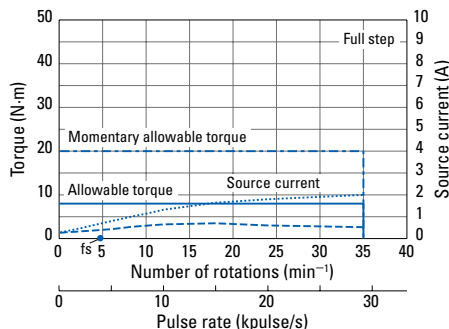

Size	Motor size	86 mm sq. (angular dimension 90 mm sq.)	
	Motor + gear length	148 mm	
Single shaft	Set model number	<b>FB512M861S-HX50</b>	<b>FB512M861S-HX100</b>
	Configuration item: motor model number	SM5861-72HXL40	SM5861-72HXM40
	Configuration item: driver model number	F5PAB075P100	
Dual shaft	Set model number	<b>FB512M861D-HX50</b>	<b>FB512M861D-HX100</b>
	Configuration item: motor model number	SM5861-72HXL10	SM5861-72HXM10
	Configuration item: driver model number	F5PAB075P100	
Allowable torque	N·m	25	40
Momentary allowable torque	N·m	34	59
Rotor inertia	$\times 10^{-4}$ kg·m <sup>2</sup>	1.68	1.68
Rated current	A/phase	0.75	0.75
Basic step angle	°	0.0144	0.0072
Gear ratio	—	1:50	1:100
Hysteresis loss	Arc min or less	—	—
Lost motion	Arc min	0.4 to 3 ( $\pm 1$ N·m)	0.4 to 3 ( $\pm 1.2$ N·m)
Allowable speed	min <sup>-1</sup>	70	35
Motor mass *1	kg	3.6	3.6
Allowable thrust load	N	1400	1400
Allowable radial load *2	N	1600	1600

Note: The motor and gear output shaft rotate in the opposite direction.

\*1 Driver mass ▶ p. 45

\*2 When load is applied at 1/3 length from output shaft edge.

### Characteristics diagram

Winding current: 0.75A/phase

Momentary allowable torque - - - - -  
Allowable torque —

Source current (no load) - - - - - fs: Maximum self-start frequency when not loaded ●  
Source current (load applied) · · · · ·

#### FB512M861S-HX50 FB512M861D-HX50

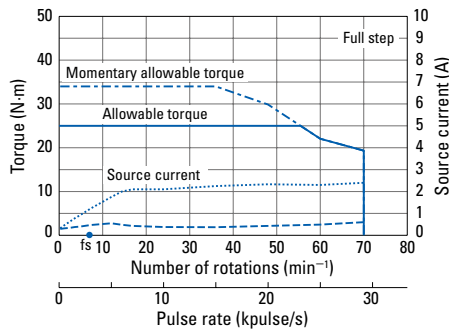

#### FB512M861S-HX100 FB512M861D-HX100

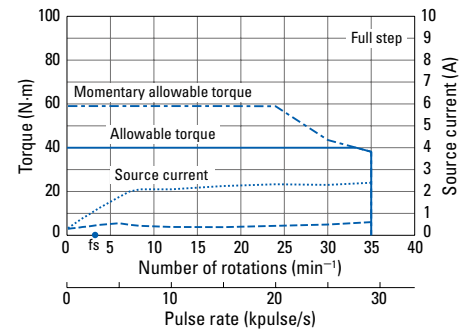

Basic step angle: 0.72°

Size	Motor size	42 mm sq.			60 mm sq.			
		68 mm	74.3 mm	82 mm	91.4 mm	102.6 mm	131.3 mm	
Single shaft	Motor + brake length							
	Set model number	<b>FB511M421S-XB</b>	<b>FB511M422S-XB</b>	<b>FB511M423S-XB</b>	<b>FB512M601S-XB</b>	<b>FB512M602S-XB</b>	<b>FB512M603S-XB</b>	
	Configuration item: motor model number	SM5421-32XB40	SM5422-32XB40	SM5423-32XB40	SM5601-72XB40	SM5602-72XB40	SM5603-72XB40	
	Configuration item: driver model number	F5PAB035P100	F5PAB035P100	F5PAB035P100	F5PAB075P100	F5PAB075P100	F5PAB075P100	
	Holding torque	N·m min.	0.13	0.185	0.245	0.57	0.9	1.7
	Rotor inertia	×10 <sup>-4</sup> kg·m <sup>2</sup>	0.043	0.06	0.071	0.36	0.47	0.76
	Rated current	A/phase	0.35	0.35	0.35	0.75	0.75	0.75
	Motor mass *1	kg	0.39	0.46	0.53	0.96	1.14	1.61
	Allowable thrust load	N	10	10	10	20	20	20
	Allowable radial load *2	N	56	54	52	191	183	170
Electromagnetic brake	Brake type	—	No excitation actuating type	No excitation actuating type	No excitation actuating type	No excitation actuating type	No excitation actuating type	No excitation actuating type
	Power supply input	V	24±5%	24±5%	24±5%	24±5%	24±5%	24±5%
	Power consumption	W	2.4 (75°C)	2.4 (75°C)	2.4 (75°C)	6 (75°C)	6 (75°C)	6 (75°C)
	Static friction torque	N·m min.	0.3	0.3	0.3	0.8	0.8	0.8
	Brake operating time	ms max.	20	20	20	20	20	20
	Brake release time	ms max.	30	30	30	30	30	30

\*1 Driver mass ▶ p. 45

\*2 The load point is at the tip of the output shaft.

### Characteristics diagram

With rubber coupling

Pull-out torque ———  
fs: Maximum self-start frequency when not loaded ●

Source current (no load) - - - - -

Source current (load applied) ······

#### FB511M421S-XB

Winding current:  
0.35 A/phase

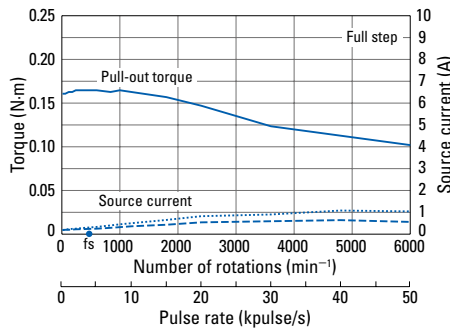

#### FB511M422S-XB

Winding current:  
0.35 A/phase

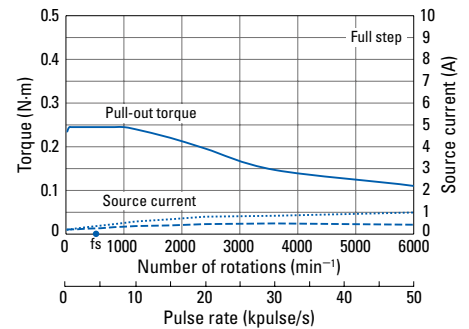

#### FB511M423S-XB

Winding current:  
0.35 A/phase

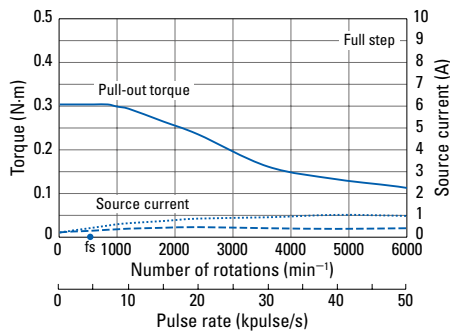

#### FB512M601S-XB

Winding current:  
0.75 A/phase

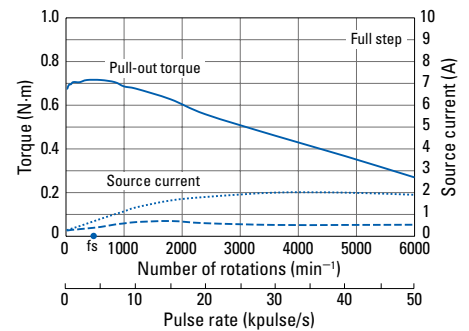

#### FB512M602S-XB

Winding current:  
0.75 A/phase

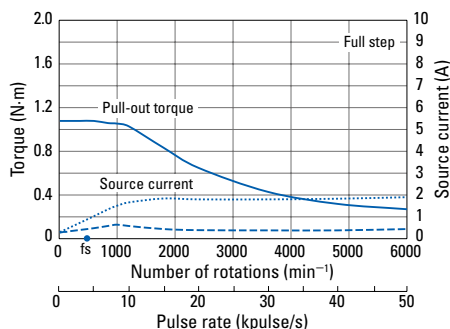

#### FB512M603S-XB

Winding current:  
0.75 A/phase

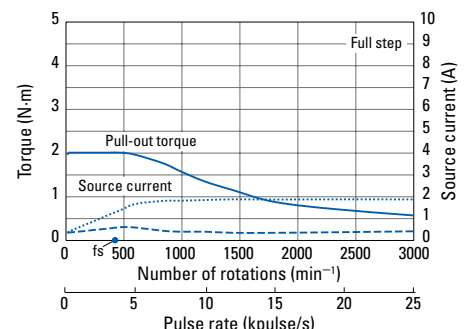

System Configuration Diagram ▶ p. 12 Set Model Configuration ▶ pp. 14 to 15 Motor Dimensions ▶ pp. 39 to 43 Driver Dimensions ▶ p. 45

The electromagnetic brake only works when the motor is stopped, and cannot be used for braking.

Data is measured under the trial conditions of SANYO DENKI. Driving torque may vary according to actual machine precision.

200 V series

## Electromagnetic brake model

AC input driver + Motor with electromagnetic brake

RoHS

Basic step angle: 0.72°

Size		86 mm sq.		
		119.5 mm	150 mm	180.4 mm
Single shaft	Motor size			
	Motor + brake length			
	Set model number	<b>FB512M861S-XB</b>	<b>FB512M862S-XB</b>	<b>FB512M863S-XB</b>
Configuration item: motor model number		SM5861-72XB40	SM5862-72XB40	SM5863-72XB40
	Configuration item: driver model number	F5PAB075P100	F5PAB075P100	F5PAB075P100
Holding torque	N·m min.	2.3	4.4	6.8
Rotor inertia	×10 <sup>-4</sup> kg·m <sup>2</sup>	2.55	4.07	5.57
Rated current	A/phase	0.75	0.75	0.75
Motor mass *1	kg	2.6	3.75	4.85
Allowable thrust load	N	60	60	60
Allowable radial load *2	N	200	200	200
Electromagnetic brake	Brake type	—	No excitation actuating type	No excitation actuating type
	Power supply input	V	24±10%	24±10%
	Power consumption	W	10.5 (20°C)	10.5 (20°C)
	Static friction torque	N·m min.	5	5
	Brake operating time	ms max.	20	20
	Brake release time	ms max.	50	50

\*1 Driver mass ▶ p. 45

\*2 The load point is at the tip of the output shaft.

### Characteristics diagram

Winding current: 0.75A/phase  
With rubber coupling

Pull-out torque ———  
fs: Maximum self-start frequency when not loaded ●

Source current (no load) - - - - -

Source current (load applied) ······

#### FB512M861S-XB

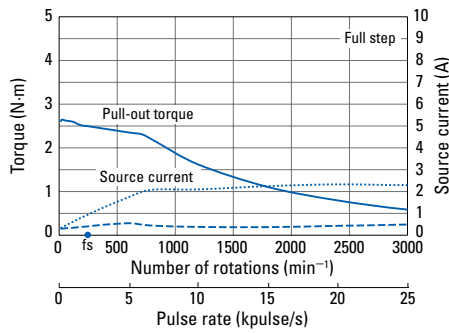

#### FB512M862S-XB

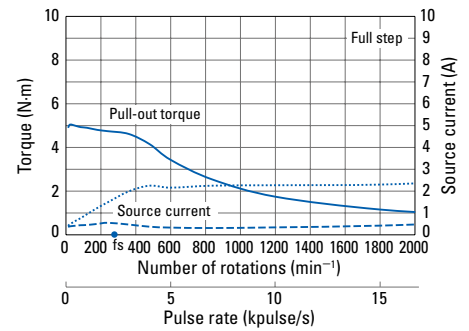

#### FB512M863S-XB

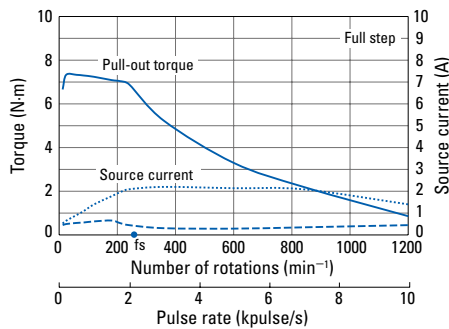

Basic step angle: 0.72°

Size	Motor size	42 mm sq.			60 mm sq.		
	Motor + encoder length	51.3 mm	57.6 mm	65.3 mm	65.6 mm	76.8 mm	105.5 mm
Single shaft	Set model number	FB511M421S-XE	FB511M422S-XE	FB511M423S-XE	FB512M601S-XE	FB512M602S-XE	FB512M603S-XE
	Configuration item: motor model number	SM5421-32XE40	SM5422-32XE40	SM5423-32XE40	SM5601-72XE40	SM5602-72XE40	SM5603-72XE40
	Configuration item: driver model number	F5PAB035P100	F5PAB035P100	F5PAB035P100	F5PAB075P100	F5PAB075P100	F5PAB075P100
Holding torque	N·m min.	0.13	0.185	0.245	0.57	0.9	1.7
Rotor inertia	×10 <sup>-4</sup> kg·m <sup>2</sup>	0.028	0.045	0.056	0.2	0.31	0.6
Rated current	A/phase	0.35	0.35	0.35	0.75	0.75	0.75
Motor mass *1	kg	0.33	0.4	0.47	0.68	0.86	1.33
Allowable thrust load	N	10	10	10	20	20	20
Allowable radial load *2	N	56	54	52	191	183	170
Encoder	Resolution	P/R	4000	4000	4000	4000	4000
	Number of channels	CH	3	3	3	3	3
	Output method	—	Line driver (C-MOS)	Line driver (C-MOS)	Line driver (C-MOS)	Line driver (C-MOS)	Line driver (C-MOS)
	Max. response frequency	kHz	220	220	220	220	220
	Power supply input	V	5±5%	5±5%	5±5%	5±5%	5±5%
Current consumption	mA max.	100	100	100	100	100	100

\*1 Driver mass ▶ p. 45

\*2 The load point is at the tip of the output shaft.

### Characteristics diagram

With rubber coupling

Pull-out torque ———  
fs: Maximum self-start frequency when not loaded ●

Source current (no load) - - - - -

Source current (load applied) ······

#### FB511M421S-XE

Winding current:  
0.35 A/phase

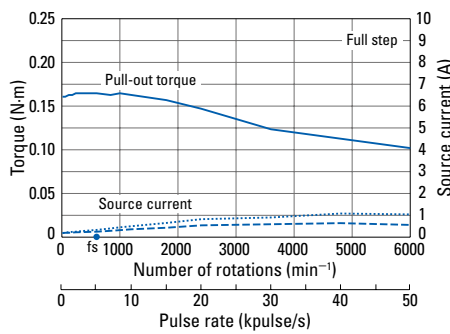

#### FB511M422S-XE

Winding current:  
0.35 A/phase

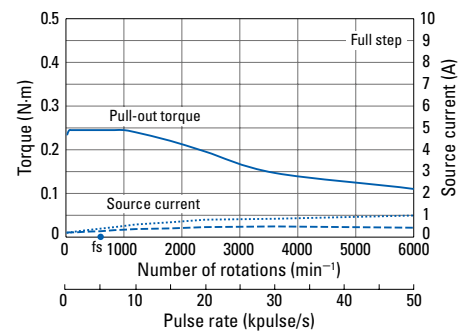

#### FB511M423S-XE

Winding current:  
0.35 A/phase

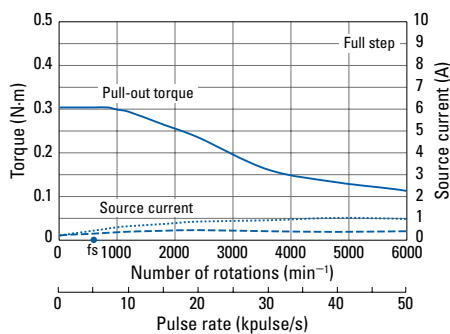

#### FB512M601S-XE

Winding current:  
0.75 A/phase

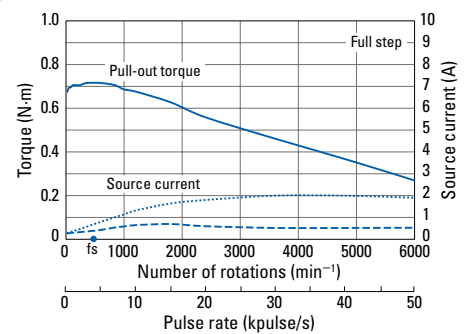

#### FB512M602S-XE

Winding current:  
0.75 A/phase

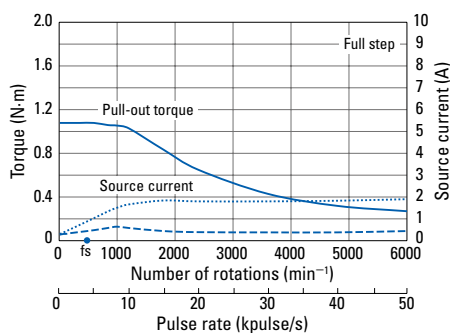

#### FB512M603S-XE

Winding current:  
0.75 A/phase

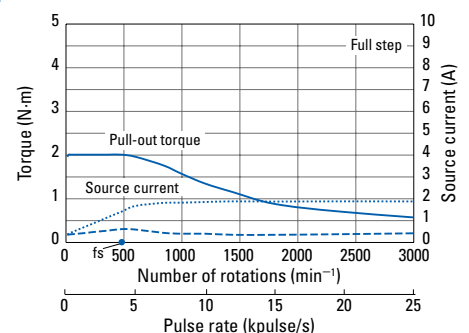

Basic step angle: 0.72°

Size	Motor size	86 mm sq.			
	Motor + encoder length	79.5 mm	110 mm	140.5 mm	
Single shaft	Set model number	<b>FB512M861S-XE</b>	<b>FB512M862S-XE</b>	<b>FB512M863S-XE</b>	
	Configuration item: motor model number	SM5861-72XE40	SM5862-72XE40	SM5863-72XE40	
	Configuration item: driver model number	F5PAB075P100	F5PAB075P100	F5PAB075P100	
Holding torque	N·m min.	2.3	4.4	6.8	
Rotor inertia	×10 <sup>-4</sup> ·kg·m <sup>2</sup>	1.48	3	4.5	
Rated current	A/phase	0.75	0.75	0.75	
Motor mass *1	kg	1.8	3	4.1	
Allowable thrust load	N	60	60	60	
Allowable radial load *2	N	200	200	200	
Encoder	Resolution	P/R	4000	4000	4000
	Number of channels	CH	3	3	3
	Output method	—	Line driver (C-MOS)	Line driver (C-MOS)	Line driver (C-MOS)
	Max. response frequency	kHz	220	220	220
	Power supply input	V	5±5%	5±5%	5±5%
	Current consumption	mA max.	100	100	100

\*1 Driver mass ▶ p. 45

\*2 The load point is at the tip of the output shaft.

### Characteristics diagram

Winding current: 0.75A/phase  
With rubber coupling

Pull-out torque ———  
fs: Maximum self-start frequency when not loaded ●

Source current (no load) - - - - -

Source current (load applied) ······

#### FB512M861S-XE

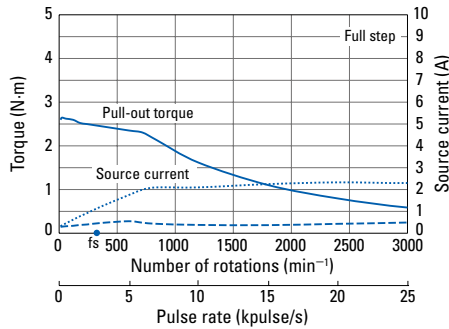

#### FB512M862S-XE

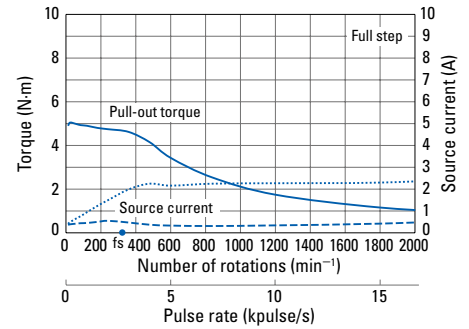

#### FB512M863S-XE

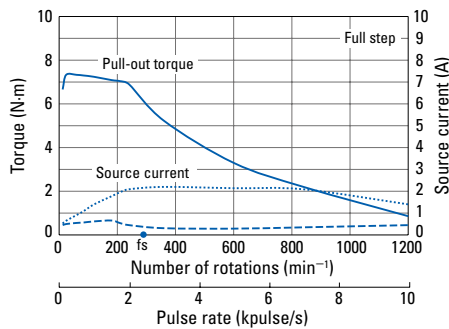





# Stepping Motor: Dimensions

 (Unit: mm)

## Low-backlash gear models

86 mm sq.

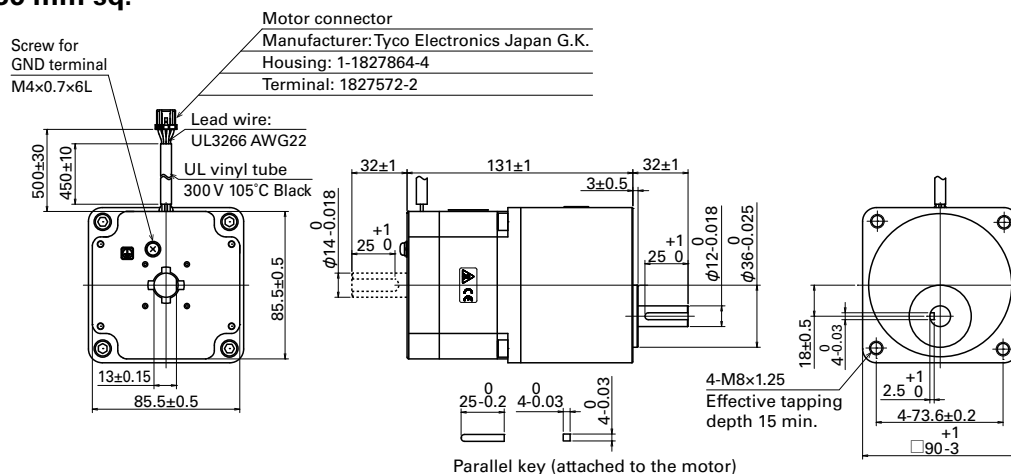

Set model number		Motor model number	
Single shaft	Dual shaft	Single shaft	Dual shaft
F□512M861S-CX3.6	F□512M861D-CX3.6	SM5861-72CXA40	SM5861-72CXA10
F□512M861S-CX7.2	F□512M861D-CX7.2	SM5861-72CXB40	SM5861-72CXB10
F□512M861S-CX10	F□512M861D-CX10	SM5861-72CXE40	SM5861-72CXE10
F□512M861S-CX20	F□512M861D-CX20	SM5861-72CXG40	SM5861-72CXG10
F□512M861S-CX30	F□512M861D-CX30	SM5861-72CXJ40	SM5861-72CXJ10
F□512M861S-CX36	F□512M861D-CX36	SM5861-72CXK40	SM5861-72CXK10

For '□' in the set model numbers, 'A' denotes 100 VAC and 'B' denotes 200 VAC.

## Harmonic gear models

42 mm sq.

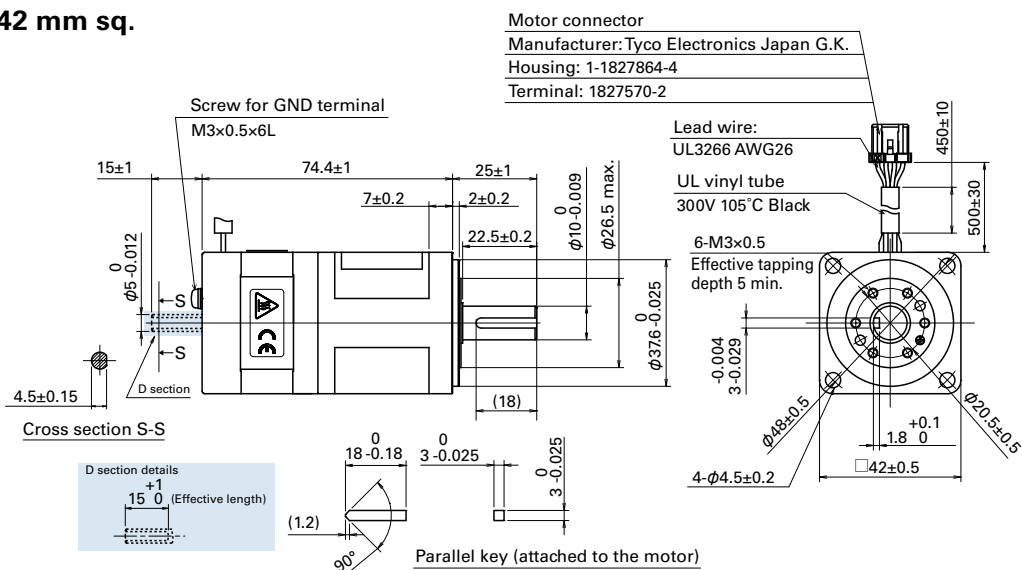

Set model number		Motor model number	
Single shaft	Dual shaft	Single shaft	Dual shaft
FA511M421S-HX30	FA511M421D-HX30	SM5421-32HXJ40	SM5421-32HXJ10
FB511M421S-HX30	FB511M421D-HX30		
FA511M421S-HX50	FA511M421D-HX50	SM5421-32HXL40	SM5421-32HXL10
FB511M421S-HX50	FB511M421D-HX50		
FA511M421S-HX100	FA511M421D-HX100	SM5421-32HXM40	SM5421-32HXM10
FB511M421S-HX100	FB511M421D-HX100		



## Harmonic gear models

### 60 mm sq.

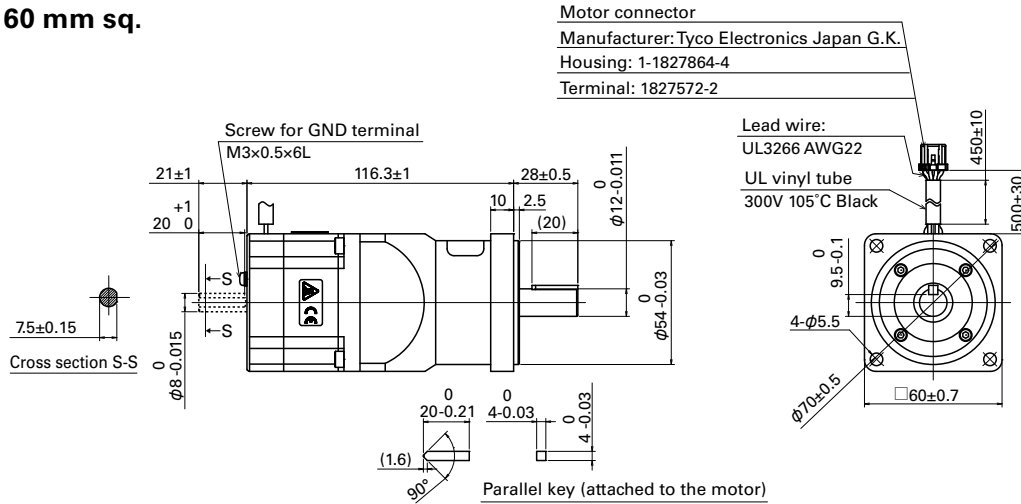

Set model number		Motor model number	
Single shaft	Dual shaft	Single shaft	Dual shaft
FA512M601S-HX50	FA512M601D-HX50	SM5601-72HXL40	SM5601-72HXL10
FB512M601S-HX50	FB512M601D-HX50		
FA512M601S-HX100	FA512M601D-HX100	SM5601-72HXM40	SM5601-72HXM10
FB512M601S-HX100	FB512M601D-HX100		

### 86 mm sq.

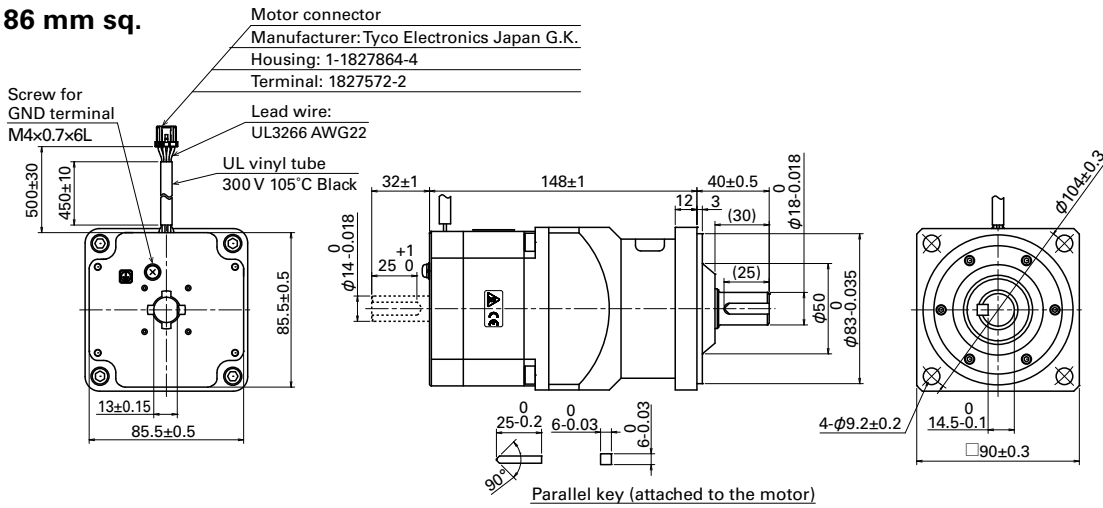

Set model number		Motor model number	
Single shaft	Dual shaft	Single shaft	Dual shaft
FA512M861S-HX50	FA512M861D-HX50	SM5861-72HXL40	SM5861-72HXL10
FB512M861S-HX50	FB512M861D-HX50		
FA512M861S-HX100	FA512M861D-HX100	SM5861-72HXM40	SM5861-72HXM10
FB512M861S-HX100	FB512M861D-HX100		

# Stepping Motor: Dimensions (Unit: mm)

## Electromagnetic brake models

### 42 mm sq.

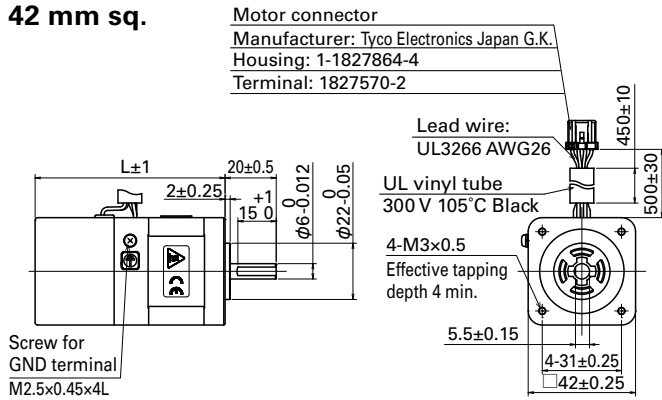

Set model number		Motor model number		Motor length (L)
Single shaft	Dual shaft	Single shaft	Dual shaft	
FA511M421S-XB	—	SM5421-32XB40	—	68
FB511M421S-XB	—	—	—	—
FA511M422S-XB	—	SM5422-32XB40	—	74.3
FB511M422S-XB	—	—	—	—
FA511M423S-XB	—	SM5423-32XB40	—	82
FB511M423S-XB	—	—	—	—

### 60 mm sq.

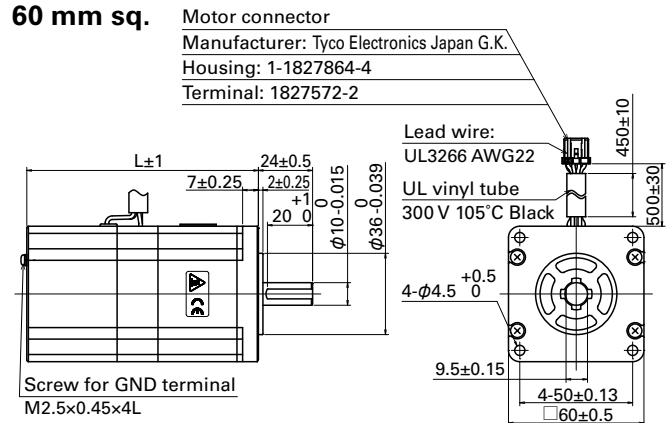

Set model number		Motor model number		Motor length (L)
Single shaft	Dual shaft	Single shaft	Dual shaft	
FA512M601S-XB	—	SM5601-72XB40	—	91.4
FB512M601S-XB	—	—	—	—
FA512M602S-XB	—	SM5602-72XB40	—	102.6
FB512M602S-XB	—	—	—	—
FA512M603S-XB	—	SM5603-72XB40	—	131.3
FB512M603S-XB	—	—	—	—

### 86 mm sq.

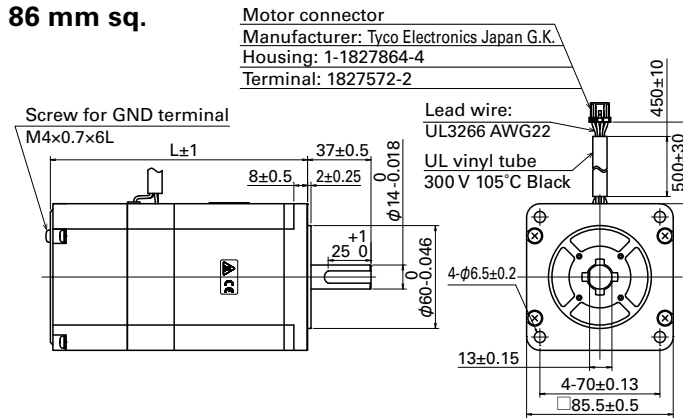

Set model number		Motor model number		Motor length (L)
Single shaft	Dual shaft	Single shaft	Dual shaft	
FA512M861S-XB	—	SM5861-72XB40	—	119.5
FB512M861S-XB	—	—	—	—
FA512M862S-XB	—	SM5862-72XB40	—	150
FB512M862S-XB	—	—	—	—
FA512M863S-XB	—	SM5863-72XB40	—	180.4
FB512M863S-XB	—	—	—	—

## Encoder models

### 42 mm sq.

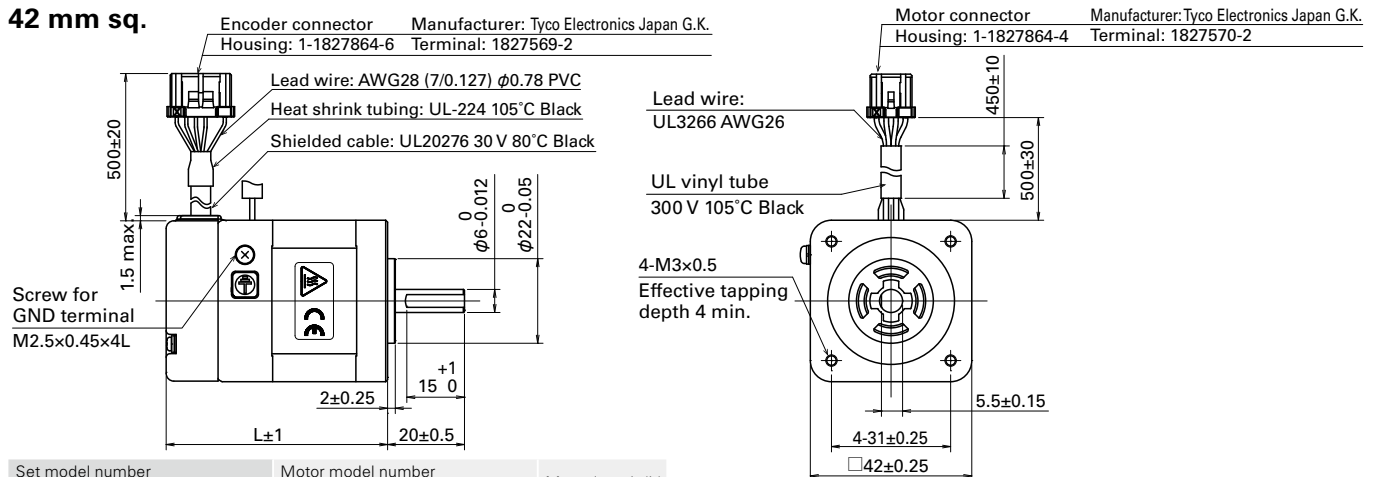

Set model number		Motor model number		Motor length (L)
Single shaft	Dual shaft	Single shaft	Dual shaft	
FA511M421S-XE	—	SM5421-32XE40	—	51.3
FB511M421S-XE	—	—	—	—
FA511M422S-XE	—	SM5422-32XE40	—	57.6
FB511M422S-XE	—	—	—	—
FA511M423S-XE	—	SM5423-32XE40	—	65.3
FB511M423S-XE	—	—	—	—

## Encoder models

### 60 mm sq.

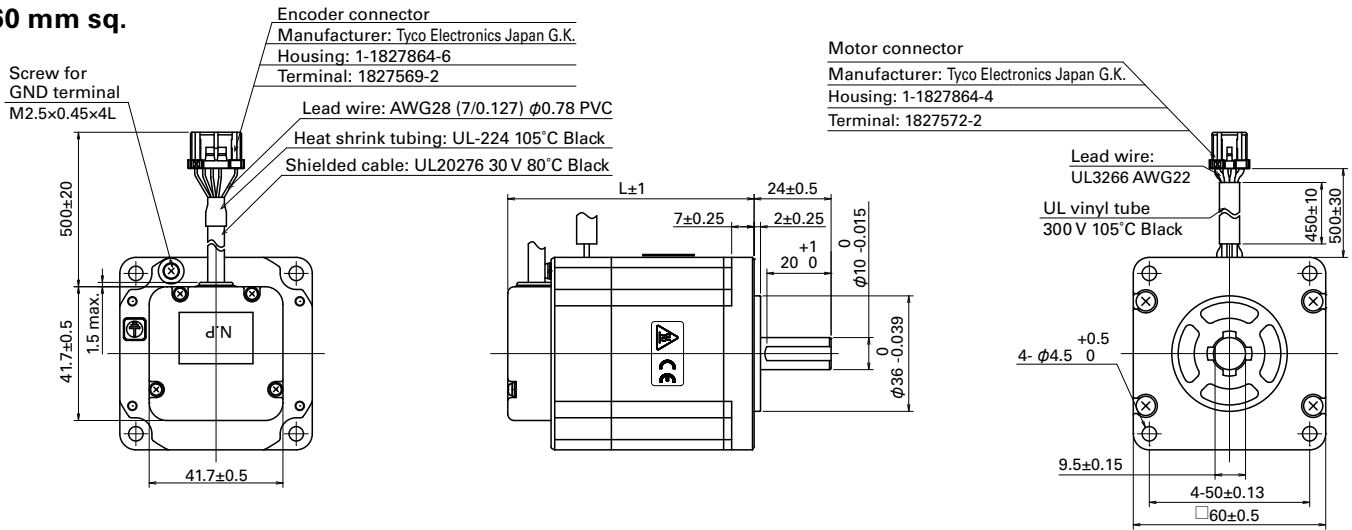

Set model number		Motor model number		Motor length (L)
Single shaft	Dual shaft	Single shaft	Dual shaft	
FA512M601S-XE	—	SM5601-72XE40	—	65.6
FB512M601S-XE	—	SM5602-72XE40	—	76.8
FA512M603S-XE	—	SM5603-72XE40	—	105.5

### 86 mm sq.

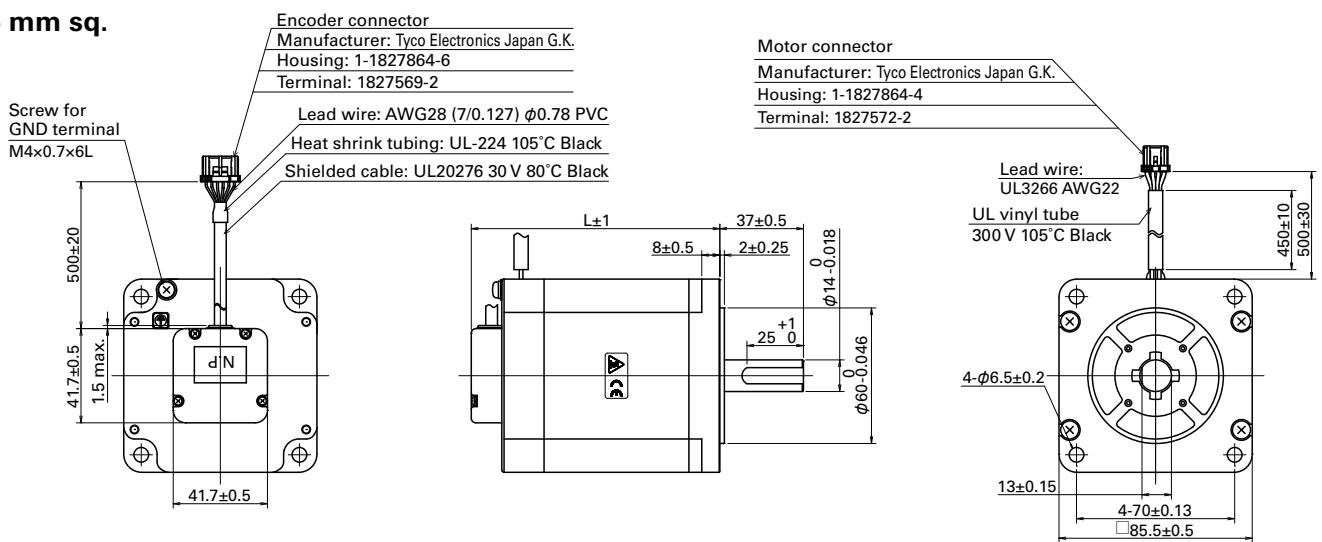

Set model number		Motor model number		Motor length (L)
Single shaft	Dual shaft	Single shaft	Dual shaft	
FA512M861S-XE	—	SM5861-72XE40	—	79.5
FB512M861S-XE	—	SM5862-72XE40	—	110
FA512M863S-XE	—	SM5863-72XE40	—	140.5

# Stepping Motor: General Specifications

Motor model number	SM542□	SM560□	SM586□
Type	S1 (continuous operation)		
Operating ambient temperature	-10°C to +40°C (0 to +40°C for harmonic gear model)		
Storage temperature	-20°C to +60°C		
Operating ambient humidity	95% RH max.: Under 40°C (no condensation)		
Storage humidity	95% RH max.: Under 40°C, 57% RH max.: Under 50°C, 35% RH max.: Under 60°C (no condensation)		
Operation altitude	1000 m or less above sea level		
Vibration resistance	Vibration frequency 10 to 500 Hz, total amplitude 1.52 mm (10 to 70 Hz), vibration acceleration 150 m/s <sup>2</sup> (70 to 500 Hz), sweep time 15 min/cycle, 12 sweeps in each X, Y and Z direction.		
Impact resistance	500 m/s <sup>2</sup> of acceleration for 11 ms with half-sine wave applying three times for X, Y and Z axes each, 18 times in total.		
Thermal class	F (+155°C)		
Withstandable voltage	At normal temperature and humidity, no failure with 1500 VAC @50/60 Hz applied for one minute between motor winding and frame.		
Insulation resistance	At normal temperature and humidity, not less than 100 MΩ between motor winding and frame by 500 VDC megger.		
Protection grade	IP40		
Winding temperature rise	85 K max. (Based on SANYO DENKI standard)		
Static angle error	±0.09°		
Thrust play *1	0.075 mm max. (load: 5 N)	0.075 mm max. (load: 10 N)	0.075 mm max. (load: 10 N)
Radial play *2	0.025 mm max. (load: 5 N)	0.025 mm max. (load: 5 N)	0.025 mm max. (load: 5 N)
Shaft runout	0.025 mm	0.025 mm	0.025 mm
Concentricity of mounting pilot relative to shaft	φ0.05 mm	φ0.075 mm	φ0.075 mm
Squareness of mounting surface relative to shaft	0.1 mm	0.1 mm	0.15 mm
Direction of motor mounting	Can be freely mounted vertically or horizontally		

\*1 Thrust play: Shaft displacement under axial load.

\*2 Radial play: Shaft displacement under radial load applied 1/3rd of the length from the end of the shaft.

## Safety standards

CE marking	Directives	Applicable standard
	Low-voltage directives (2014/35/EU)	EN60034-1, EN60034-5

UL	Acquired standards	Applicable standard	File No.
	UL	UL1004-1, UL1004-6	E179832 (PRHZ2)
	cUL *3	CSA C22.2 No.100	E179832 (PRHZ8)

\*3 SM542□ type is not cUL compliant.

# Internal Wiring and Rotation Direction

## Internal wire connection

Connection Method:

New pentagon connection

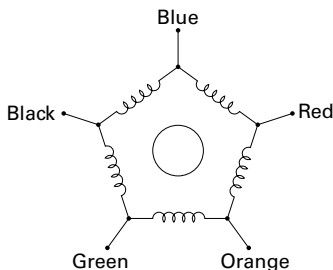

## Direction of motor rotation

When excited by a direct current in the order shown below, the direction of rotation is clockwise as viewed from the output shaft side.

\*This is an instance of the standard model and the electromagnetic brake model.

As for some of the models with the gear, the direction of motor rotation is different, please make inquiries.

	Exciting order										
		1	2	3	4	5	6	7	8	9	10
Lead wire color	Blue			+	+	+		-	-	-	
	Red	-	-			+	+	+			-
	Orange		-	-	-			+	+	+	
	Green	+			-	-	-			+	+
	Black	+	+	+				-	-	-	

# Driver Dimensions (Unit: mm)

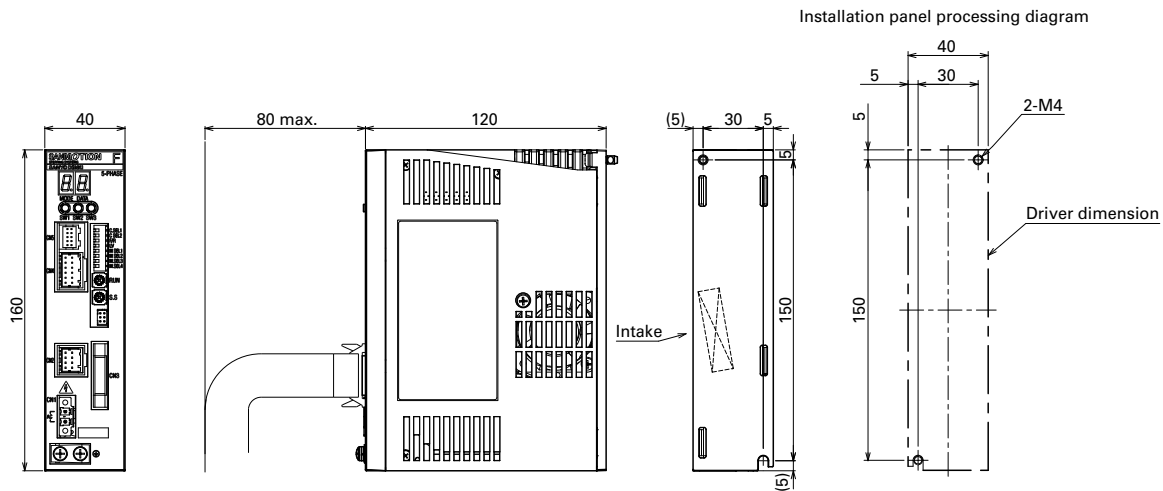

## Driver Specifications

### General specifications

	Model number	F5PAA035P100	F5PAA075P100	F5PAB035P100	F5PAB075P100	
	Input source	Single Phase 100 to 120 VAC +10, -15%, 50/60 Hz		Single Phase 200 to 240 VAC +10, -15%, 50/60 Hz		
	Source current	2A	4A	1.5A	3A	
Basic specifications	Environment	Protection class	Class I			
		Operation environment	Installation category (over-voltage category): II, pollution degree: 2			
		Operating ambient temperature	0 to +55°C			
		Storage temperature	-20 to +70°C			
		Operating ambient humidity	90% RH max. (no condensation)			
		Storage humidity	90% RH max. (no condensation)			
		Operation altitude	1000 m or less above sea level			
		Vibration resistance	Tested under the following conditions: 5 m/s <sup>2</sup> frequency range 10 to 55 Hz, direction along X, Y and Z axes, for 2 hours each			
		Impact resistance	20 m/s <sup>2</sup>			
		Withstandable voltage	Not influenced when 1.5 kVAC is applied between power input terminal and cabinet for one minute.			
		Insulation resistance	10 MΩ min. when measured with 500 VDC megohmmeter between input terminal and cabinet.			
	Mass	0.65 kg				
Functions	Selection functions	Control mode, pulse input type, low-vibration mode, motor select, step angle, operating current				
	Protection functions	Overvoltage protection, power supply voltage reduction protection, overheat protection, overcurrent protection				
	LED indication	Status display, alarm display				
I/O signals	Command pulse input signal	Open collector terminal	Photocoupler input system; input resistance: 470 Ω Input-signal "H" level: 4.5 to 5.5 V, input-signal "L" level: 0 to 0.5 V Maximum input frequency: 400 kpulse/s			
		Line driver terminal	Photocoupler input system; input resistance: 150 Ω Input-signal "H" level: 3.0 to 3.5 V, input-signal "L" level: 0 to 0.5 V Maximum input frequency: 400 kpulse/s			
	Input signal	Photocoupler input system; input resistance: 2.2 kΩ Input-signal "H" level: 4.75 to 26.4 V, input-signal "L" level: 0 to 1.0 V				
	Output signal	From the photocoupler by the open collector output Output specification: V <sub>ceo</sub> = 4.75 to 26.4 V, I <sub>c</sub> = 10 mA max.				

### Safety standards

	Directives	Standard	Name
CE (TÜV)	Low-voltage directives	EN61800-5-1	—
	EMC directives	EN61800-3	—
		EN61000-6-2 EN61000-6-4	—
UL	Acquired standards	Applicable standard	File No.
	UL	UL508C	E179775
	UL for Canada (c-UL)		
KC Mark (Korea Certification Mark)	Standard		
		KN61000-6-2, KN61000-6-4	

- EMC characteristics may vary depending on the configuration of the users' control panel, which contains the driver or stepping motor, or the arrangement and wiring of other electrical devices.
- Parts for EMC noise suppression like noise filters and toroidal type ferrite cores may be required depending on circumstances.
- Validation test of driver has been performed for low-voltage EMC directives at TÜV (TÜV product service) for self-declaration of CE marking.

# Driver Controls and Connectors

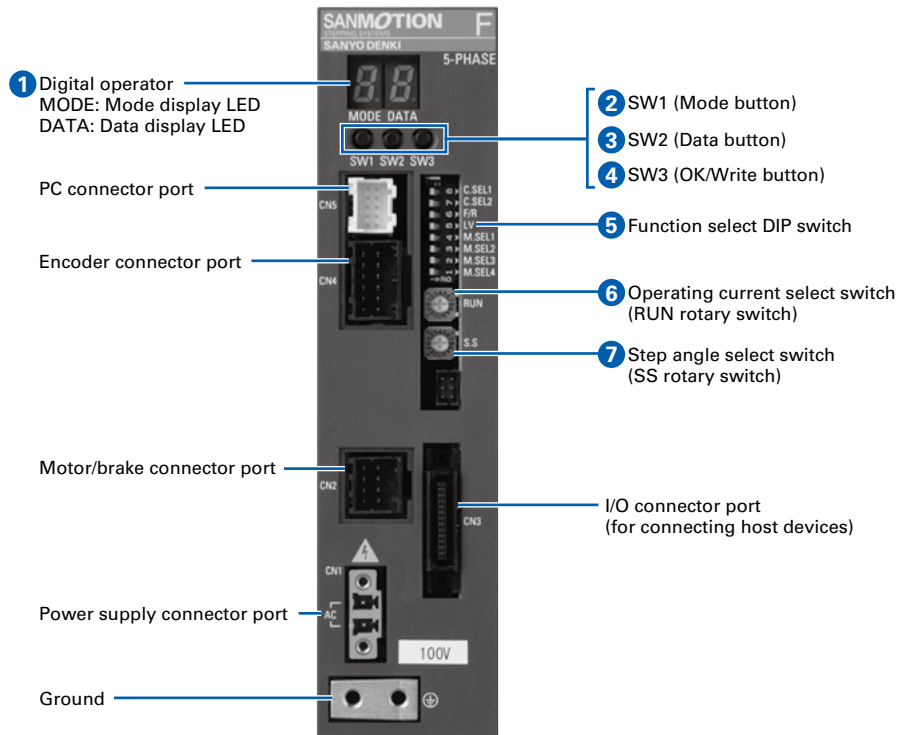

## 1 Digital operator

Allows specific parameters to be set, and for jog operations.

- **MODE** (Mode display LED)

Displays the current mode number.

MODE	Functions	Data range (DATA display)	Factory setting
0	Driver status display	Displays the driver status	—
4	Current settings when stopped	0-F (100%-25%)	A (50%)
5	Step division mode settings	2=2-phase; 5=5-phase	5 (5-phase)
6	Step division 2 settings	0-F (same as SS rotary switch)	0 (1 division)
7	Excitation select	0= Excitation origin, 1= Power shutdown excitation phase	0 (excitation origin)
8	Jog operation speed	1-F (100 min <sup>-1</sup> /LSB)	1 (100 min <sup>-1</sup> )
9	Jog operation	—	—
A	Alarm code display	Displays the alarm code	—
B	Settings control	0= Settings control disabled, 1 to F (small effect to large effect)	0 (disabled)

- **DATA** (data display LED)

Displays monitor and parameter setting values. Blinks when the displayed parameter setting value is different from the current setting value.

## 2 SW1 (Mode button)

## 3 SW2 (Data button)

## 4 SW3 (OK/Write button)

Used for each setting in conjunction with the digital operator. See the operation manual for details on the settings. Download the necessary manual from the Product Information page on our website.

## 5 Function select DIP switch

Sets the control mode, input pulse type, low-vibration mode, and motor select.

SW No.	Symbol	Functions
8	C.SEL1	Control mode select
7	C.SEL2	
6	F/R	Input pulse type select
5	LV	Low-vibration mode select
4	M.SEL1	Motor select
3	M.SEL2	
2	M.SEL3	
1	M.SEL4	

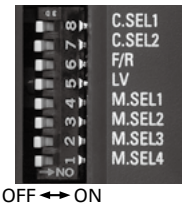

- Set the DIP switches while the power supply is shut off. These settings cannot be changed after the power has been turned on.
- Factory settings are LV set to ON and all others set to OFF.

## 6 Operating current select switch (RUN rotary switch)

Sets the operating current.

Dial	0	1	2	3	4	5	6	7
Stepping motor current (%)	100	95	90	85	80	75	70	65
Dial	8	9	A	B	C	D	E	F
Stepping motor current (%)	60	55	50	45	40	35	30	25

- The factory setting is F (25%).

## 7 Step angle select switch (SS rotary switch)

Sets the step division 1 settings.

5-phase mode Digital operator MODE5 is set to 5.				2-phase mode Digital operator MODE5 is set to 2.			
SS settings	Number of divisions	Resolution	Basic step angle	SS settings	Number of divisions	Resolution	Basic step angle
0	1	500	0.72°	0	0.4	200	1.8°
1	2	1000	0.36°	1	0.8	400	0.9°
2	2.5	1250	0.288°	2	1.6	800	0.45°
3	4	2000	0.18°	3	2	1000	0.36°
4	5	2500	0.144°	4	3.2	1600	0.225°
5	8	4000	0.09°	5	4	2000	0.18°
6	10	5000	0.072°	6	6.4	3200	0.1125°
7	20	10000	0.036°	7	10	5000	0.072°
8	25	12500	0.0288°	8	12.8	6400	0.05625°
9	40	20000	0.018°	9	20	10000	0.036°
A	50	25000	0.0144°	A	25.6	12800	0.028125°
B	80	40000	0.009°	B	40	20000	0.018°
C	100	50000	0.0072°	C	50	25000	0.0144°
D	125	62500	0.00576°	D	51.2	25600	0.0140625°
E	200	100000	0.0036°	E	100	50000	0.0072°
F	250	125000	0.00288°	F	102.4	51200	0.00703125°

- The factory setting is 1.
- Step division 1 and step division 2 can be used while switching with the I/O signal.
- Step division setting 2 can be set in the Mode 6 of the digital operator.

## Control mode select

Select the stepping motor control mode.

SW8 C.SEL1	SW7 C.SEL2	Control mode
OFF	OFF	Normal mode
ON	OFF	Analysis mode
OFF	ON	Reserved (do not set)
ON	ON	Reserved (do not set)

- Normal mode  
Controls general stepping motor operations.
- Analysis mode  
Encoder models can detect step-out, monitor speed, monitor the current position, etc.

## Input pulse type select

Select the input pulse type.

SW6 F/R	Input pulse type
OFF	2-input type (CW pulse/CCW pulse)
ON	1-input type (Pulse/Direction)

## Low-vibration mode select

Allows for smooth operation with low vibrations, even with step division set at coarse resolution.

SW5 LV	Operation
OFF	Microstep operation
ON	Low vibration operation

During low vibration operation, operational processes for the driving pulse will be carried out inside the driver. For this reason, motor movement will be delayed by 1 pulse for each input pulse.

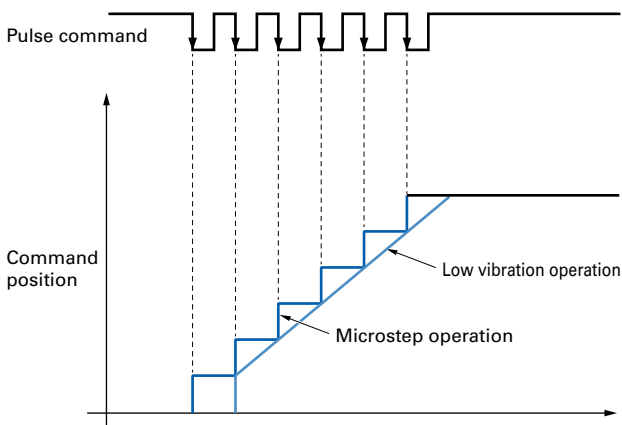

## Motor select

Select a motor to be used with the driver.

Driver model number: F5PAA035P100, F5PAB035P100

SW4 M.SEL1	SW3 M.SEL2	SW2 M.SEL3	SW1 M.SEL4	Motor model number
OFF	OFF	OFF	OFF	SM5421-32□□
ON	OFF	OFF	OFF	SM5422-32□□
OFF	ON	OFF	OFF	SM5423-32□□
Other settings				Reserved

Driver model number: F5PAA075P100, F5PAB075P100

SW4 M.SEL1	SW3 M.SEL2	SW2 M.SEL3	SW1 M.SEL4	Motor model number
ON	OFF	ON	OFF	SM5601-72□□
OFF	ON	ON	OFF	SM5602-72□□
ON	ON	ON	OFF	SM5603-72□□
OFF	OFF	OFF	ON	SM5861-72□□
ON	OFF	OFF	ON	SM5862-72□□
OFF	ON	OFF	ON	SM5863-72□□
Other settings				Reserved



# Connections and Signals

## External wiring diagram

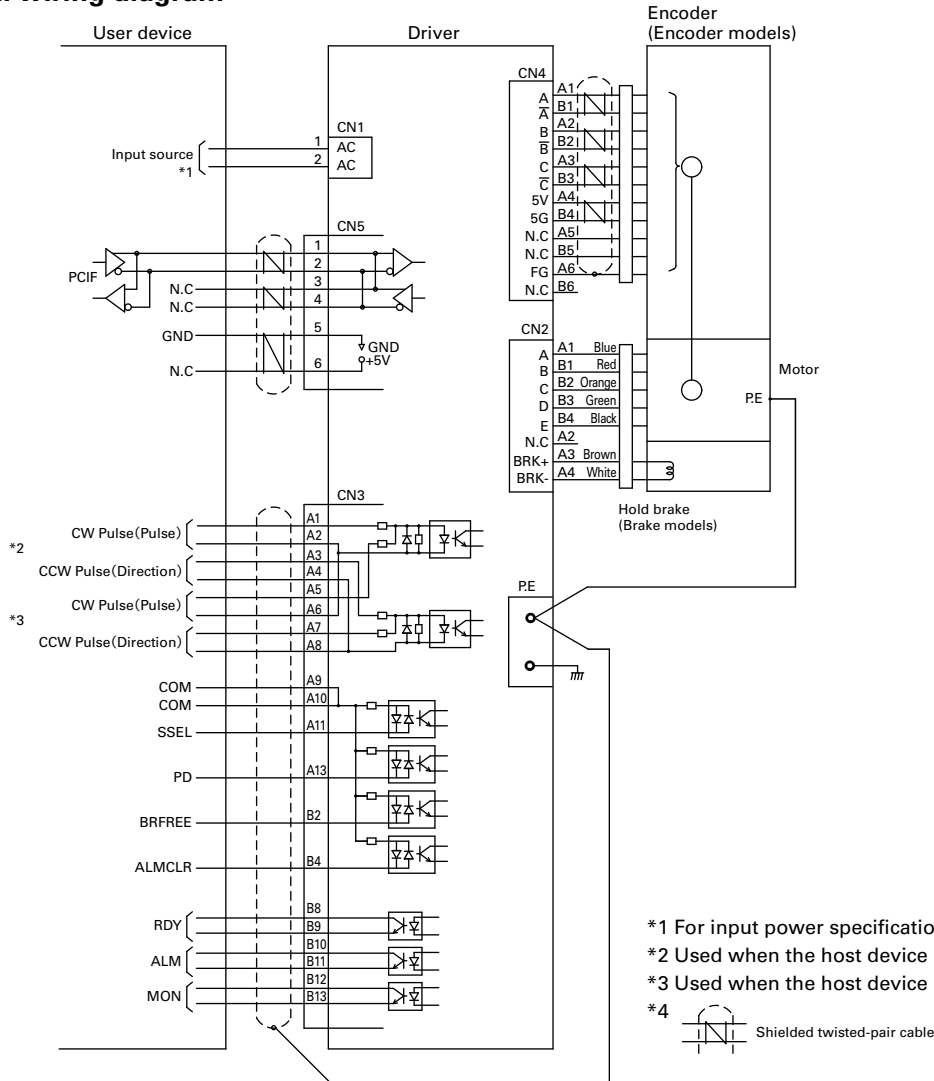

## Wiring

### Connector model, compatible wires

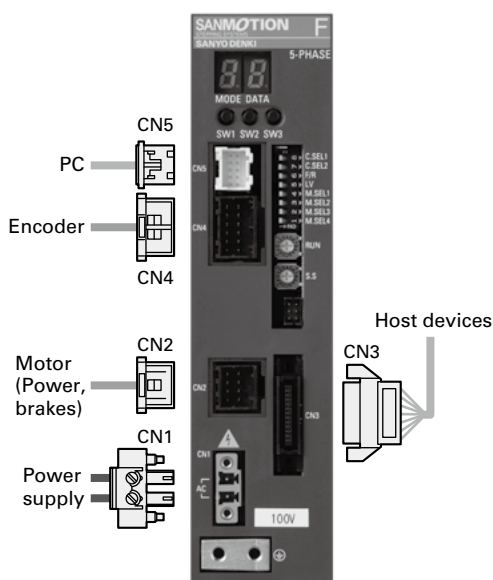

Applicable use	Code	Name	Model	Compatible wires	Wire length	Manufacturer
Power supply	CN1	Socket (Driver side)	MC1,5/2-GF-5,08	AWG18 Discrete line	3 m max.	PHOENIX CONTACT
		Plug	MC1,5/2-STF-5,08			
Power, brakes (for 60 mm sq. and 86 mm sq.)	CN2	Tab header (Driver side)	1-1827876-4	AWG18 to 22 Discrete line *1	20 m max.	Tyco Electronics Japan G.K.
		Recessed housing	1-1827864-4			
		Recessed contact	1827572-2			
Power, brakes (for 42 mm sq.)	CN2	Tab header (Driver side)	1-1827876-4	AWG22 to 26 Discrete line *2	20 m max.	Tyco Electronics Japan G.K.
		Recessed housing	1-1827864-4			
		Recessed contact	1827570-2			
I/O	CN3	Plug (Driver side)	8831E-026-170LD-F	AWG28 (7/0.127)	2 m max.	KEL CORPORATION
		Receptacle	8822E-026-171D			
Encoder	CN4	Tab header (Driver side)	1-1827876-6	AWG22 to 28 Shielded twisted pair	20 m max.	Tyco Electronics Japan G.K.
		Recessed housing	1-1827864-6			
		Recessed contact	1827570-2			
Communications	CN5	Post with base (Driver side)	S10B-PADSS-1GW	AWG24 to 28 Shielded twisted pair	2 m max.	J.S.T Mfg Co., Ltd.
		housing	PADP-10V-1-S			
		Contact	SPH-002GW-P0.5S			

\*1: When extending the power line more than 3 m, we recommend using AWG 18 or AWG 20 wire.

\*2: When extending the power line more than 3 m, we recommend using a wire thicker than AWG 22 wire. (When using AWG 18 or AWG 20 wire, use a recessed contact 1827572-2)

# Wiring

## Wiring

### Power supply connector (CN1)

Pin No.	Symbol	Signal name
1	AC	AC
2	AC	AC

- Do not wire the motor power line, I/O cable, or encoder cable together with the power cable inside the same duct.
- Make sure to wait for at least 10 minutes after shutting down the power, before plugging or unplugging the power cable. Failure to do so may cause damage to the driver.
- Select the appropriate breaker, electromagnetic contactor, and noise filter after referring to the details in the Operation Manual on power supply current, inrush current, and leakage current.

### Power connector (CN2)

Pin No.	Signal name	Lead wire color
A1	Power A phase	Blue
B1	Power B phase	Red
A2	—	—
B2	Power C phase	Orange
A3	Hold brake +	Brown
B3	Power D phase	Green
A4	Hold brake -	White
B4	Power E phase	Black

- The color of the lead wires on the hold brake vary with the polarity. Hold brakes without polarity use the same lead wire color.
- The power supply for the hold brake is inside of the driver. The hold brake is automatically controlled by the driver.
- Make sure to wait for at least 10 minutes after shutting down the power before plugging or unplugging the power lines. Failure to do so may cause damage to the driver.

### I/O signal connector (CN3)

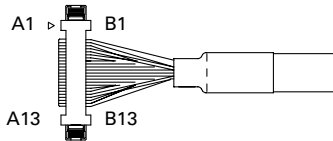

Pin No.	Signal name	Functions	Lead wire color	Mark display	Mark color
A1	CW Pulse/ Pulse	CW pulse/pulse (for open collector)	Orange		Red
A2	—	—	—		Black
A3	CCW Pulse/ DIR	CCW pulse/direction (for open collector)	Gray		Red
A4	—	—	—		Black
A5	CW Pulse/ Pulse	CW pulse/pulse (for line driver)	White		Red
A6	—	—	—		Black
A7	CCW Pulse/ DIR	CCW pulse/direction (for line driver)	Yellow		Red
A8	—	—	—		Black
A9	COM	—	—		Red
A10	COM	Input common	Pink		Black
A11	SSEL	Step angle selection input	Orange		Red
A12	—	—	—		Black
A13	PD	Power down input	Gray		Red
B1	—	—	—		Black
B2	BRFREE	Brake free input	White		Red
B3	—	—	—		Black
B4	ALMCLR	Alarm clear input	Yellow		Red
B5	—	—	—		Black
B6	—	—	—		Red
B7	—	—	—		Black
B8	RDY+	Operation ready output	Orange		Red
B9	RDY-	—	—		Black
B10	ALM+	Alarm output	Gray		Red
B11	ALM-				Black
B12	MON+	Phase origin monitor output	White		Red
B13	MON-				Black

\*Setup software and a communications unit are necessary to set I/O signal logic. Refer to the operation manual when preparing.

### Encoder connector (CN4)

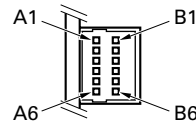

Pin No.	Signal name	Lead wire color
A1	A phase +	Blue
B1	A phase -	Brown
A2	B phase +	Green
B2	B phase -	Purple
A3	Z phase +	White
B3	Z phase -	Yellow
A4	VCC	Red
B4	GND	Black
A5	—	—
B5	—	—
A6	FG	Black
B6	—	—

### Communications connector (CN5)

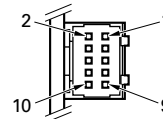

Pin No.	Signal name	Lead wire color
1	A	Yellow
2	B	White
3	(A)	—
4	(B)	—
5	GND	Black
6	(VCC)	—
7	—	—
8	—	—
9	—	—
10	—	—

# Pulse Command Input

## Connection example

Connection to line driver output	Connect to open collector output
Pulse crest value "H" level: 3.0 to 3.5 V "L" level: 0 to 0.5 V	Pulse crest value "H" level: 4.5 to 5.5 V "L" level: 0 to 0.5 V
	If the peak voltage of the input signal exceeds 5.5 V, please add an external current-limiting resistor R to limit the input current to around 7 mA. (Take the photocopier forward voltage of 1.5 V into consideration.)

## Pulse waveform

Maximum response frequency: 400 kpulse/s

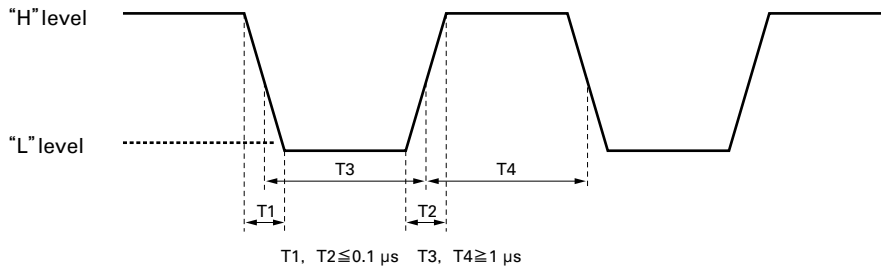

· Note that the unit cannot be operated at maximum speed if the step division is high due to maximum response frequency limits.

## Timing chart

### ◆ 2-input type

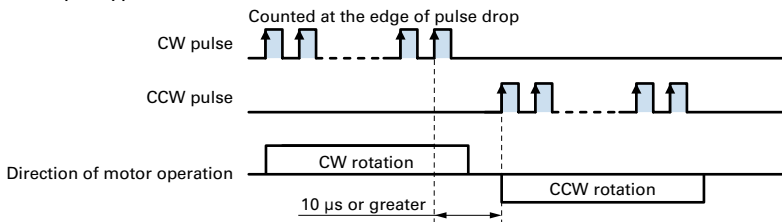

- indicates that the photocopier is ON.
- CW rotation means rotation in a clockwise direction when viewed from the motor flange side; and CCW rotation means rotation in a counterclockwise direction when viewed from the motor flange side.
- Do not input CW/CCW pulses at the same time.
- The CW/CCW pulse switching time of "10 μs or greater" is the operating time for the driver internal circuit, not the motor response time. Set a time in which the motor can respond for actual operations.
- 1-input type and 2-input type can be switched by setting the DIP switch: F/R.

### ◆ 1-input type (leading edge operation)

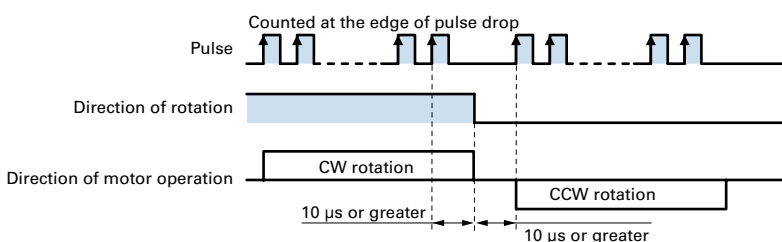

- indicates that the photocopier is ON.
- CW rotation means rotation in a clockwise direction when viewed from the motor flange side; and CCW rotation means rotation in a counterclockwise direction when viewed from the motor flange side.
- The rotating direction switching time of "10 μs or greater" is the operating time for the driver internal circuit, not the motor response time. Set a time in which the motor can respond for actual operations.
- 1-input type and 2-input type can be switched by setting the DIP switch: F/R.

# Input Signal

## Connection example

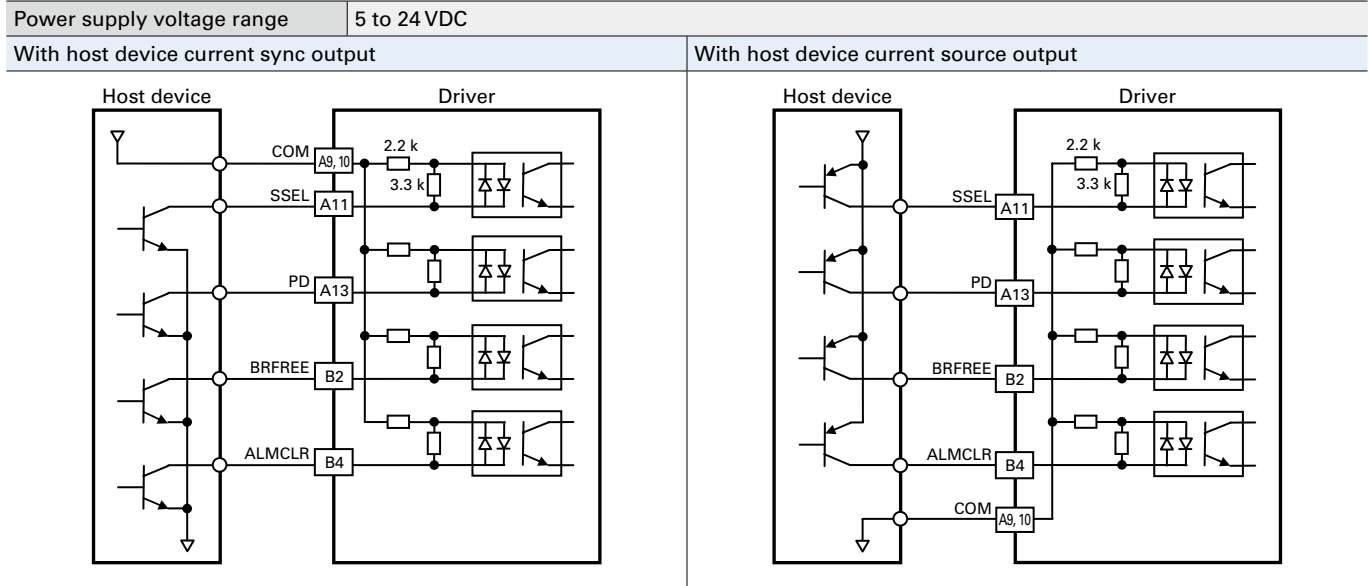

# Output Signal

## Connection example

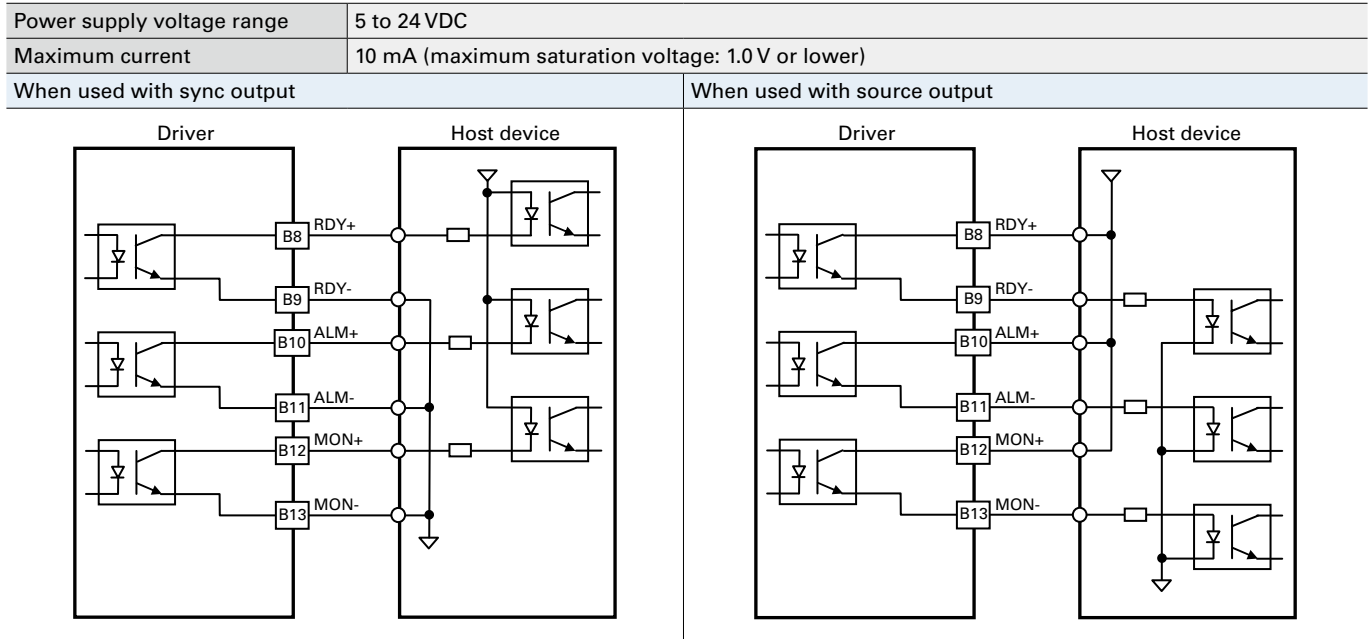

# DC Input Set Models/Drivers

## Microstep

Set Model Configuration ▶ p. 54 Specifications/Characteristics Diagram ▶ pp. 56 to 70 Motor Dimensions ▶ pp. 71 to 74  
 Motor Specifications ▶ p. 75 Driver Dimensions ▶ p. 76 Driver Specifications ▶ p. 77

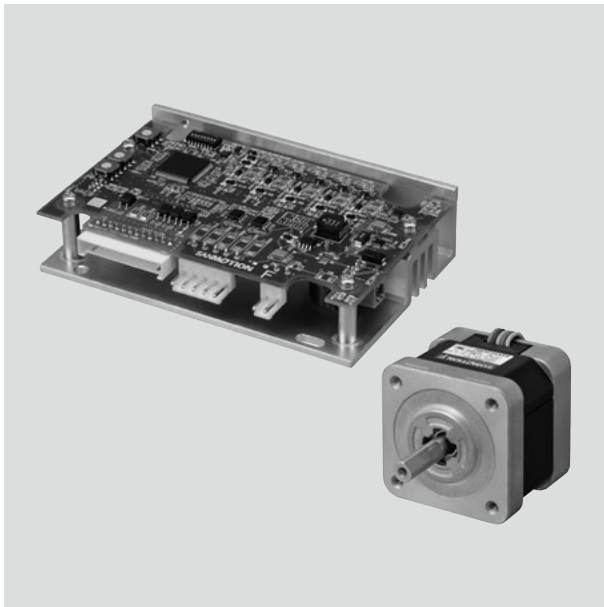

### Set configuration items RoHS

#### Driver CE c UL US RoHS

Model number: F5PAE140P100

Power supply: 24 VDC/48 V

- The operation manual can be downloaded from our website.
- Drivers are available for separate purchase.

#### Motor New pentagon connection

Motor size: 28 mm sq., 42 mm sq., 60 mm sq., 86 mm sq.

#### Cables with connector

For power supply, for I/O signals, and for motor (1 m each)

## System Configuration Diagram

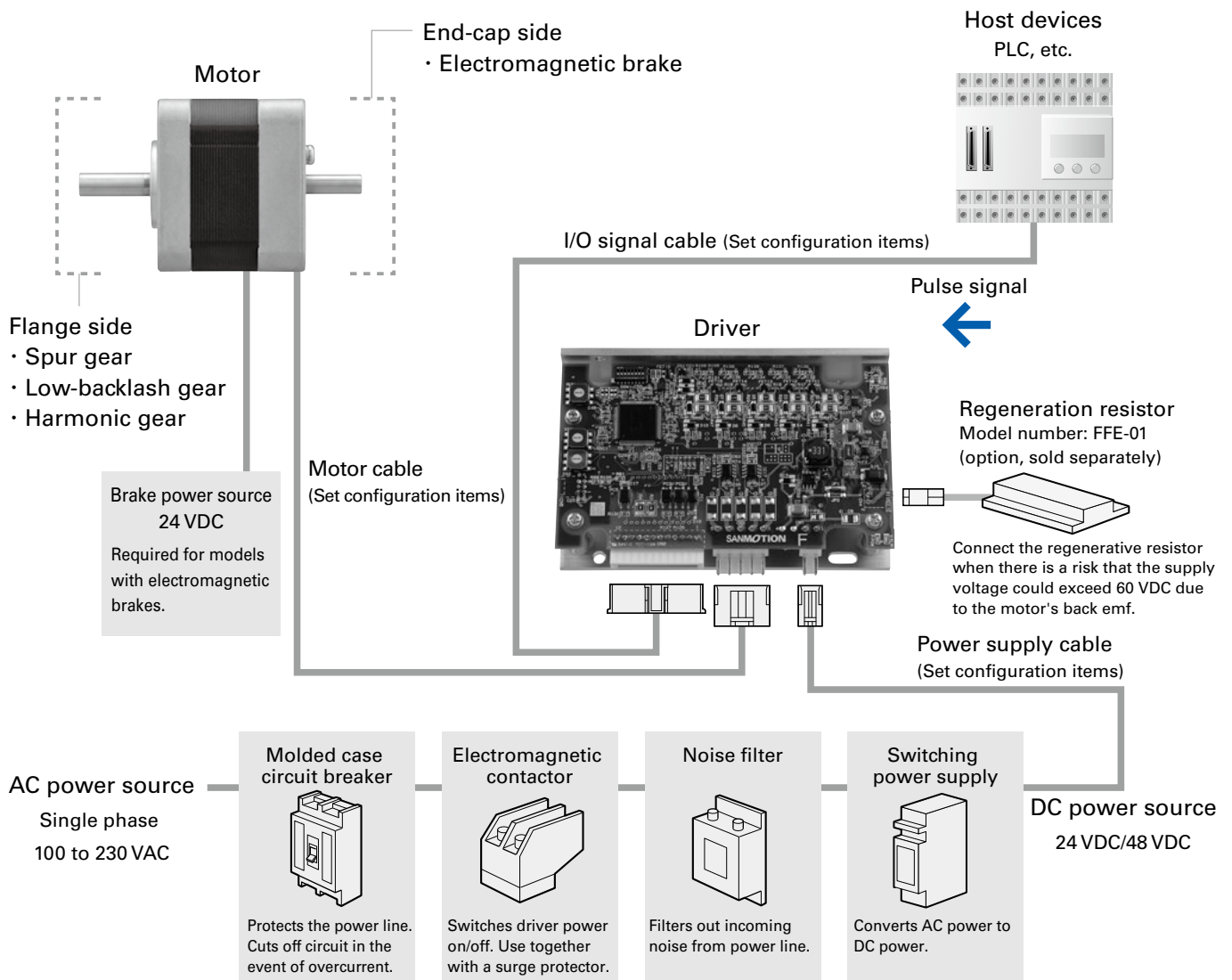

# Set Model Numbering Convention

Not every combination of the following codes or characters is available. Check the set model component details on the following page for the model number combinations, or contact us.

Example: This is a set model number for the DC input microstep driver and motor (model number: SM5601-82CXA41).

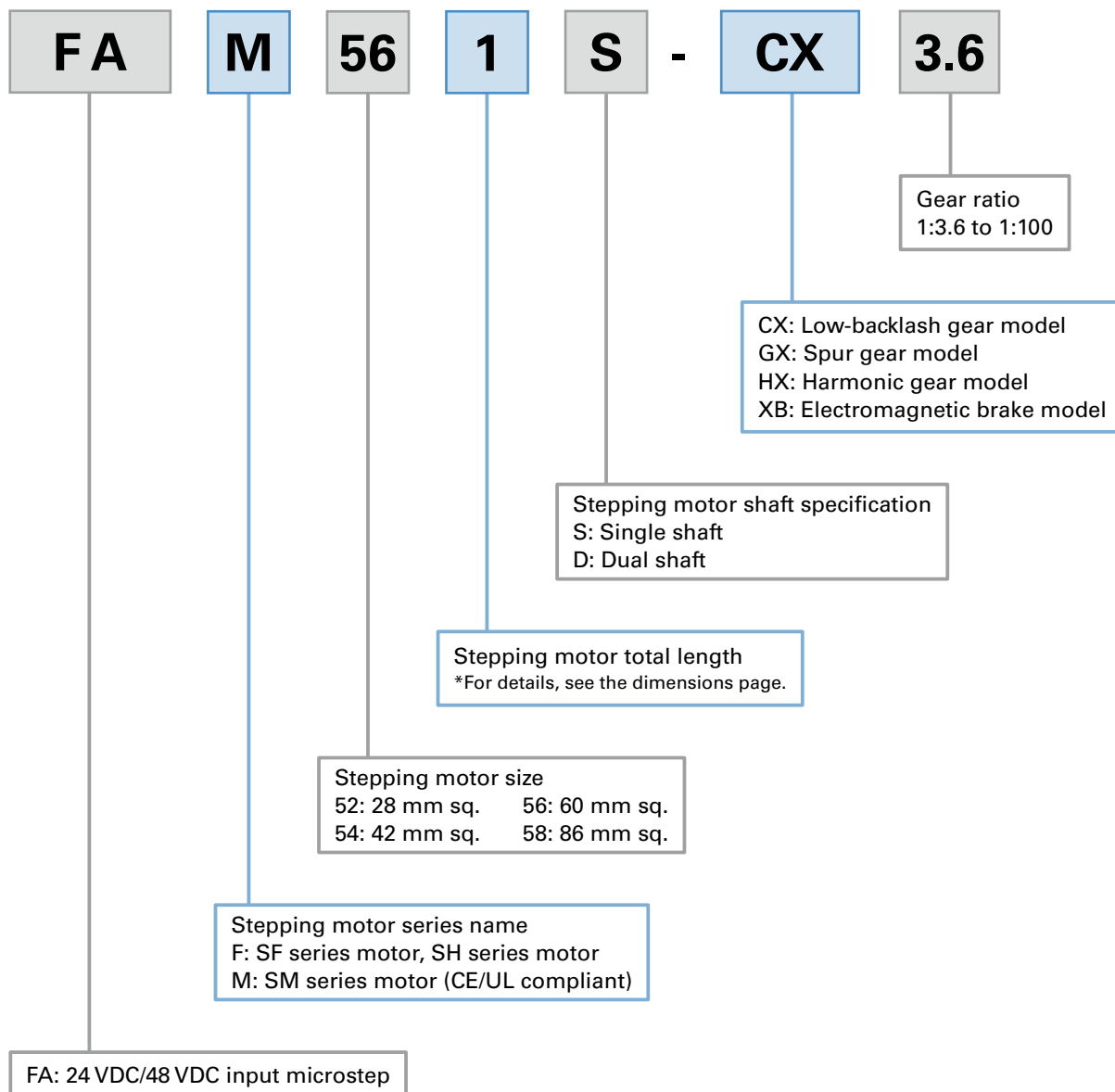

# Set Model Configuration

This set includes a driver, motor, and cable with connector.

DC input driver model number: F5PAE140P100

Basic step angle: 0.72°

Model	Motor size	Single shaft		Dual shaft		Rated current (A/phase)	Page		
		Set model number	Set configuration items	Set model number	Set configuration items		Specifi- cations	Dimen- sions	
			Motor		Motor				
Standard models	28 mm sq.	FAF521S	SH5281-7241	FAF521D	SH5281-7211	0.75	p. 56	p. 71	
		FAF525S	SH5285-7241	FAF525D	SH5285-7211		p. 56	p. 71	
	42 mm sq.	FAF541S	SF5421-8241	FAF541D	SF5421-8211	1.4	p. 56	p. 71	
		FAF542S	SF5422-8241	FAF542D	SF5422-8211		p. 56	p. 71	
		FAF543S	SF5423-8241	FAF543D	SF5423-8211		p. 57	p. 71	
	60 mm sq.	FAM561S	SM5601-8241	FAM561D	SM5601-8211	1.4	p. 57	p. 71	
		FAM562S	SM5602-8241	FAM562D	SM5602-8211		p. 57	p. 71	
		FAM563S	SM5603-8241	FAM563D	SM5603-8211		p. 57	p. 71	
	86 mm sq.	FAM581S	SM5861-8241	FAM581D	SM5861-8211	1.4	p. 58	p. 71	
		FAM582S	SM5862-8241	FAM582D	SM5862-8211		p. 58	p. 71	
	Low-backlash gear models	42 mm sq.	FAF541S-CX3.6	SF5421-82CXA41	FAF541D-CX3.6	SF5421-82CXA11	1.4	p. 59	p. 72
			FAF541S-CX7.2	SF5421-82CXB41	FAF541D-CX7.2	SF5421-82CXB11		p. 59	p. 72
FAF541S-CX10			SF5421-82CXE41	FAF541D-CX10	SF5421-82CXE11	p. 59		p. 72	
FAF541S-CX20			SF5421-82CXG41	FAF541D-CX20	SF5421-82CXG11	p. 59		p. 72	
FAF541S-CX30			SF5421-82CXJ41	FAF541D-CX30	SF5421-82CXJ11	p. 60		p. 72	
FAF541S-CX36			SF5421-82CXX41	FAF541D-CX36	SF5421-82CXX11	p. 60		p. 72	
60 mm sq.		FAM561S-CX3.6	SM5601-82CXA41	FAM561D-CX3.6	SM5601-82CXA11	1.4	p. 60	p. 72	
		FAM561S-CX7.2	SM5601-82CXB41	FAM561D-CX7.2	SM5601-82CXB11		p. 60	p. 72	
		FAM561S-CX10	SM5601-82CXE41	FAM561D-CX10	SM5601-82CXE11		p. 61	p. 72	
		FAM561S-CX20	SM5601-82CXG41	FAM561D-CX20	SM5601-82CXG11		p. 61	p. 72	
		FAM561S-CX30	SM5601-82CXJ41	FAM561D-CX30	SM5601-82CXJ11		p. 61	p. 72	
		FAM561S-CX36	SM5601-82CXX41	FAM561D-CX36	SM5601-82CXX11		p. 61	p. 72	
86 mm sq.		FAM581S-CX3.6	SM5861-82CXA41	FAM581D-CX3.6	SM5861-82CXA11	1.4	p. 62	p. 72	
		FAM581S-CX7.2	SM5861-82CXB41	FAM581D-CX7.2	SM5861-82CXB11		p. 62	p. 72	
		FAM581S-CX10	SM5861-82CXE41	FAM581D-CX10	SM5861-82CXE11		p. 62	p. 72	
		FAM581S-CX20	SM5861-82CXG41	FAM581D-CX20	SM5861-82CXG11		p. 62	p. 72	
		FAM581S-CX30	SM5861-82CXJ41	FAM581D-CX30	SM5861-82CXJ11		p. 63	p. 72	
		FAM581S-CX36	SM5861-82CXX41	FAM581D-CX36	SM5861-82CXX11		p. 63	p. 72	
Spur gear models		28 mm sq.	FAF521S-GX3.6	SH5281-72GXA4	FAF521D-GX3.6	SH5281-72GXA1	0.75	p. 64	p. 71
			FAF521S-GX7.2	SH5281-72GXB4	FAF521D-GX7.2	SH5281-72GXB1		p. 64	p. 71
			FAF521S-GX10	SH5281-72GXE4	FAF521D-GX10	SH5281-72GXE1		p. 64	p. 71
			FAF521S-GX20	SH5281-72GXG4	FAF521D-GX20	SH5281-72GXG1		p. 64	p. 71
			FAF521S-GX30	SH5281-72GXJ4	FAF521D-GX30	SH5281-72GXJ1		p. 65	p. 71
			FAF521S-GX50	SH5281-72GXL4	FAF521D-GX50	SH5281-72GXL1		p. 65	p. 71
Harmonic gear models	28 mm sq.	FAF521S-HX50	SH5281-72HXL4	FAF521D-HX50	SH5281-72HXL1	0.75	p. 66	p. 72	
		FAF521S-HX100	SH5281-72HXM4	FAF521D-HX100	SH5281-72HXM1		p. 66	p. 72	
	42 mm sq.	FAF541S-HX30	SF5421-82HXJ41	FAF541D-HX30	SF5421-82HXJ11	1.4	p. 66	p. 73	
		FAF541S-HX50	SF5421-82HXL41	FAF541D-HX50	SF5421-82HXL11		p. 66	p. 73	
		FAF541S-HX100	SF5421-82HXM41	FAF541D-HX100	SF5421-82HXM11		p. 67	p. 73	
	60 mm sq.	FAM561S-HX50	SM5601-82HXL41	FAM561D-HX50	SM5601-82HXL11	1.4	p. 67	p. 73	
		FAM561S-HX100	SM5601-82HXM41	FAM561D-HX100	SM5601-82HXM11		p. 67	p. 73	
	86 mm sq.	FAM581S-HX50	SM5861-82HXL41	FAM581D-HX50	SM5861-82HXL11	1.4	p. 67	p. 73	
		FAM581S-HX100	SM5861-82HXM41	FAM581D-HX100	SM5861-82HXM11		p. 68	p. 73	
	Electromagnetic brake models	42 mm sq.	FAF541S-XB	SF5421-82XB41	—	—	1.4	p. 69	p. 74
FAF542S-XB			SF5422-82XB41	—	—	p. 69		p. 74	
FAF543S-XB			SF5423-82XB41	—	—	p. 69		p. 74	
60 mm sq.		FAM561S-XB	SM5601-82XB41	—	—	1.4	p. 69	p. 74	
		FAM562S-XB	SM5602-82XB41	—	—		p. 70	p. 74	
		FAM563S-XB	SM5603-82XB41	—	—		p. 70	p. 74	
86 mm sq.		FAM581S-XB	SM5861-82XB41	—	—	1.4	p. 70	p. 74	
		FAM582S-XB	SM5862-82XB41	—	—		p. 70	p. 74	

\* The motors above are lead wire types.



● **Cables with connectors** Included in all DC input sets (Microstep)

**Power supply cable** (Model number: FC3P0010A)

Pin number	Color
1	White
2	Black

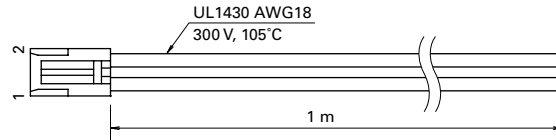

**Stepping motor extension cable** (Model number: FC3M0010A)

Pin number	Color
1	Blue
2	Red
3	Orange
4	Green
5	Black

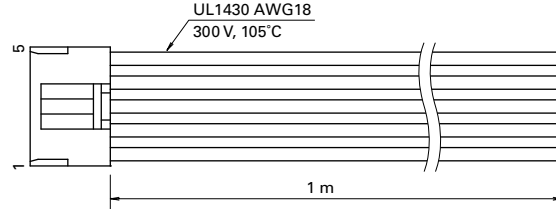

**I/O signal cable** (Model number: FC3S0010A)

Pin number	Color
1	
2	
3	
4	
5	Blue
6	
7	
8	
9	
10	
11	
12	

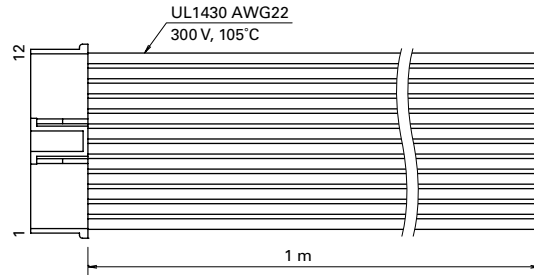

## Options (sold separately)

● **Regeneration resistor**

Use when main supply voltage could exceed 60 VDC.

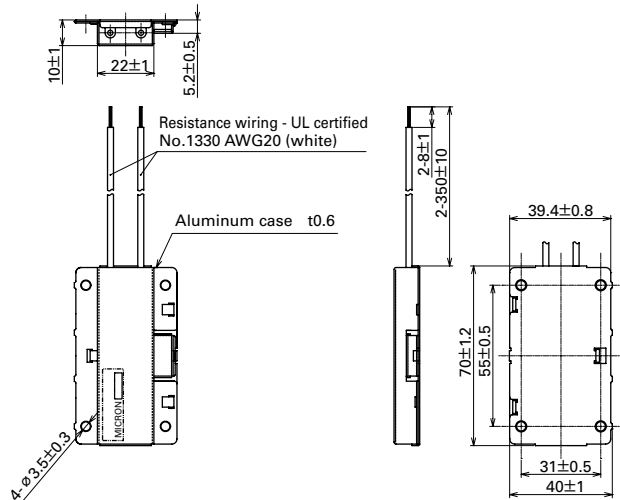

Model number	FFE-01
Rated power	60 W (with installed in aluminum heatsink 210 x 120 x t2)
Nominal resistance (Nominal standard resistance value)	20 Ω
Resistance value allowable tolerance	±5%
Insulation resistance	100 MΩ or over at 500 VDC megohm (between conductive part of cord and aluminum case)
Withstandable voltage	2000 VAC, for 1 minute (between conductive part of cord and aluminum case)
Instantaneous load tolerance	580 J [The amount of energy that resistor can consume for 1 minute (only once).]
Accessories	Connector model number: FK-MC0,5/2-ST2,5 (PHONENIX CONTACT GmbH & Co. KG) *For connecting the driver. Connect with screws.

## Standard model DC input Driver (Model number: F5PAE140P100) + Standard motor

RoHS

Basic step angle: 0.72° Rated current: 28 mm sq. Motor 0.75 A/phase, 42 mm sq. Motor 1.4 A/phase

Motor size		28 mm sq.		42 mm sq.	
Motor length		32 mm	51.5 mm	35 mm	41 mm
Single shaft	Set model number	<b>FAF521S</b>	<b>FAF525S</b>	<b>FAF541S</b>	<b>FAF542S</b>
	Configuration item: motor model number	SH5281-7241	SH5285-7241	SF5421-8241	SF5422-8241
Dual shaft	Set model number	<b>FAF521D</b>	<b>FAF525D</b>	<b>FAF541D</b>	<b>FAF542D</b>
	Configuration item: motor model number	SH5281-7211	SH5285-7211	SF5421-8211	SF5422-8211
Holding torque	N·m min.	0.041	0.078	0.125	0.185
Rotor inertia	×10 <sup>-4</sup> kg·m <sup>2</sup>	0.01	0.022	0.028	0.045
Motor mass *1	kg	0.11	0.2	0.24	0.31
Allowable thrust load	N	3	3	10	10
Allowable radial load *2	N	42	49	56	54

\*1 Driver mass ▶ p. 77

\*2 The load point is at the tip of the output shaft.

### Characteristics diagram

With rubber coupling

Pull-out torque ——— Source current (no load) - - - - - Source current (load applied) ······  
fs: Maximum self-start frequency when not loaded ●

#### FAF521S FAF521D

Winding current:  
0.75 A/phase

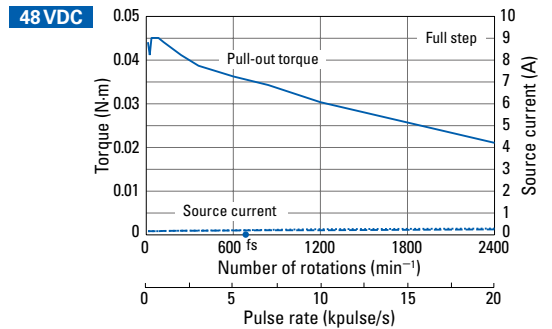
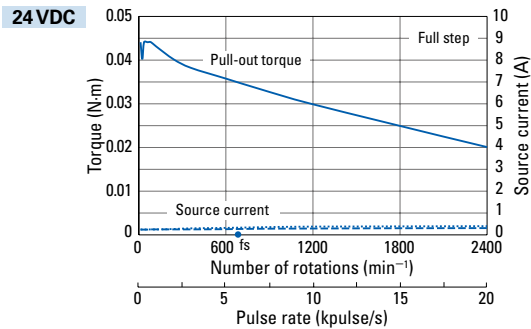

#### FAF525S FAF525D

Winding current:  
0.75 A/phase

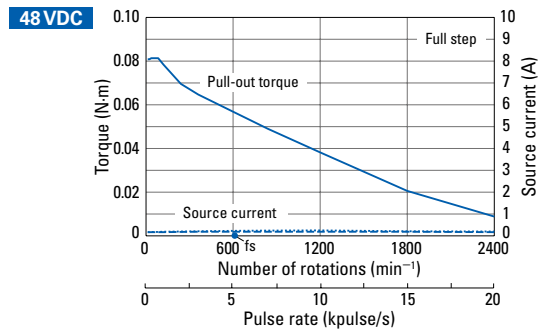
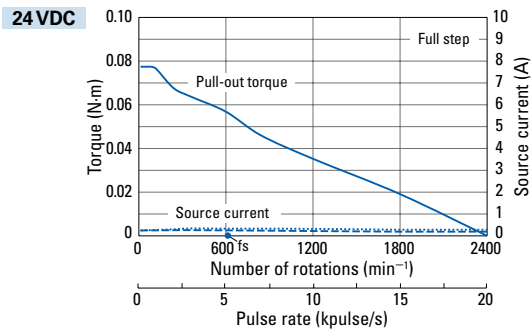

#### FAF541S FAF541D

Winding current:  
1.4 A/phase

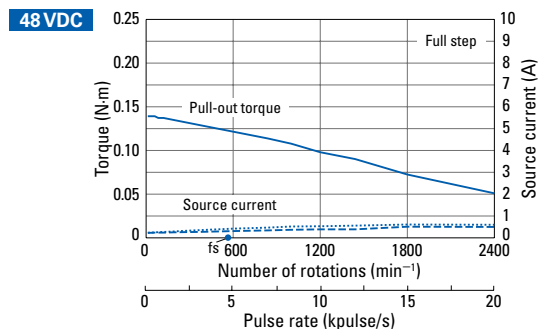
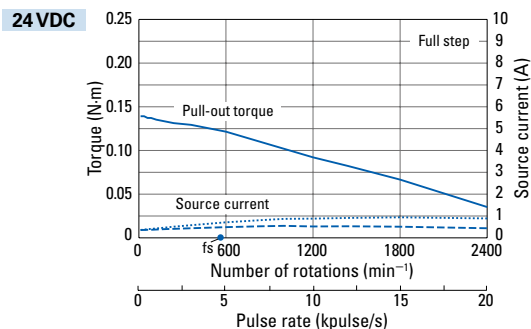

#### FAF542S FAF542D

Winding current:  
1.4 A/phase

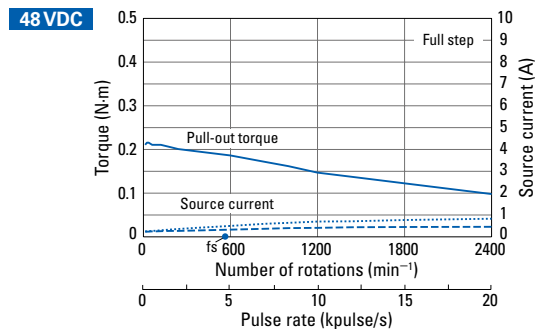
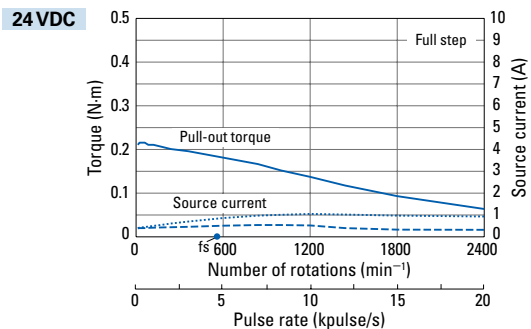

# Standard model

DC input Driver (Model number: F5PAE140P100) + Standard motor

RoHS

Basic step angle: 0.72° Rated current: 28 mm sq. Motor 0.75 A/phase, 42 mm sq. to 86 mm sq. Motor 1.4 A/phase

Motor size		42 mm sq.	60 mm sq.		
Motor length		49 mm	49 mm	60 mm	89 mm
Single shaft	Set model number	<b>FAF543S</b>	<b>FAM561S</b>	<b>FAM562S</b>	<b>FAM563S</b>
	Configuration item: motor model number	SF5423-8241	SM5601-8241	SM5602-8241	SM5603-8241
Dual shaft	Set model number	<b>FAF543D</b>	<b>FAM561D</b>	<b>FAM562D</b>	<b>FAM563D</b>
	Configuration item: motor model number	SF5423-8211	SM5601-8211	SM5602-8211	SM5603-8211
Holding torque	N·m min.	0.245	0.57	0.9	1.7
Rotor inertia	×10 <sup>-4</sup> kg·m <sup>2</sup>	0.056	0.2	0.31	0.6
Motor mass *1	kg	0.38	0.62	0.8	1.27
Allowable thrust load	N	10	20	20	20
Allowable radial load *2	N	52	191	183	170

\*1 Driver mass ▶ p. 77

\*2 The load point is at the tip of the output shaft.

## Characteristics diagram

Winding current: 1.4A/phase  
With rubber coupling

Pull-out torque ——— Source current (no load) - - - - -  
fs: Maximum self-start frequency when not loaded ●

Source current (load applied) ······

**FAF543S**  
**FAF543D**

**24 VDC**

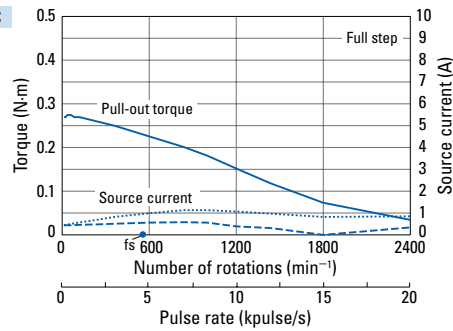

**48 VDC**

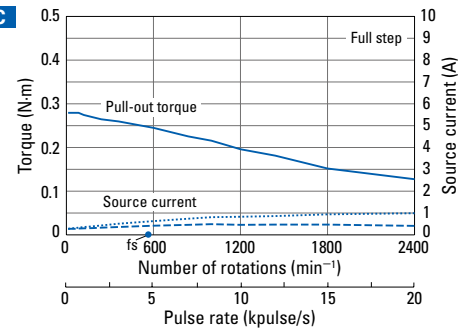

**FAM561S**  
**FAM561D**

**24 VDC**

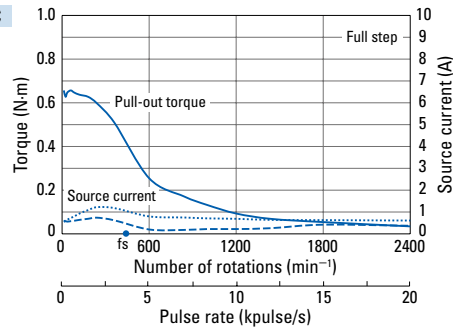

**48 VDC**

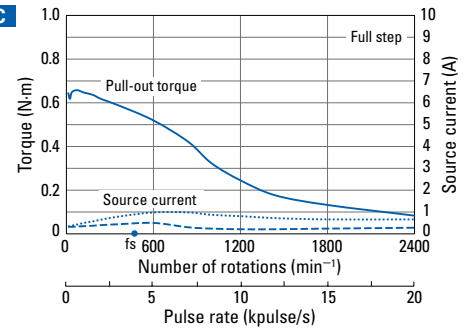

**FAM562S**  
**FAM562D**

**24 VDC**

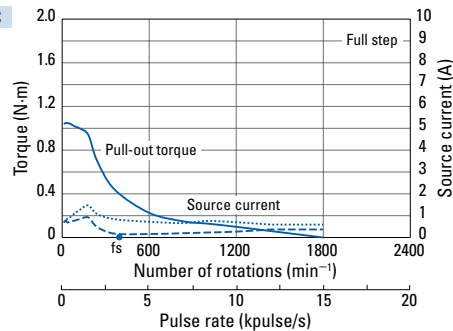

**48 VDC**

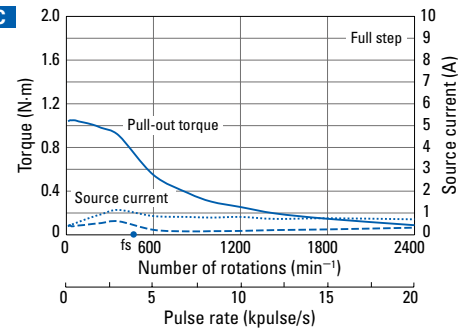

**FAM563S**  
**FAM563D**

**24 VDC**

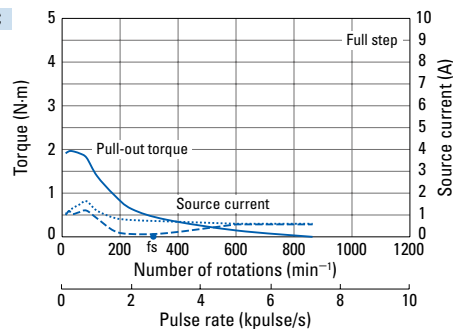

**48 VDC**

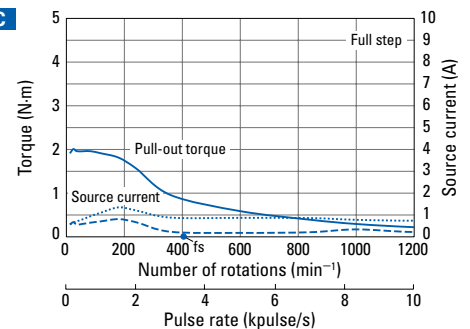

## Standard model DC input Driver (Model number: F5PAE140P100) + Standard motor

RoHS

Basic step angle: 0.72° Rated current: 28 mm sq. Motor 0.75 A/phase, 42 mm sq. to 86 mm sq. Motor 1.4 A/phase

Motor size		86 mm sq.	
Motor length		66 mm	96.5 mm
Single shaft	Set model number	FAM581S	FAM582S
	Configuration item: motor model number	SM5861-8241	SM5862-8241
Dual shaft	Set model number	FAM581D	FAM582D
	Configuration item: motor model number	SM5861-8211	SM5862-8211
Holding torque	N·m min.	2.3	4.4
Rotor inertia	$\times 10^{-4} \text{kg}\cdot\text{m}^2$	1.48	3
Motor mass *1	kg	1.75	2.9
Allowable thrust load	N	60	60
Allowable radial load *2	N	200	200

\*1 Driver mass ▶ p. 77

\*2 The load point is at the tip of the output shaft.

### Characteristics diagram

Winding current: 1.4A/phase  
With rubber coupling

Pull-out torque ——— Source current (no load) - - - - -  
fs: Maximum self-start frequency when not loaded ●

Source current (load applied) ······

**FAM581S**  
**FAM581D**

**24 VDC**

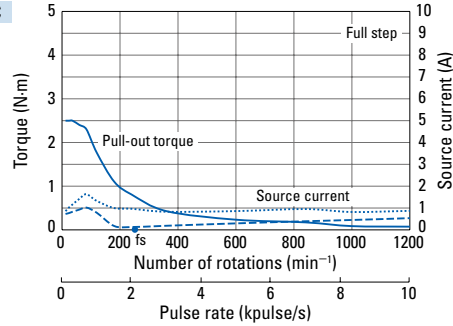

**48 VDC**

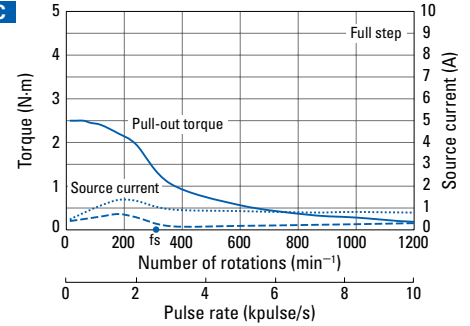

**FAM582S**  
**FAM582D**

**24 VDC**

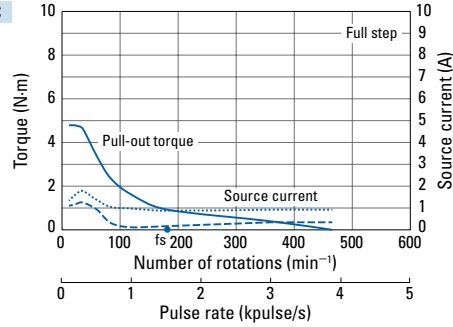

**48 VDC**

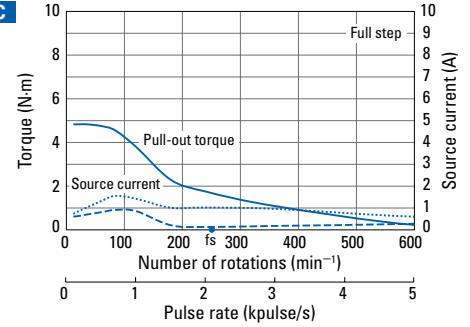

# Low-backlash gear model

DC input Driver (Model number: F5PAE140P100) + Motor with low-backlash gear

RoHS

Rated current: 1.4 A/phase

		42 mm sq. 65.4 mm			
		FAF541S-CX3.6 SF5421-82CXA41	FAF541S-CX7.2 SF5421-82CXB41	FAF541S-CX10 SF5421-82CXE41	FAF541S-CX20 SF5421-82CXG41
Motor size					
Motor + gear length					
Single shaft	Set model number Configuration item: motor model number	FAF541S-CX3.6 SF5421-82CXA41	FAF541S-CX7.2 SF5421-82CXB41	FAF541S-CX10 SF5421-82CXE41	FAF541S-CX20 SF5421-82CXG41
Dual shaft	Set model number Configuration item: motor model number	FAF541D-CX3.6 SF5421-82CXA11	FAF541D-CX7.2 SF5421-82CXB11	FAF541D-CX10 SF5421-82CXE11	FAF541D-CX20 SF5421-82CXG11
Allowable torque	N·m	0.343	0.686	1	1.5
Rotor inertia	$\times 10^{-4}$ kg·m <sup>2</sup>	0.028	0.028	0.028	0.028
Rated current	A/phase	1.4	1.4	1.4	1.4
Basic step angle	°	0.2	0.1	0.072	0.036
Gear ratio	—	1:3.6	1:7.2	1:10	1:20
Backlash	° or less	0.6	0.4	0.35	0.25
Allowable speed	min <sup>-1</sup>	500	250	180	90
Motor mass *1	kg	0.37	0.37	0.37	0.37
Allowable thrust load	N	15	15	15	15
Allowable radial load *2	N	20	20	20	20

Note: Directions of motor rotation and gear output shaft rotation are the same for models with reduction ratios 1:3.6, 1:7.2 and 1:10, and opposite for reduction ratios 1:20, 1:30, and 1:36.

\*1 Driver mass ▶ p. 77

\*2 When load is applied at 1/3 length from output shaft edge.

## Characteristics diagram

Winding current: 1.4A/phase

Allowable torque ——— Source current (no load) - - - - - Source current (load applied) ······  
fs: Maximum self-start frequency when not loaded ●

**FAF541S-CX3.6**  
**FAF541D-CX3.6**

**24 VDC**

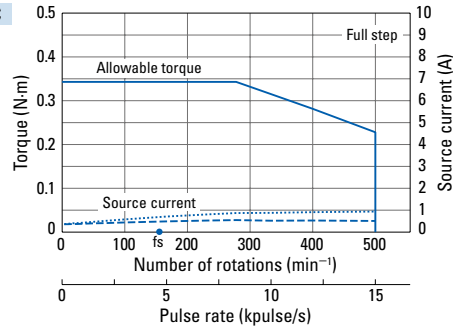

**48 VDC**

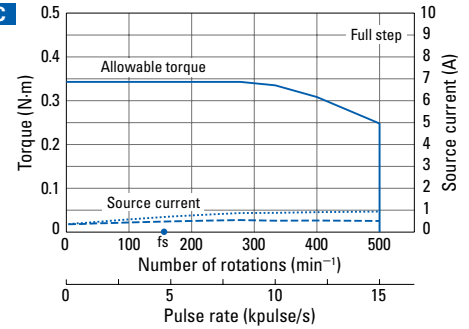

**FAF541S-CX7.2**  
**FAF541D-CX7.2**

**24 VDC**

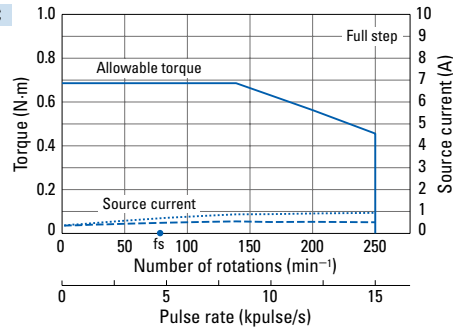

**48 VDC**

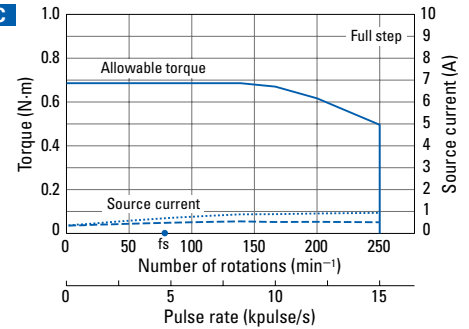

**FAF541S-CX10**  
**FAF541D-CX10**

**24 VDC**

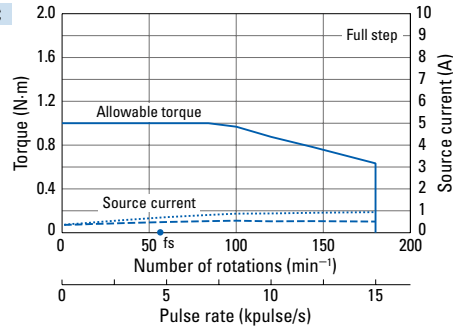

**48 VDC**

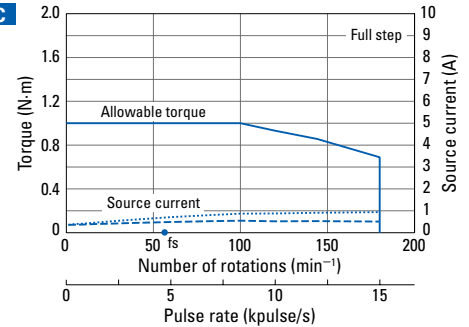

**FAF541S-CX20**  
**FAF541D-CX20**

**24 VDC**

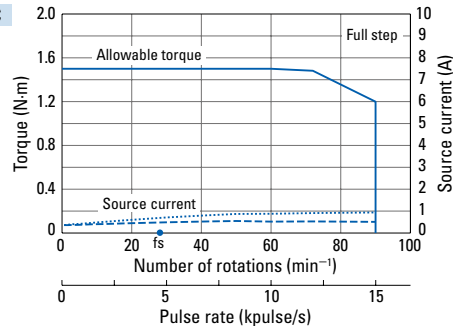

**48 VDC**

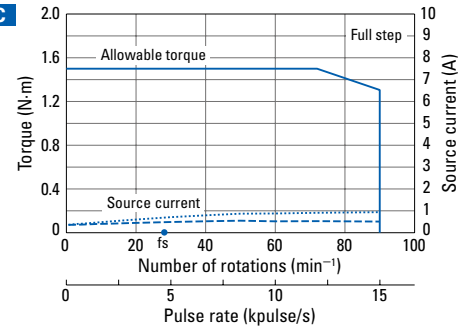

## Low-backlash gear model

DC input Driver (Model number: F5PAE140P100) + Motor with low-backlash gear

RoHS

Rated current: 1.4 A/phase

Motor size		42 mm sq. 65.4 mm		60 mm sq. 94.8 mm	
Motor + gear length					
Single shaft	Set model number Configuration item: motor model number	FAF541S-CX30 SF5421-82CXJ41	FAF541S-CX36 SF5421-82CXK41	FAM561S-CX3.6 SM5601-82CXA41	FAM561S-CX7.2 SM5601-82CXB41
Dual shaft	Set model number Configuration item: motor model number	FAF541D-CX30 SF5421-82CXJ11	FAF541D-CX36 SF5421-82CXK11	FAM561D-CX3.6 SM5601-82CXA11	FAM561D-CX7.2 SM5601-82CXB11
Allowable torque	N·m	1.5	1.5	1.25	2.5
Rotor inertia	$\times 10^{-4}$ kg·m <sup>2</sup>	0.028	0.028	0.2	0.2
Rated current	A/phase	1.4	1.4	1.4	1.4
Basic step angle	°	0.024	0.02	0.2	0.1
Gear ratio	—	1:30	1:36	1:3.6	1:7.2
Backlash	° or less	0.25	0.25	0.55	0.25
Allowable speed	min <sup>-1</sup>	60	50	500	250
Motor mass *1	kg	0.37	0.37	1	1
Allowable thrust load	N	15	15	30	30
Allowable radial load *2	N	20	20	100	100

Note: Directions of motor and gear output shaft rotation for 42 mm sq. models are the same for models with reduction ratios 1:3.6, 1:7.2 and 1:10, and opposite for reduction ratios 1:20, 1:30 and 1:36. For 60 mm sq. models, rotation directions are the same for models with reduction ratios 1:3.6 and 1:7.2, and opposite for reduction ratios 1:10, 1:20, 1:30 and 1:36.

\*1 Driver mass ▶ p. 77

\*2 When load is applied at 1/3 length from output shaft edge.

### Characteristics diagram

Winding current: 1.4A/phase

Allowable torque ——— Source current (no load) - - - - - Source current (load applied) ······  
fs: Maximum self-start frequency when not loaded ●

**FAF541S-CX30**  
**FAF541D-CX30**

**24 VDC**

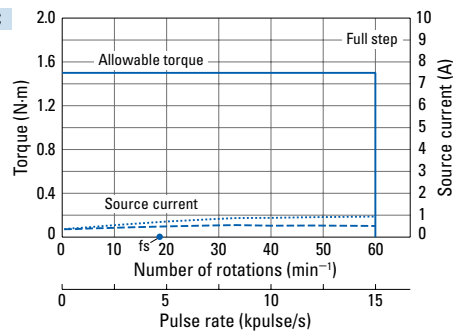

**48 VDC**

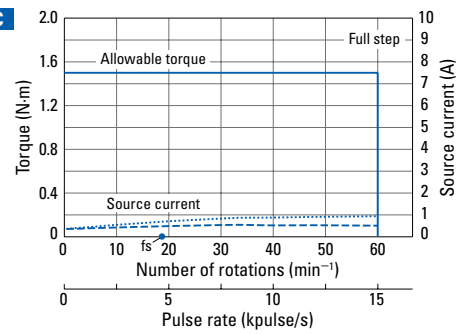

**FAF541S-CX36**  
**FAF541D-CX36**

**24 VDC**

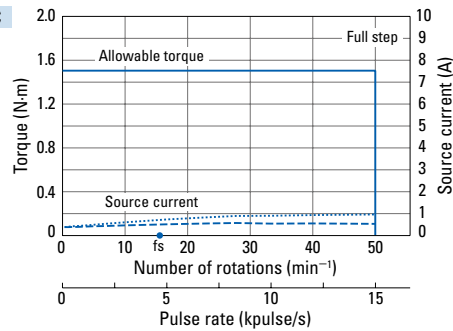

**48 VDC**

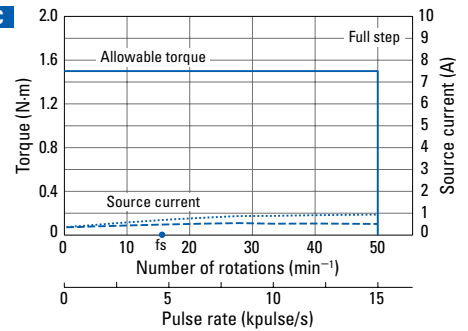

**FAM561S-CX3.6**  
**FAM561D-CX3.6**

**24 VDC**

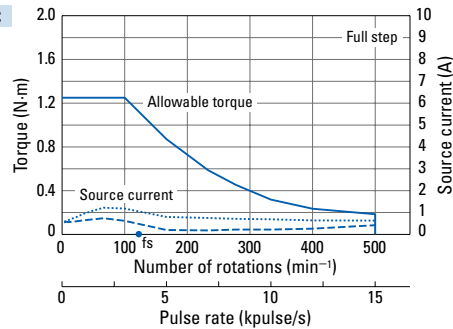

**48 VDC**

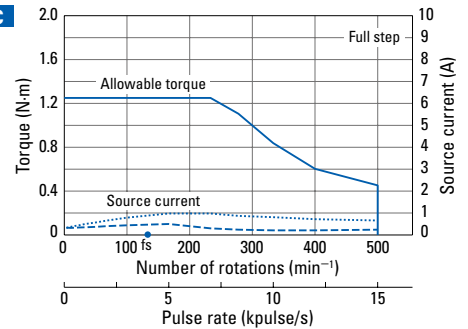

**FAM561S-CX7.2**  
**FAM561D-CX7.2**

**24 VDC**

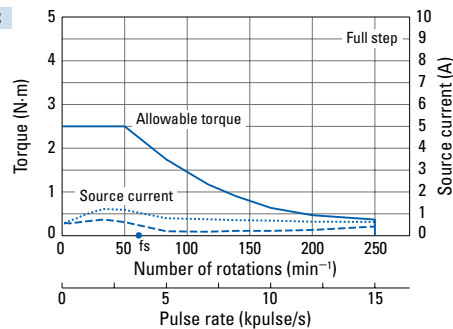

**48 VDC**

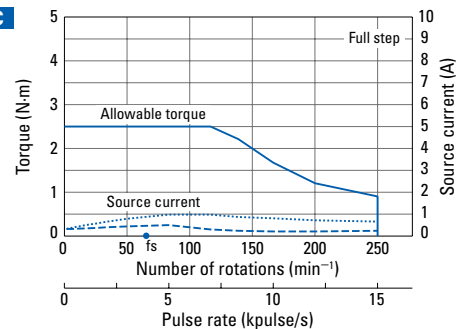

# Low-backlash gear model

DC input Driver (Model number: F5PAE140P100) + Motor with low-backlash gear

RoHS

Rated current: 1.4 A/phase

		60 mm sq. 94.8 mm			
		FAM561S-CX10 SM5601-82CXE41	FAM561S-CX20 SM5601-82CXG41	FAM561S-CX30 SM5601-82CXJ41	FAM561S-CX36 SM5601-82CXX41
Motor size		60 mm sq. 94.8 mm			
Motor + gear length					
Single shaft	Set model number Configuration item: motor model number	FAM561S-CX10 SM5601-82CXE41	FAM561S-CX20 SM5601-82CXG41	FAM561S-CX30 SM5601-82CXJ41	FAM561S-CX36 SM5601-82CXX41
Dual shaft	Set model number Configuration item: motor model number	FAM561D-CX10 SM5601-82CXE11	FAM561D-CX20 SM5601-82CXG11	FAM561D-CX30 SM5601-82CXJ11	FAM561D-CX36 SM5601-82CXX11
Allowable torque	N·m	3	3.5	4	4
Rotor inertia	$\times 10^{-4}$ kg·m <sup>2</sup>	0.2	0.2	0.2	0.2
Rated current	A/phase	1.4	1.4	1.4	1.4
Basic step angle	°	0.072	0.036	0.024	0.02
Gear ratio	—	1:10	1:20	1:30	1:36
Backlash	° or less	0.25	0.17	0.17	0.17
Allowable speed	min <sup>-1</sup>	180	90	60	50
Motor mass *1	kg	1	1	1	1
Allowable thrust load	N	30	30	30	30
Allowable radial load *2	N	100	100	100	100

Note: Directions of motor rotation and gear output shaft rotation are the same for models with reduction ratios 1:3.6 and 1:7.2, and opposite for reduction ratios 1:10, 1:20, 1:30 and 1:36.

\*1 Driver mass ▶ p. 77

\*2 When load is applied at 1/3 length from output shaft edge.

## Characteristics diagram

Winding current: 1.4A/phase

Allowable torque ——— Source current (no load) - - - - - Source current (load applied) ······  
fs: Maximum self-start frequency when not loaded ●

**FAM561S-CX10**  
**FAM561D-CX10**

**24 VDC**

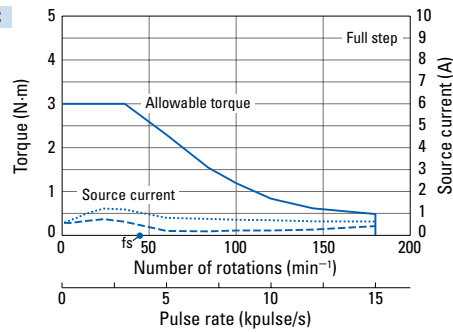

**48 VDC**

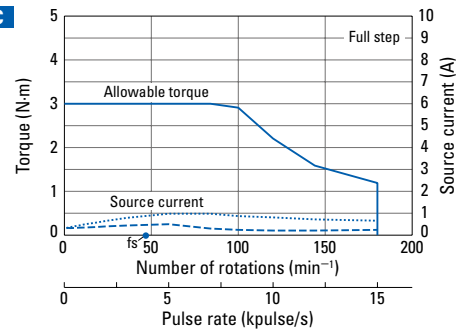

**FAM561S-CX20**  
**FAM561D-CX20**

**24 VDC**

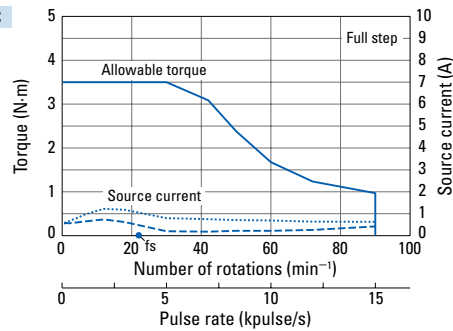

**48 VDC**

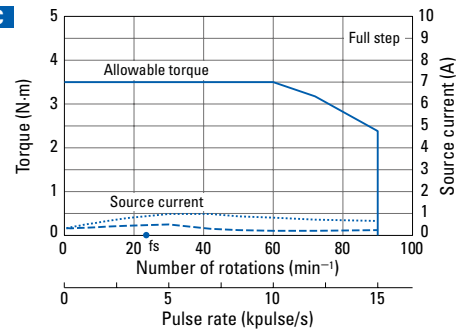

**FAM561S-CX30**  
**FAM561D-CX30**

**24 VDC**

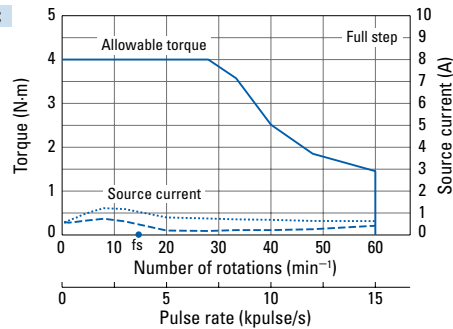

**48 VDC**

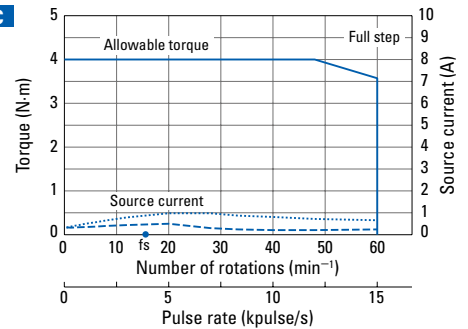

**FAM561S-CX36**  
**FAM561D-CX36**

**24 VDC**

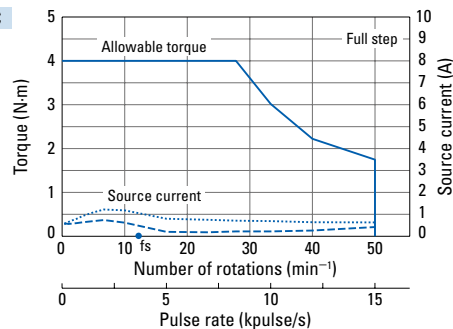

**48 VDC**

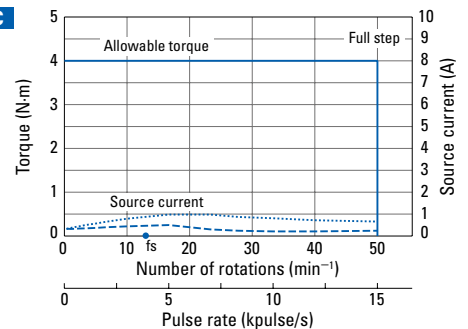



Low-backlash gear model

DC input Driver (Model number: F5PAE140P100) + Motor with low-backlash gear

RoHS

Rated current: 1.4 A/phase

		86 mm sq. (angular dimension 90 mm sq.)			
		131 mm			
Motor size	Motor + gear length	FAM581S-CX3.6 SM5861-82CXA41	FAM581S-CX7.2 SM5861-82CXB41	FAM581S-CX10 SM5861-82CXE41	FAM581S-CX20 SM5861-82CXG41
Single shaft	Set model number Configuration item: motor model number	FAM581D-CX3.6 SM5861-82CXA11	FAM581D-CX7.2 SM5861-82CXB11	FAM581D-CX10 SM5861-82CXE11	FAM581D-CX20 SM5861-82CXG11
Dual shaft	Set model number Configuration item: motor model number				
Allowable torque	N·m	4.5	9	9	12
Rotor inertia	$\times 10^{-4}$ kg·m <sup>2</sup>	1.48	1.48	1.48	1.48
Rated current	A/phase	1.4	1.4	1.4	1.4
Basic step angle	°	0.2	0.1	0.072	0.036
Gear ratio	—	1:3.6	1:7.2	1:10	1:20
Backlash	° or less	0.35	0.22	0.22	0.15
Allowable speed	min <sup>-1</sup>	500	250	180	90
Motor mass *1	kg	2.95	2.95	2.95	2.95
Allowable thrust load	N	60	60	60	60
Allowable radial load *2	N	300	300	300	300

Note: Directions of motor rotation and gear output shaft rotation are the same for models with reduction ratios 1:3.6 and 1:7.2, and opposite for reduction ratios 1:10, 1:20, 1:30 and 1:36.

\*1 Driver mass ▶ p. 77

\*2 When load is applied at 1/3 length from output shaft edge.

Characteristics diagram

Winding current: 1.4A/phase

Allowable torque ——— Source current (no load) - - - - - Source current (load applied) ······  
fs: Maximum self-start frequency when not loaded ●

FAM581S-CX3.6  
FAM581D-CX3.6

24 VDC

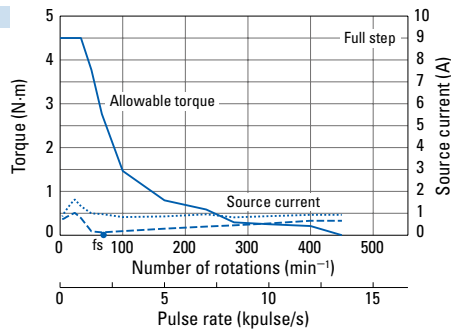

48 VDC

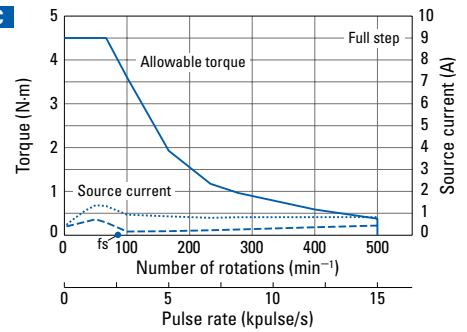

FAM581S-CX7.2  
FAM581D-CX7.2

24 VDC

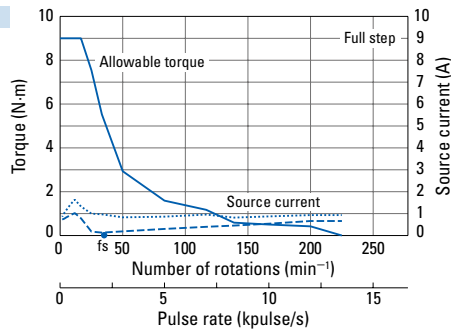

48 VDC

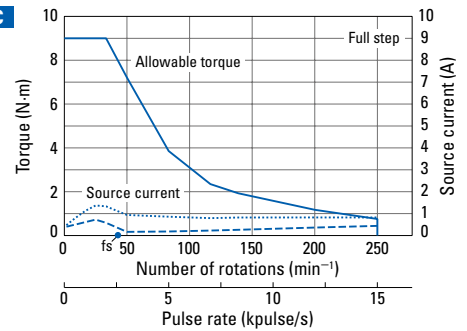

FAM581S-CX10  
FAM581D-CX10

24 VDC

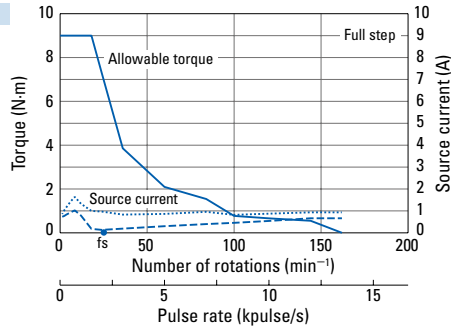

48 VDC

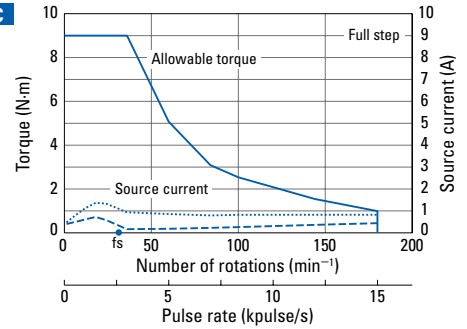

FAM581S-CX20  
FAM581D-CX20

24 VDC

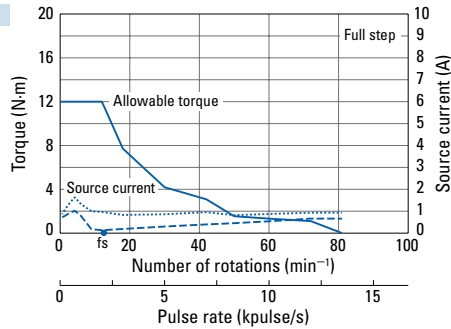

48 VDC

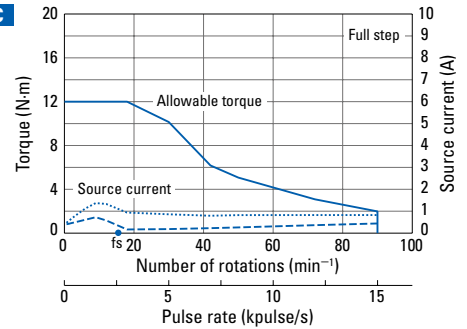

# Low-backlash gear model

DC input Driver (Model number: F5PAE140P100) + Motor with low-backlash gear

RoHS

Rated current: 1.4 A/phase

Motor size		86 mm sq. (angular dimension 90 mm sq.)	
Motor + gear length		131 mm	
Single shaft	Set model number Configuration item: motor model number	FAM581S-CX30 SM5861-82CXJ41	FAM581S-CX36 SM5861-82CXK41
Dual shaft	Set model number Configuration item: motor model number	FAM581D-CX30 SM5861-82CXJ11	FAM581D-CX36 SM5861-82CXK11
Allowable torque	N·m	12	12
Rotor inertia	$\times 10^{-4}$ kg·m <sup>2</sup>	1.48	1.48
Rated current	A/phase	1.4	1.4
Basic step angle	°	0.024	0.02
Gear ratio	—	1:30	1:36
Backlash	° or less	0.15	0.13
Allowable speed	min <sup>-1</sup>	60	50
Motor mass *1	kg	2.95	2.95
Allowable thrust load	N	60	60
Allowable radial load *2	N	300	300

Note: Directions of motor rotation and gear output shaft rotation are the same for models with reduction ratios 1:3.6 and 1:7.2, and opposite for reduction ratios 1:10, 1:20, 1:30 and 1:36.

\*1 Driver mass ▶ p. 77

\*2 When load is applied at 1/3 length from output shaft edge.

## Characteristics diagram

Winding current: 1.4A/phase

Allowable torque ——— Source current (no load) - - - - - Source current (load applied) ······  
fs: Maximum self-start frequency when not loaded ●

**FAM581S-CX30**  
**FAM581D-CX30**

**24 VDC**

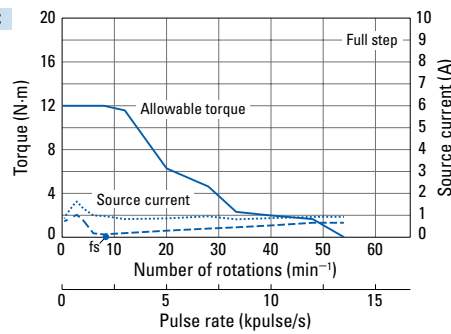

**48 VDC**

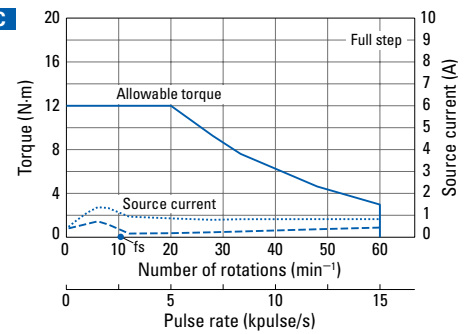

**FAM581S-CX36**  
**FAM581D-CX36**

**24 VDC**

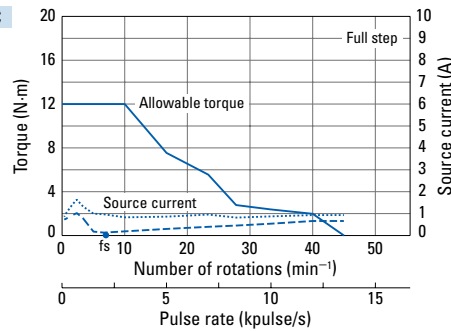

**48 VDC**

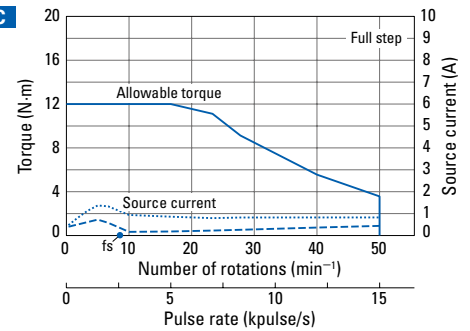

## Spur gear model DC input Driver (Model number: F5PAE140P100) + Motor with spur gear

RoHS

Rated current: 0.75 A/phase

Motor size		28 mm sq. 61.5 mm			
Motor + gear length					
Single shaft	Set model number Configuration item: motor model number	FAF521S-GX3.6 SH5281-72GXA4	FAF521S-GX7.2 SH5281-72GXB4	FAF521S-GX10 SH5281-72GXE4	FAF521S-GX20 SH5281-72GXG4
Dual shaft	Set model number Configuration item: motor model number	FAF521D-GX3.6 SH5281-72GXA1	FAF521D-GX7.2 SH5281-72GXB1	FAF521D-GX10 SH5281-72GXE1	FAF521D-GX20 SH5281-72GXG1
Allowable torque	N·m	0.1	0.15	0.2	0.35
Rotor inertia	$\times 10^{-4}$ kg·m <sup>2</sup>	0.01	0.01	0.01	0.01
Rated current	A/phase	0.75	0.75	0.75	0.75
Basic step angle	°	0.2	0.1	0.072	0.036
Gear ratio	—	1:3.6	1:7.2	1:10	1:20
Backlash	° or less	2	2	2	1.5
Allowable speed	min <sup>-1</sup>	800	400	300	150
Motor mass *1	kg	0.17	0.17	0.17	0.17
Allowable thrust load	N	10	10	10	10
Allowable radial load *2	N	15	15	15	15

Note: Directions of motor rotation and gear output shaft rotation are the same for models with reduction ratios 1:3.6, 1:7.2, 1:20, 1:30 and 1:50, and opposite for reduction ratios 1:10.

\*1 Driver mass ▶ p. 77

\*2 When load is applied at 1/3 length from output shaft edge.

### Characteristics diagram

Winding current: 0.75A/phase

Allowable torque ——— Source current (no load) - - - - - Source current (load applied) ······  
fs: Maximum self-start frequency when not loaded ●

**FAF521S-GX3.6**  
**FAF521D-GX3.6**

**24 VDC**

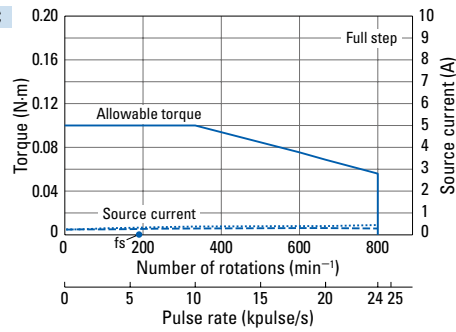

**48 VDC**

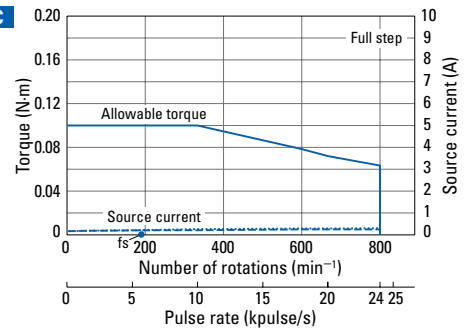

**FAF521S-GX7.2**  
**FAF521D-GX7.2**

**24 VDC**

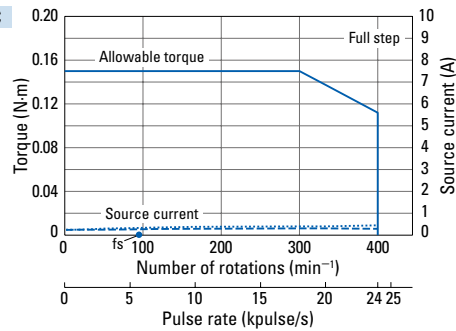

**48 VDC**

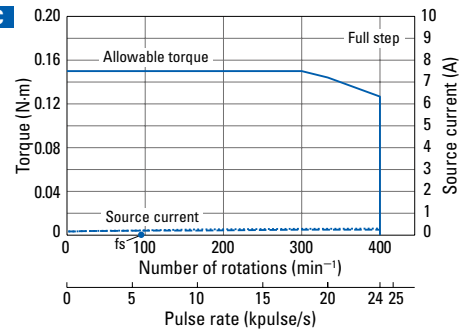

**FAF521S-GX10**  
**FAF521D-GX10**

**24 VDC**

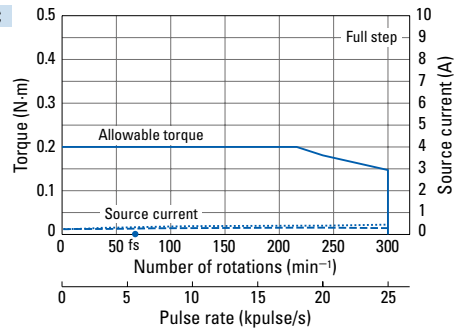

**48 VDC**

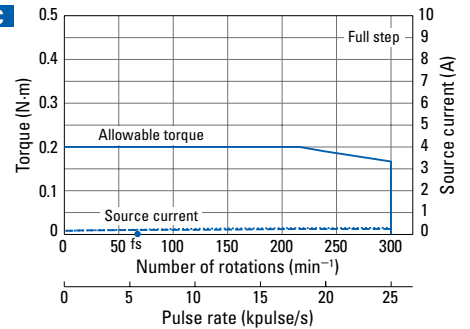

**FAF521S-GX20**  
**FAF521D-GX20**

**24 VDC**

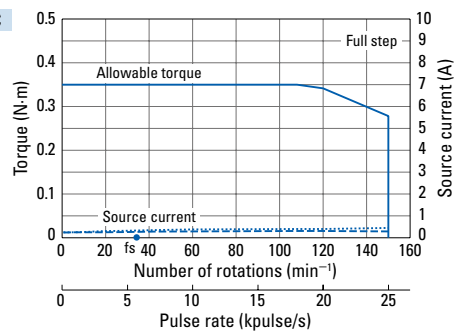

**48 VDC**

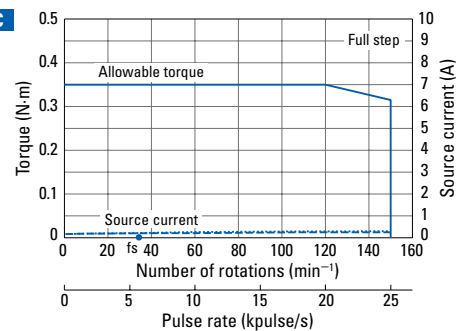

# Spur gear model

DC input Driver (Model number: F5PAE140P100) + Motor with spur gear

RoHS

Rated current: 0.75 A/phase

Motor size		28 mm sq.	
Motor + gear length		61.5 mm	
Single shaft	Set model number Configuration item: motor model number	FAF521S-GX30 SH5281-72GXJ4	FAF521S-GX50 SH5281-72GXL4
Dual shaft	Set model number Configuration item: motor model number	FAF521D-GX30 SH5281-72GXJ1	FAF521D-GX50 SH5281-72GXL1
Allowable torque	N·m	0.5	0.5
Rotor inertia	$\times 10^{-4}$ kg·m <sup>2</sup>	0.01	0.01
Rated current	A/phase	0.75	0.75
Basic step angle	°	0.024	0.0144
Gear ratio	—	1:30	1:50
Backlash	° or less	1.5	1.5
Allowable speed	min <sup>-1</sup>	100	60
Motor mass *1	kg	0.17	0.17
Allowable thrust load	N	10	10
Allowable radial load *2	N	15	15

Note: Directions of motor rotation and gear output shaft rotation are the same for models with reduction ratios 1:3.6, 1:7.2, 1:20, 1:30 and 1:50, and opposite for reduction ratios 1:10.

\*1 Driver mass ▶ p. 77

\*2 When load is applied at 1/3 length from output shaft edge.

## Characteristics diagram

Winding current: 0.75A/phase

Allowable torque ——— Source current (no load) - - - - - Source current (load applied) ······  
fs: Maximum self-start frequency when not loaded ●

**FAF521S-GX30**  
**FAF521D-GX30**

**24 VDC**

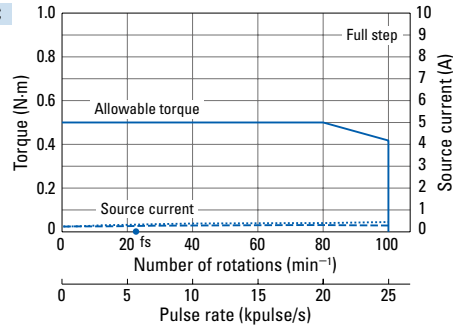

**48 VDC**

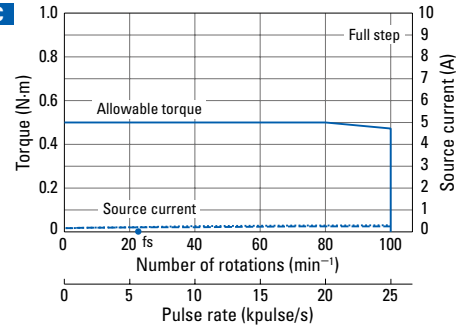

**FAF521S-GX50**  
**FAF521D-GX50**

**24 VDC**

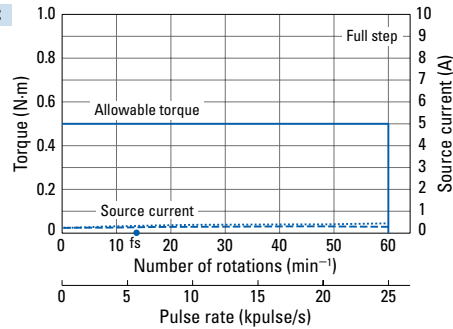

**48 VDC**

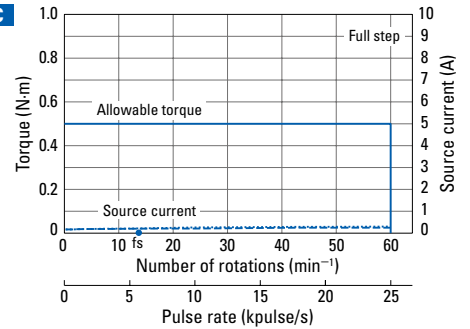

## Harmonic gear model

DC input Driver (Model number: F5PAE140P100) + Motor with harmonic gear

RoHS

Rated current: 28 mm sq. Motor 0.75 A/phase, 42 mm sq. to 86 mm sq. Motor 1.4 A/phase

Motor size		28 mm sq. (angular dimension 33 mm sq.)	42 mm sq.
Motor + gear length		70.7 mm	74.4 mm
Single shaft	Set model number Configuration item: motor model number	FAF521S-HX50 SH5281-72HXL4	FAF521S-HX100 SH5281-72HXM4
Dual shaft	Set model number Configuration item: motor model number	FAF521D-HX50 SH5281-72HXL1	FAF521D-HX100 SH5281-72HXM1
Allowable torque	N·m	1.5	2
Momentary allowable torque	N·m	2.6	3.6
Rotor inertia	$\times 10^{-4}$ kg·m <sup>2</sup>	0.013	0.013
Rated current	A/phase	0.75	0.75
Basic step angle	°	0.0144	0.0072
Gear ratio	—	1:50	1:100
Hysteresis loss	Arc min or less	-	-
Lost motion	Arc min	0.4 to 3 ( $\pm 0.06$ N·m)	0.4 to 3 ( $\pm 0.08$ N·m)
Allowable speed	min <sup>-1</sup>	70	35
Motor mass *1	kg	0.22	0.22
Allowable thrust load	N	100	100
Allowable radial load *2	N	160	160

Note: The motor and gear output shaft rotate in the opposite direction.

\*1 Driver mass ▶ p. 77

\*2 When load is applied at 1/3 length from output shaft edge.

## Characteristics diagram

Momentary allowable torque --- Source current (no load) --- fs: Maximum self-start frequency when not loaded ●  
 Allowable torque — Source current (load applied) ---

### FAF521S-HX50 FAF521D-HX50

Winding current:  
0.75 A/phase

24 VDC

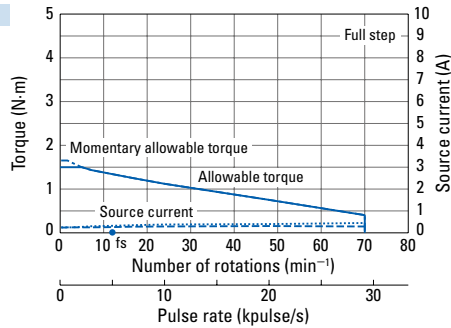

48 VDC

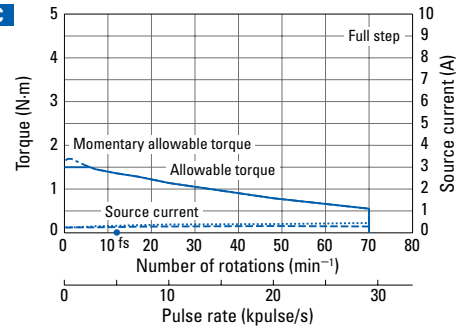

### FAF521S-HX100 FAF521D-HX100

Winding current:  
0.75 A/phase

24 VDC

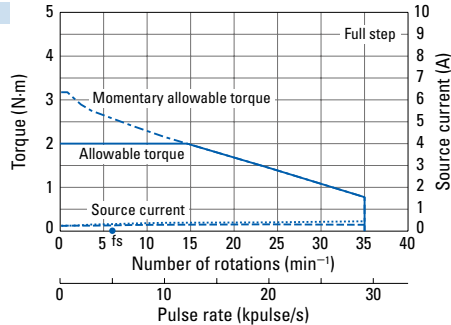

48 VDC

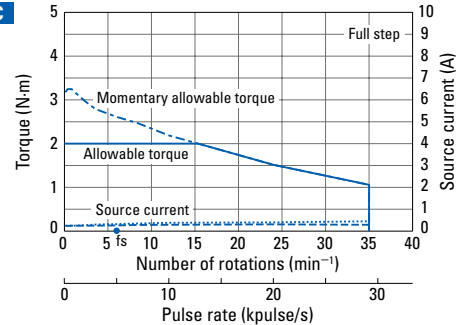

### FAF541S-HX30 FAF541D-HX30

Winding current:  
1.4 A/phase

24 VDC

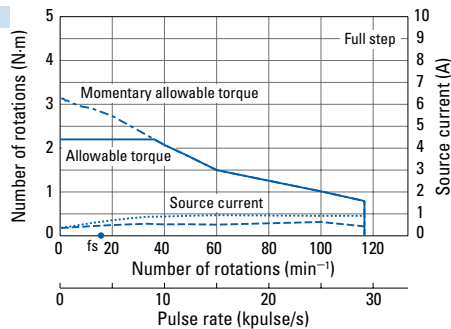

48 VDC

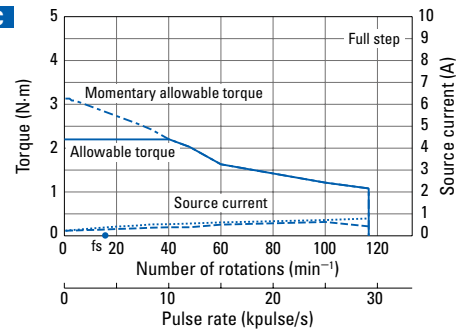

### FAF541S-HX50 FAF541D-HX50

Winding current:  
1.4 A/phase

24 VDC

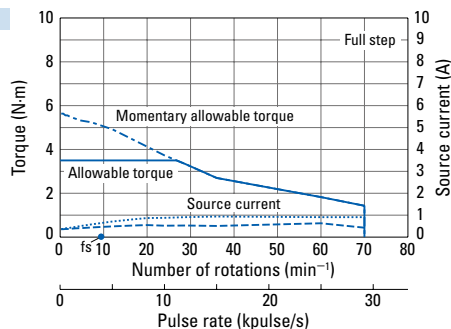

48 VDC

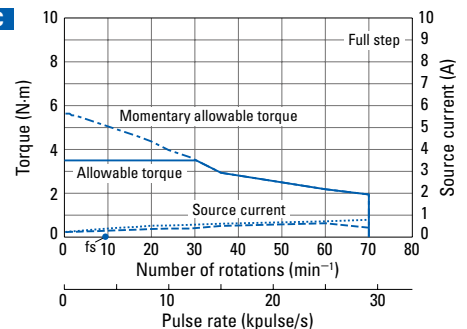

System Configuration Diagram ▶ p. 52 Set Model Configuration ▶ p. 54 Motor Dimensions ▶ pp. 71 to 74 Driver Dimensions ▶ p. 76

If allowable instantaneous torque is exceeded when using a motor with harmonic gears, the gears may be damaged. When selecting a motor, ensure that its allowable instantaneous torque will not be exceeded. Data is measured under the trial conditions of SANYO DENKI. Driving torque may vary according to actual machine precision.

# Harmonic gear model

DC input Driver (Model number: F5PAE140P100) + Motor with harmonic gear

RoHS

Rated current: 28 mm sq. Motor 0.75 A/phase, 42 mm sq. to 86 mm sq. Motor 1.4 A/phase

Motor size		42 mm sq.	60 mm sq.		86 mm sq. (angular dimension 90 mm sq.)
Motor + gear length		74.4 mm	116.3 mm		148 mm
Single shaft	Set model number	<b>FAF541S-HX100</b>	<b>FAM561S-HX50</b>	<b>FAM561S-HX100</b>	<b>FAM581S-HX50</b>
	Configuration item: motor model number	SF5421-82HXM41	SM5601-82HXL41	SM5601-82HXM41	SM5861-82HXL41
Dual shaft	Set model number	<b>FAF541D-HX100</b>	<b>FAM561D-HX50</b>	<b>FAM561D-HX100</b>	<b>FAM581D-HX50</b>
	Configuration item: motor model number	SF5421-82HXM11	SM5601-82HXL11	SM5601-82HXM11	SM5861-82HXL11
Allowable torque	N·m	5	5.5	8	25
Momentary allowable torque	N·m	11	14	20	34
Rotor inertia	$\times 10^{-4}$ kg·m <sup>2</sup>	0.04	0.23	0.23	1.68
Rated current	A/phase	1.4	1.4	1.4	1.4
Basic step angle	°	0.0072	0.0144	0.0072	0.0144
Gear ratio	—	1:100	1:50	1:100	1:50
Hysteresis loss	Arc min or less	2.4	-	-	-
Lost motion	Arc min	-	0.4 to 3 ( $\pm 0.28$ N·m)	0.4 to 1.5 ( $\pm 0.4$ N·m)	0.4 to 3 ( $\pm 1$ N·m)
Allowable speed	min <sup>-1</sup>	35	70	35	70
Motor mass *1	kg	0.44	1.22	1.22	1.22
Allowable thrust load	N	1150	400	400	1400
Allowable radial load *2	N	275	360	360	1600

Note: The motor and gear output shaft rotate in the opposite direction.

\*1 Driver mass ▶ p. 77

\*2 When load is applied at 1/3 length from output shaft edge.

## Characteristics diagram

Winding current: 1.4A/phase

Momentary allowable torque ———— Source current (no load) - - - - - fs: Maximum self-start frequency when not loaded  
 Allowable torque ———— Source current (load applied) ······

**FAF541S-HX100**  
**FAF541D-HX100**

**24 VDC**

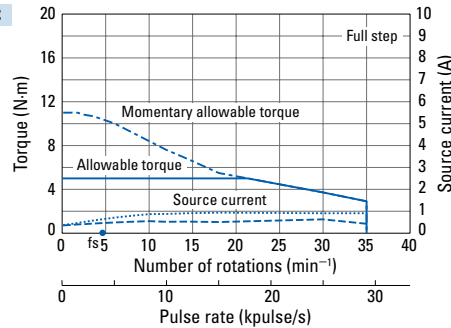

**48 VDC**

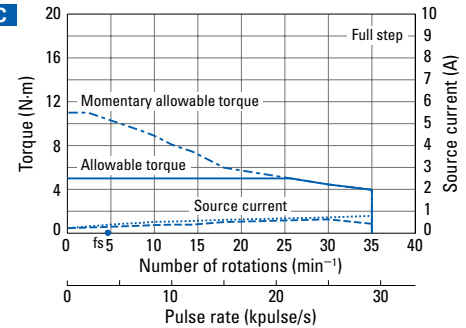

**FAM561S-HX50**  
**FAM561D-HX50**

**24 VDC**

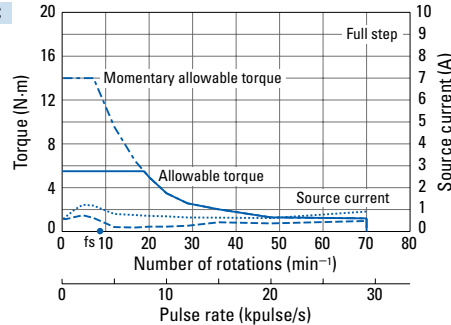

**48 VDC**

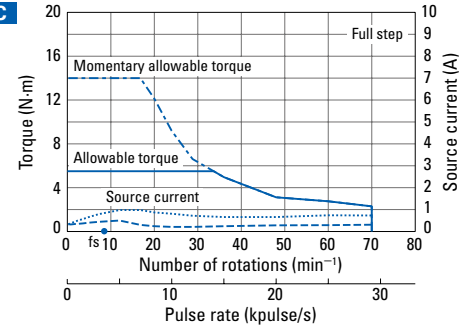

**FAM561S-HX100**  
**FAM561D-HX100**

**24 VDC**

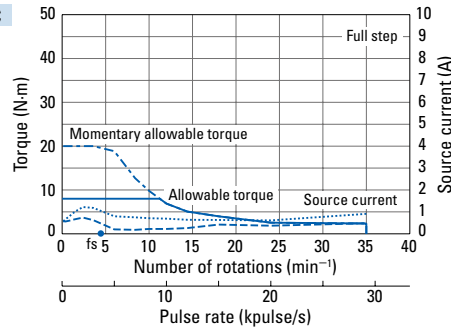

**48 VDC**

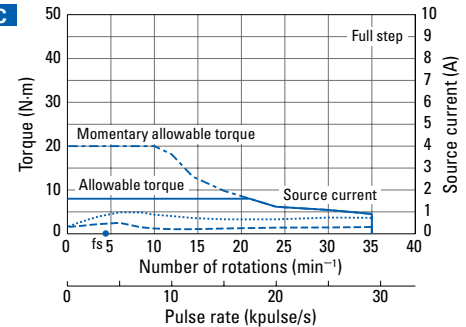

**FAM581S-HX50**  
**FAM581D-HX50**

**24 VDC**

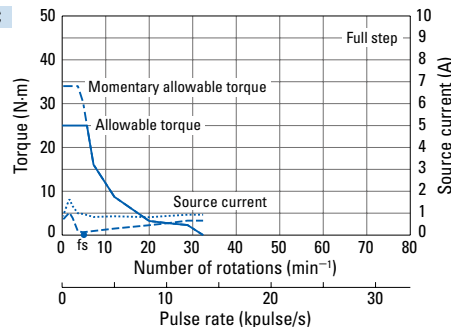

**48 VDC**

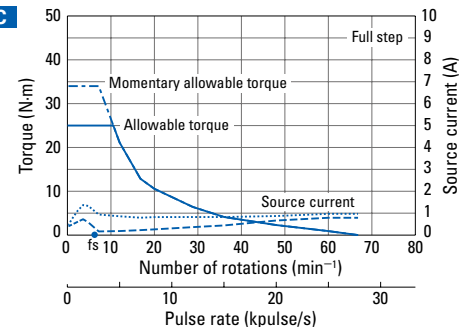

System Configuration Diagram ▶ p. 52 Set Model Configuration ▶ p. 54 Motor Dimensions ▶ pp. 71 to 74 Driver Dimensions ▶ p. 76

If allowable instantaneous torque is exceeded when using a motor with harmonic gears, the gears may be damaged. When selecting a motor, ensure that its allowable instantaneous torque will not be exceeded. Data is measured under the trial conditions of SANYO DENKI. Driving torque may vary according to actual machine precision.

## Harmonic gear model DC input Driver (Model number: F5PAE140P100) + Motor with harmonic gear

RoHS

Rated current: 28 mm sq. Motor 0.75 A/phase, 42 mm sq. to 86 mm sq. Motor 1.4 A/phase

Motor size	86 mm sq. (angular dimension 90 mm sq.)	
Motor + gear length	148 mm	
Single shaft	Set model number	FAM581S-HX100
	Configuration item: motor model number	SM5861-82HXM41
Dual shaft	Set model number	FAM581D-HX100
	Configuration item: motor model number	SM5861-82HXM11
Allowable torque	N·m	40
Momentary allowable torque	N·m	59
Rotor inertia	$\times 10^{-4}$ kg·m <sup>2</sup>	1.68
Rated current	A/phase	1.4
Basic step angle	°	0.0072
Gear ratio	—	1:100
Hysteresis loss	Arc min or less	-
Lost motion	Arc min	0.4 to 3 ( $\pm 1.2$ N·m)
Allowable speed	min <sup>-1</sup>	35
Motor mass *1	kg	3.6
Allowable thrust load	N	1400
Allowable radial load *2	N	1600

Note: The motor and gear output shaft rotate in the opposite direction.

\*1 Driver mass ▶ p. 77

\*2 When load is applied at 1/3 length from output shaft edge.

### Characteristics diagram

Winding current: 1.4A/phase

Momentary allowable torque ————  
Allowable torque ————

Source current (no load) ————  
Source current (load applied) ······

fs: Maximum self-start frequency when not loaded ●

**FAM581S-HX100**  
**FAM581D-HX100**

**24 VDC**

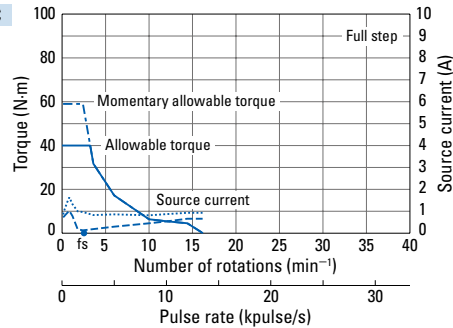

**48 VDC**

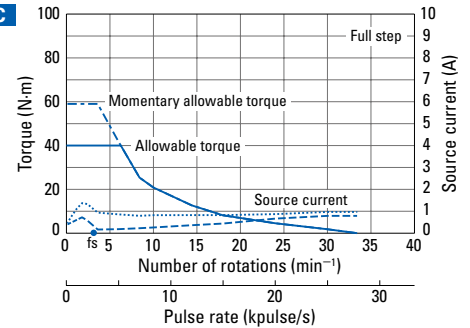



# Electromagnetic brake model

DC input Driver (Model number: F5PAE140P100) + Motor with electromagnetic brake

RoHS

Basic step angle: 0.72° Rated current: 1.4 A/phase

Motor size		42 mm sq.			60 mm sq.
Motor + brake length		68 mm	74.3 mm	82 mm	91.4 mm
Single shaft	Set model number	FAF541S-XB	FAF542S-XB	FAF543S-XB	FAM561S-XB
	Configuration item: motor model number	SF5421-82XB41	SF5422-82XB41	SF5423-82XB41	SM5601-82XB41
Holding torque	N·m min.	0.125	0.185	0.245	0.57
Rotor inertia	$\times 10^{-4}$ kg·m <sup>2</sup>	0.043	0.06	0.071	0.36
Rated current	A/phase	1.4	1.4	1.4	1.4
Motor mass *1	kg	0.39	0.46	0.53	0.96
Allowable thrust load	N	10	10	10	20
Allowable radial load *2	N	56	54	52	191
Electromagnetic brake	Brake type	No excitation actuating type			No excitation actuating type
	Power supply input	24±5%			24±5%
	Power consumption	2.4 (75°C)			6 (75°C)
	Static friction torque	0.3			0.8
	Brake operating time	20			20
	Brake release time	30			30

\*1 Driver mass ▶ p. 77

\*2 The load point is at the tip of the output shaft.

## Characteristics diagram

Winding current: 1.4A/phase  
With rubber coupling

Pull-out torque ———

Source current (no load) - - - - -

Source current (load applied) ·······

fs: Maximum self-start frequency when not loaded ●

### FAF541S-XB

24 VDC

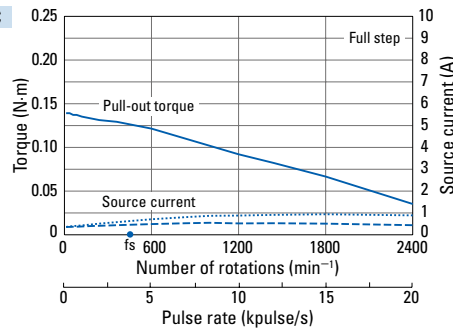

48 VDC

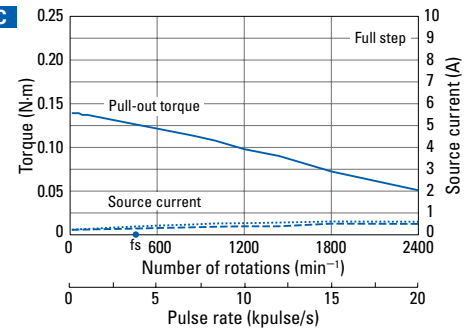

### FAF542S-XB

24 VDC

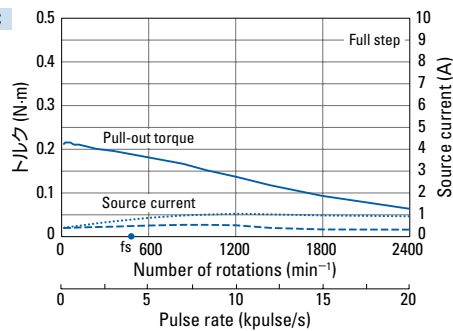

48 VDC

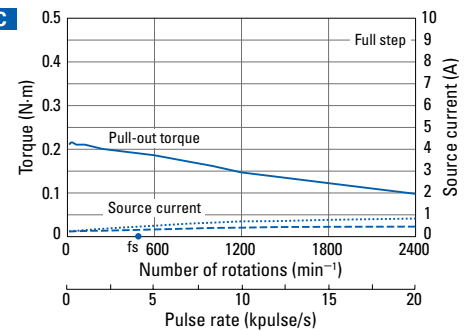

### FAF543S-XB

24 VDC

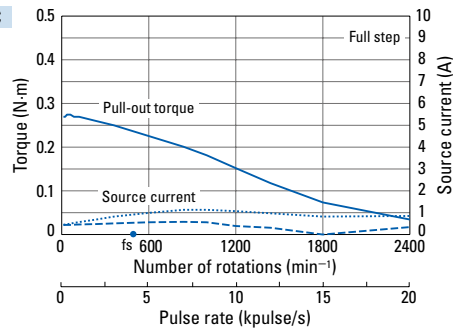

48 VDC

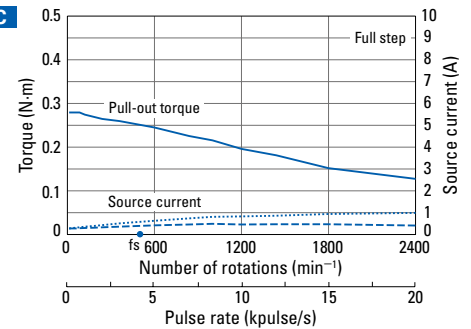

### FAM561S-XB

24 VDC

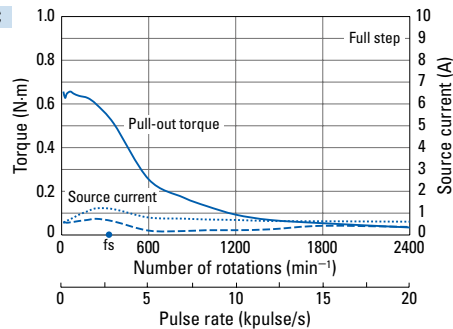

48 VDC

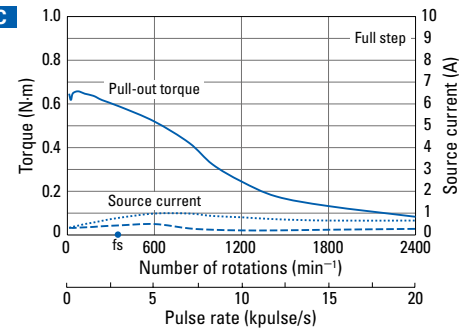

System Configuration Diagram ▶ p. 52 Set Model Configuration ▶ p. 54 Motor Dimensions ▶ pp. 71 to 74 Driver Dimensions ▶ p. 76

The electromagnetic brake only works when the motor is stopped, and cannot be used for braking.

Data is measured under the trial conditions of SANYO DENKI. Driving torque may vary according to actual machine precision.

## Electromagnetic brake model

DC input Driver (Model number: F5PAE140P100) + Motor with electromagnetic brake

RoHS

Basic step angle: 0.72° Rated current: 1.4 A/phase

Motor size		60 mm sq.		86 mm sq.	
Motor + brake length		102.6 mm	131.3 mm	119.5 mm	150 mm
Single shaft	Set model number	FAM562S-XB	FAM563S-XB	FAM581S-XB	FAM582S-XB
Configuration item: motor model number		SM5602-82XB41	SM5603-82XB41	SM5861-82XB41	SM5862-82XB41
Holding torque	N·m min.	0.9	1.7	2.3	4.4
Rotor inertia	$\times 10^{-4}$ kg·m <sup>2</sup>	0.47	0.76	2.55	4.07
Rated current	A/phase	1.4	1.4	1.4	1.4
Motor mass *1	kg	1.14	1.61	2.6	3.75
Allowable thrust load	N	20	20	60	60
Allowable radial load *2	N	183	170	200	200
Electromagnetic brake	Brake type	No excitation actuating type		No excitation actuating type	
	Power supply input	24±5%		24±10%	
	Power consumption	6 (75°C)		10.5 (20°C)	
	Static friction torque	0.8		5	
	Brake operating time	20		20	
	Brake release time	30		50	

\*1 Driver mass ▶ p. 77

\*2 The load point is at the tip of the output shaft.

### Characteristics diagram

Winding current: 1.4A/phase  
With rubber coupling

Pull-out torque ——— Source current (no load) - - - - -  
fs: Maximum self-start frequency when not loaded ●

Source current (load applied) ·······

#### FAM562S-XB

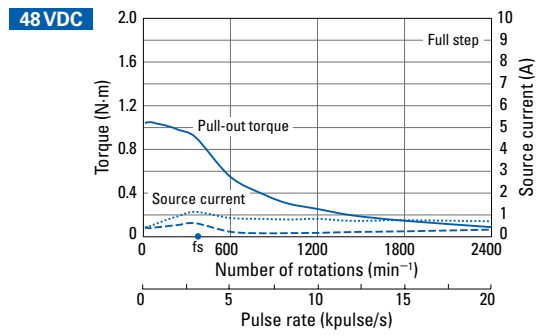
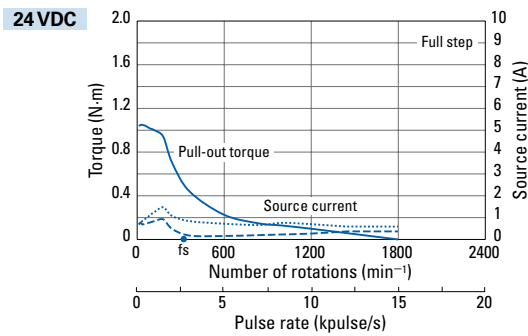

#### FAM563S-XB

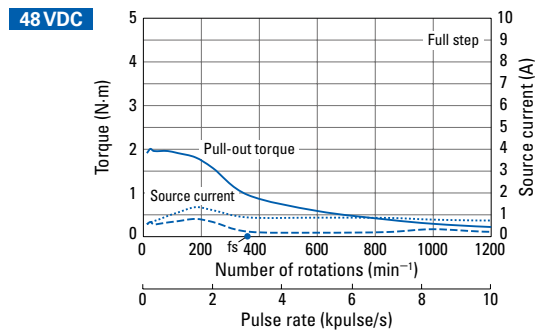
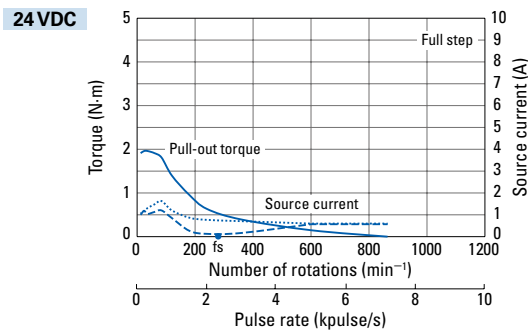

#### FAM581S-XB

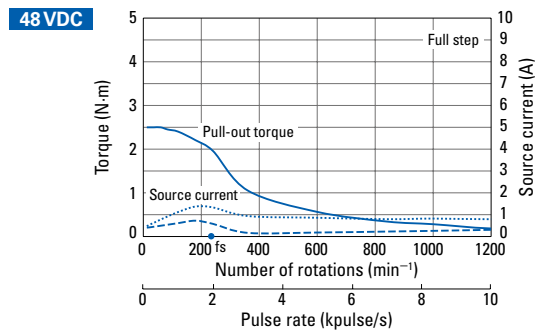
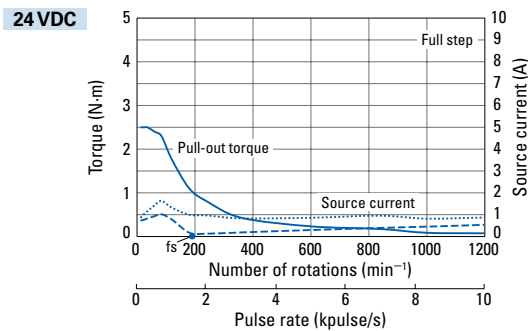

#### FAM582S-XB

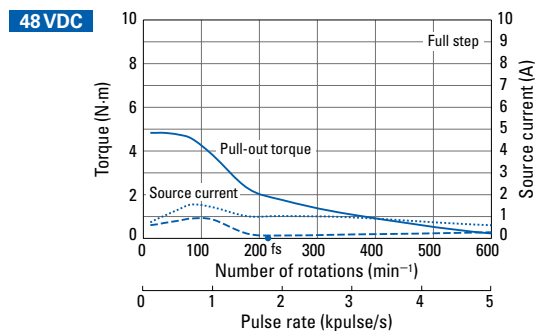
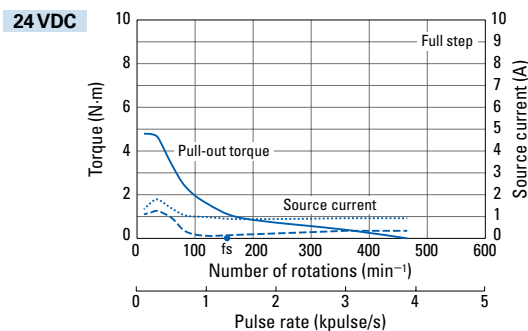

# Stepping Motor: Dimensions

(Unit: mm) Common to microstep and full/half step.

## Standard model

### 28 mm sq.

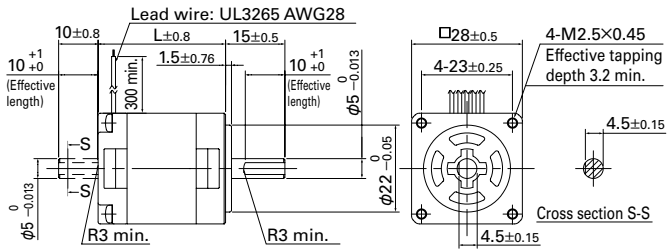

Set model number		Motor model number		Motor length (L)
Single shaft	Dual shaft	Single shaft	Dual shaft	
FAF521S	FAF521D	SH5281-7241	SH5281-7211	32
FDF521S	FDF521D			
FAF525S	FAF525D	SH5285-7241	SH5285-7211	51.5
FDF525S	FDF525D			

### 42 mm sq.

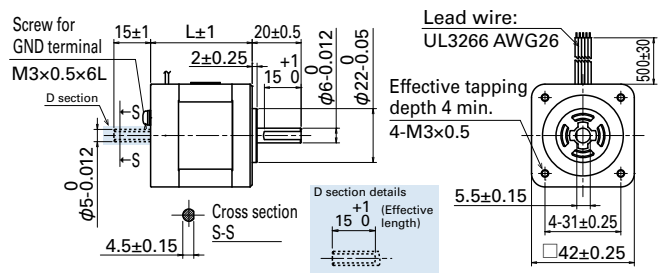

Set model number		Motor model number		Motor length (L)
Single shaft	Dual shaft	Single shaft	Dual shaft	
FAF541S	FAF541D	SF5421-8241	SF5421-8211	35
FDF541S	FDF541D			
FAF542S	FAF542D	SF5422-8241	SF5422-8211	41
FDF542S	FDF542D			
FAF543S	FAF543D	SF5423-8241	SF5423-8211	49
FDF543S	FDF543D			

### 60 mm sq.

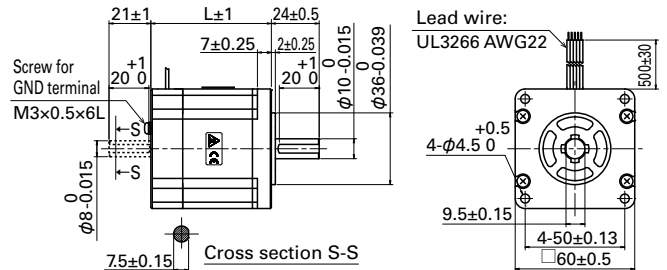

Set model number		Motor model number		Motor length (L)
Single shaft	Dual shaft	Single shaft	Dual shaft	
FAM561S	FAM561D	SM5601-8241	SM5601-8211	49
FDM561S	FDM561D			
FAM562S	FAM562D	SM5602-8241	SM5602-8211	60
FDM562S	FDM562D			
FAM563S	FAM563D	SM5603-8241	SM5603-8211	89
FDM563S	FDM563D			

### 86 mm sq.

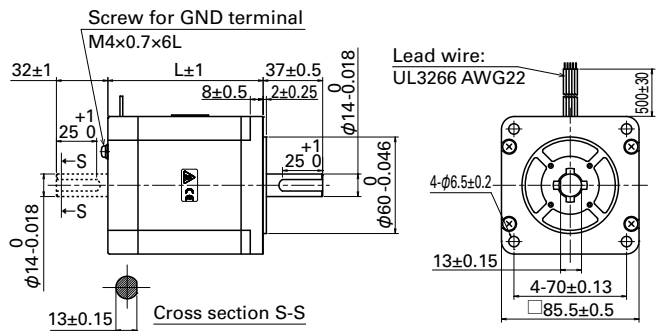

Set model number		Motor model number		Motor length (L)
Single shaft	Dual shaft	Single shaft	Dual shaft	
FAM581S	FAM581D	SM5861-8241	SM5861-8211	66
FDM581S	FDM581D			
FAM582S	FAM582D	SM5862-8241	SM5862-8211	96.5
FDM582S	FDM582D			

## Spur gear model

### 28 mm sq.

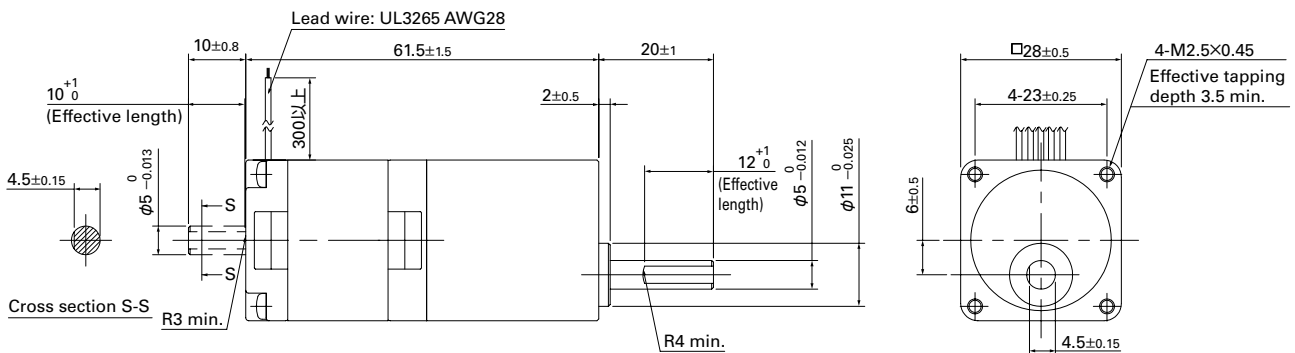

Set model number		Motor model number	
Single shaft	Dual shaft	Single shaft	Dual shaft
F□F521S-GX3.6	F□F521D-GX3.6	SH5281-72GX4	SH5281-72GX1
F□F521S-GX7.2	F□F521D-GX7.2	SH5281-72GX4	SH5281-72GX1
F□F521S-GX10	F□F521D-GX10	SH5281-72GX4	SH5281-72GX1
F□F521S-GX20	F□F521D-GX20	SH5281-72GX4	SH5281-72GX1
F□F521S-GX30	F□F521D-GX30	SH5281-72GX4	SH5281-72GX1
F□F521S-GX50	F□F521D-GX50	SH5281-72GX4	SH5281-72GX1

For '□' in the set model numbers, 'A' indicates DC input microstep, and 'D' indicates DC input full/half step.

## Stepping Motor: Dimensions

(Unit: mm) Common to microstep and full/half step.

### Low-backlash gear model

#### 42 mm sq.

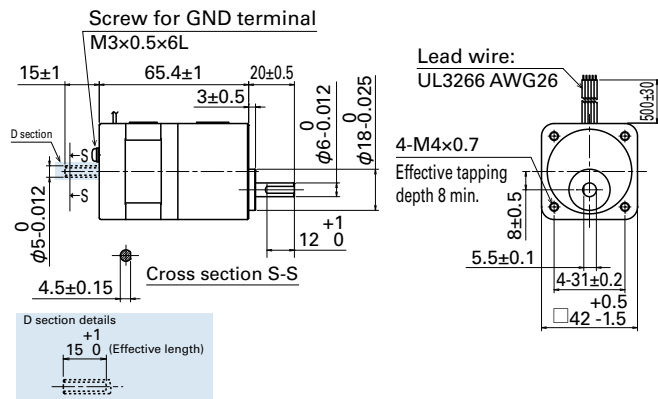

#### 60 mm sq.

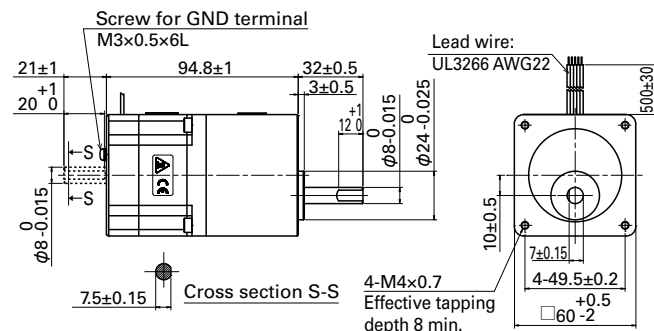

Set model number		Motor model number	
Single shaft	Dual shaft	Single shaft	Dual shaft
F□F541S-CX3.6	F□F541D-CX3.6	SF5421-82CXA41	SF5421-82CXA11
F□F541S-CX7.2	F□F541D-CX7.2	SF5421-82CXB41	SF5421-82CXB11
F□F541S-CX10	F□F541D-CX10	SF5421-82CXE41	SF5421-82CXE11
F□F541S-CX20	F□F541D-CX20	SF5421-82CXG41	SF5421-82CXG11
F□F541S-CX30	F□F541D-CX30	SF5421-82CXJ41	SF5421-82CXJ11
F□F541S-CX36	F□F541D-CX36	SF5421-82CXX41	SF5421-82CXX11

For '□' in the set model numbers, 'A' indicates DC input microstep, and 'D' indicates DC input full/half step.

Set model number		Motor model number	
Single shaft	Dual shaft	Single shaft	Dual shaft
F□M561S-CX3.6	F□M561D-CX3.6	SM5601-82CXA41	SM5601-82CXA11
F□M561S-CX7.2	F□M561D-CX7.2	SM5601-82CXB41	SM5601-82CXB11
F□M561S-CX10	F□M561D-CX10	SM5601-82CXE41	SM5601-82CXE11
F□M561S-CX20	F□M561D-CX20	SM5601-82CXG41	SM5601-82CXG11
F□M561S-CX30	F□M561D-CX30	SM5601-82CXJ41	SM5601-82CXJ11
F□M561S-CX36	F□M561D-CX36	SM5601-82CXX41	SM5601-82CXX11

For '□' in the set model numbers, 'A' indicates DC input microstep, and 'D' indicates DC input full/half step.

#### 86 mm sq.

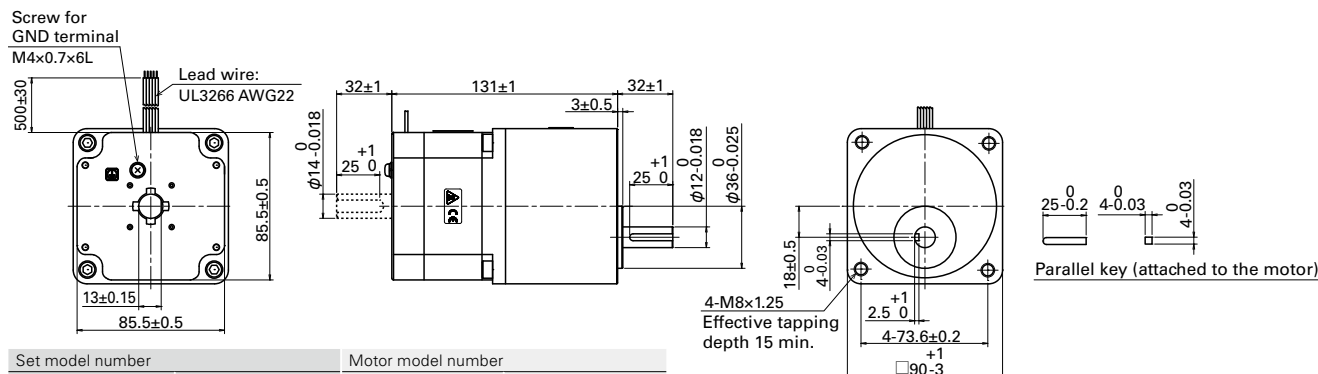

Set model number		Motor model number	
Single shaft	Dual shaft	Single shaft	Dual shaft
F□M581S-CX3.6	F□M581D-CX3.6	SM5861-82CXA41	SM5861-82CXA11
F□M581S-CX7.2	F□M581D-CX7.2	SM5861-82CXB41	SM5861-82CXB11
F□M581S-CX10	F□M581D-CX10	SM5861-82CXE41	SM5861-82CXE11
F□M581S-CX20	F□M581D-CX20	SM5861-82CXG41	SM5861-82CXG11
F□M581S-CX30	F□M581D-CX30	SM5861-82CXJ41	SM5861-82CXJ11
F□M581S-CX36	F□M581D-CX36	SM5861-82CXX41	SM5861-82CXX11

For '□' in the set model numbers, 'A' indicates DC input microstep, and 'D' indicates DC input full/half step.

### Harmonic gear model

#### 28 mm sq.

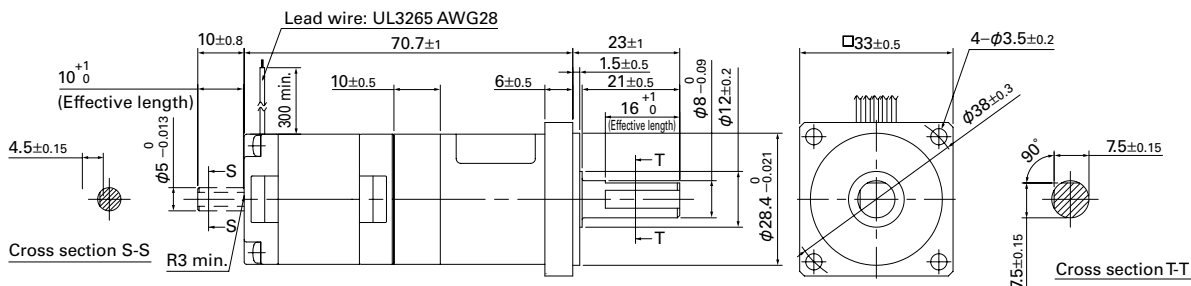

Set model number		Motor model number	
Single shaft	Dual shaft	Single shaft	Dual shaft
FAF521S-HX50	FAF521D-HX50	SH5281-72HXL4	SH5281-72HXL1
FD521S-HX50	FD521D-HX50		
FAF521S-HX100	FAF521D-HX100	SH5281-72HXM4	SH5281-72HXM1
FD521S-HX100	FD521D-HX100		

## Harmonic gear model

### 42 mm sq.

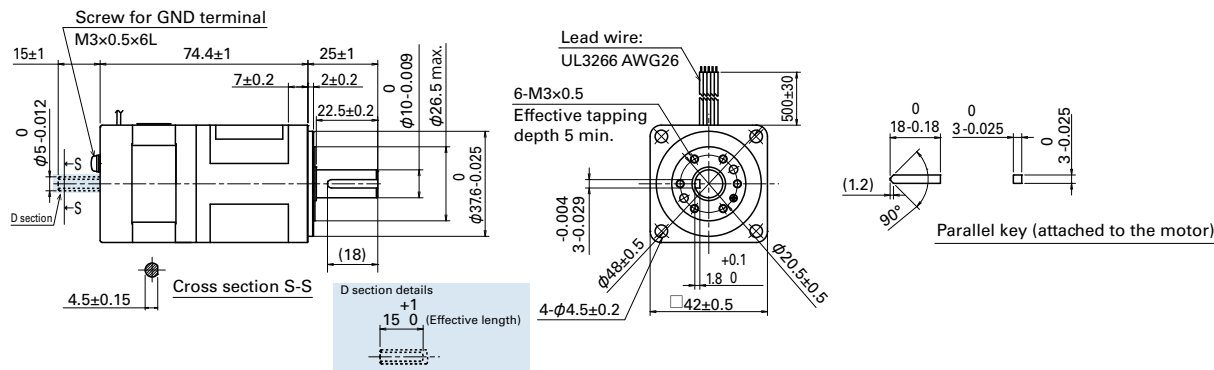

Set model number		Motor model number	
Single shaft	Dual shaft	Single shaft	Dual shaft
FAF541S-HX30	FAF541D-HX30	SF5421-82HXJ41	SF5421-82HXJ11
FDF541S-HX30	FDF541D-HX30		
FAF541S-HX50	FAF541D-HX50	SF5421-82HXL41	SF5421-82HXL11
FDF541S-HX50	FDF541D-HX50		
FAF541S-HX100	FAF541D-HX100	SF5421-82HXM41	SF5421-82HXM11
FDF541S-HX100	FDF541D-HX100		

### 60 mm sq.

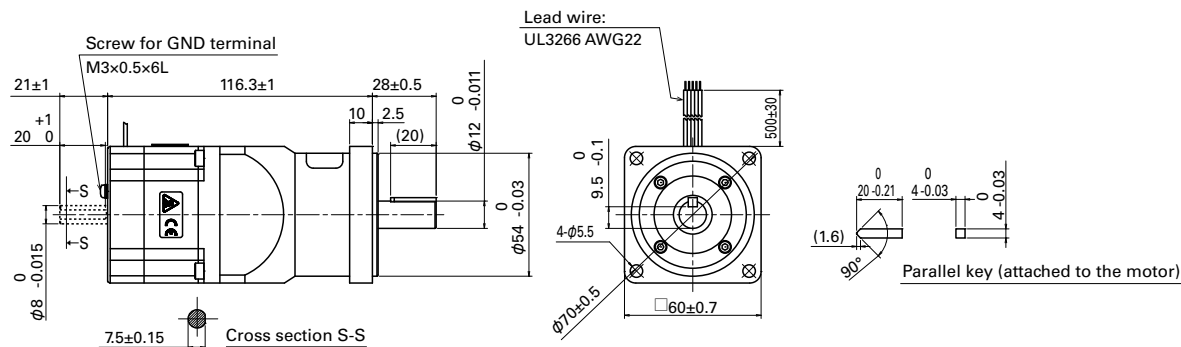

Set model number		Motor model number	
Single shaft	Dual shaft	Single shaft	Dual shaft
FAM561S-HX50	FAM561D-HX50	SM5601-82HXL41	SM5601-82HXL11
FDM561S-HX50	FDM561D-HX50		
FAM561S-HX100	FAM561D-HX100	SM5601-82HXM41	SM5601-82HXM11
FDM561S-HX100	FDM561D-HX100		

### 86 mm sq.

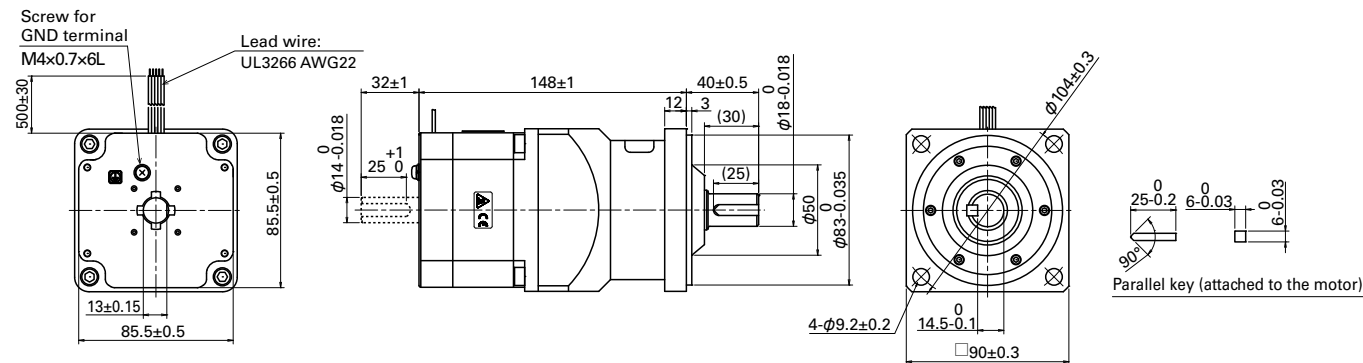

Set model number		Motor model number	
Single shaft	Dual shaft	Single shaft	Dual shaft
FAM581S-HX50	FAM581D-HX50	SM5861-82HXL41	SM5861-82HXL11
FDM581S-HX50	FDM581D-HX50		
FAM581S-HX100	FAM581D-HX100	SM5861-82HXM41	SM5861-82HXM11
FDM581S-HX100	FDM581D-HX100		

# Stepping Motor: Dimensions

(Unit: mm) Common to microstep and full/half step.

## Electromagnetic brake model

### 42 mm sq.

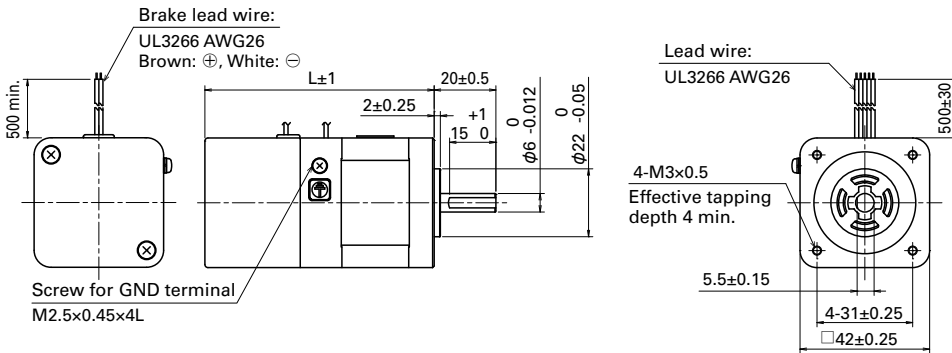

Set model number		Motor model number		Motor length (L)
Single shaft	Dual shaft	Single shaft	Dual shaft	
FAF541S-XB	-	SF5421-82XB41	-	68
FAF542S-XB	-	SF5422-82XB41	-	74.3
FAF543S-XB	-	SF5423-82XB41	-	82

### 60 mm sq.

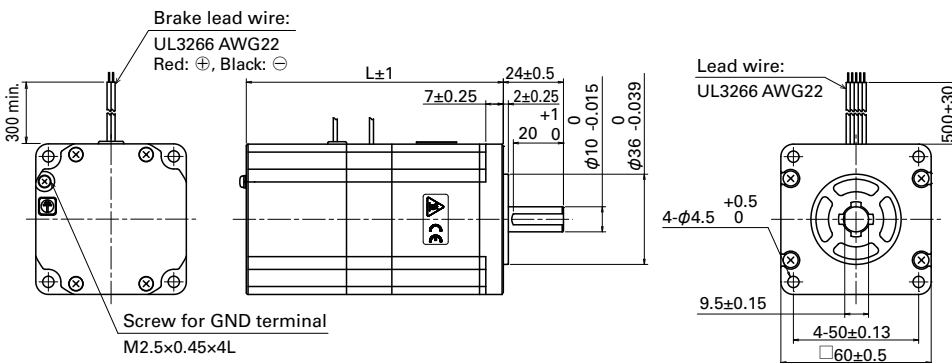

Set model number		Motor model number		Motor length (L)
Single shaft	Dual shaft	Single shaft	Dual shaft	
FAM561S-XB	-	SM5601-82XB41	-	91.4
FAM562S-XB	-	SM5602-82XB41	-	102.6
FAM563S-XB	-	SM5603-82XB41	-	131.3

### 86 mm sq.

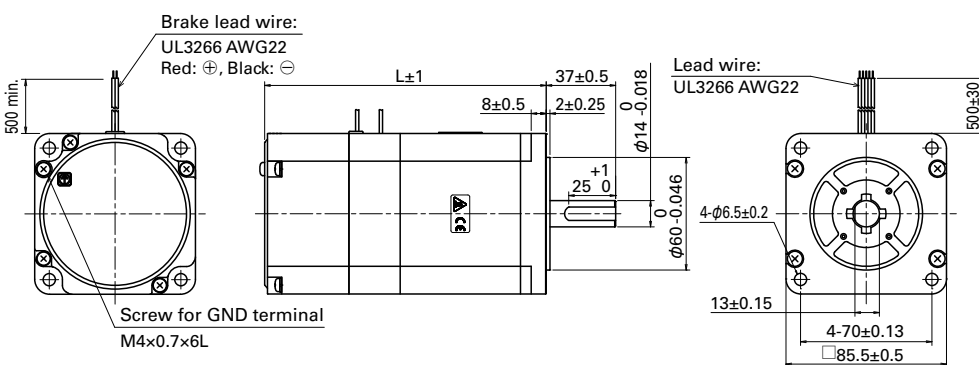

Set model number		Motor model number		Motor length (L)
Single shaft	Dual shaft	Single shaft	Dual shaft	
FAM581S-XB	-	SM5861-82XB41	-	119.5
FAM582S-XB	-	SM5862-82XB41	-	150



# Stepping Motor: General Specifications Common to microstep and full/half step.

Motor model number	SH528□	SF542□	SM560□	SM586□
Type	—		S1 (continuous operation)	
Operating ambient temperature	-10°C to +50°C (0 to +40°C for harmonic gear model)		-10°C to +40°C (0 to +40°C for harmonic gear model)	
Storage temperature	-20°C to +65°C		-20°C to +60°C	
Operating ambient humidity	20 to 90% RH (no condensation)		95% RH max.: Under 40°C (no condensation)	
Storage humidity	5 to 95% RH (no condensation)		95% RH max.: Under 40°C, 57% RH max.: Under 50°C, 35% RH max.: Under 60°C (no condensation)	
Operation altitude	1000 m or less above sea level			
Vibration resistance	Vibration frequency 10 to 500 Hz, total amplitude 1.52 mm (10 to 70 Hz), vibration acceleration 150 m/s <sup>2</sup> (70 to 500 Hz), sweep time 15 min/cycle, 12 sweeps in each X,Y and Z direction.			
Impact resistance	500 m/s <sup>2</sup> of acceleration for 11 ms with half-sine wave applying three times for X,Y and Z axes each, 18 times in total.			
Thermal class	B (+130°C)		F (+155°C)	
Withstandable voltage	At normal temperature and humidity, no failure with 500 VAC @ 50/60 Hz applied for one minute between motor winding and frame.		At normal temperature and humidity, no failure with 1500 VAC @ 50/60 Hz applied for one minute between motor winding and frame.	
Insulation resistance	At normal temperature and humidity, not less than 100 MΩ between winding and frame by 500 VDC megger.			
Protection grade	IP40			
Winding temperature rise	80 K max. (Based on SANYO DENKI standard)		85 K max. (Based on SANYO DENKI standard)	
Static angle error	±0.09°			
Thrust play *1	0.075 mm max. (load: 1.5 N)	0.075 mm max. (load: 5 N)	0.075 mm max. (load: 10 N)	0.075 mm max. (load: 10 N)
Radial play *2	0.025 mm max. (load: 5 N)	0.025 mm max. (load: 5 N)	0.025 mm max. (load: 5 N)	0.025 mm max. (load: 5 N)
Shaft runout	0.025 mm	0.025 mm	0.025 mm	0.025 mm
Concentricity of mounting pilot relative to shaft	φ0.05 mm	φ0.05 mm	φ0.075 mm	φ0.075 mm
Squareness of mounting surface relative to shaft	0.1 mm	0.1 mm	0.1 mm	0.15 mm
Direction of motor mounting	Can be freely mounted vertically or horizontally			

\*1 Thrust play: Shaft displacement under axial load.

\*2 Radial play: Shaft displacement under radial load applied 1/3rd of the length from the end of the shaft.

## Safety standards

Model number: SM560□ SM586□

CE marking	Directives	Applicable standard
	Low-voltage directives (2014/35/EU)	EN60034-1, EN60034-5

UL	Acquired standards	Applicable standard	File No.
	UL	UL1004-1, UL1004-6	E179832 (PRHZ2)
	c-UL	CSA C22.2 No.100	E179832 (PRHZ8)

# Internal Wiring and Rotation Direction Common to microstep and full/half step.

## Internal wire connection

Connection Method:

New pentagon connection

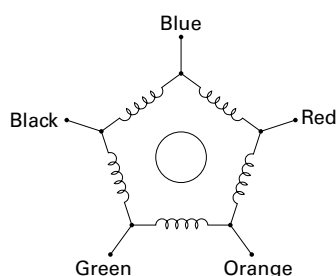

## Direction of motor rotation

When excited by a direct current in the order shown below, the direction of rotation is clockwise as viewed from the output shaft side.

\*This is an instance of the standard model and the electromagnetic brake model.

As for some of the models with the gear, the direction of motor rotation is different, please make inquiries.

	Exciting order										
		1	2	3	4	5	6	7	8	9	10
Lead wire color	Blue			+	+	+		-	-	-	
	Red	-	-			+	+	+		-	
	Orange		-	-	-			+	+	+	
	Green	+			-	-				+	+
	Black	+	+	+				-	-	-	



# Driver Dimensions (Unit: mm)

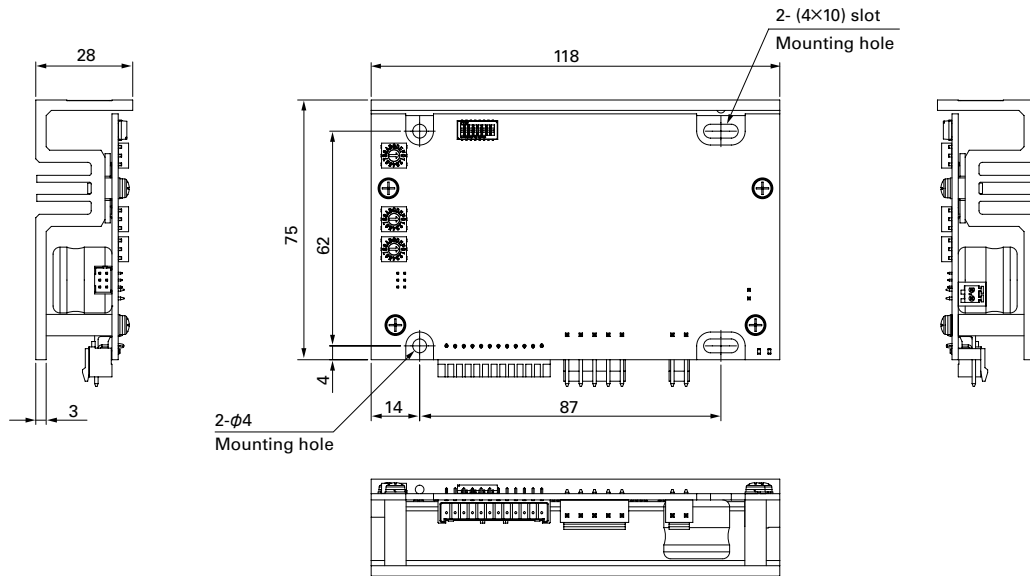

# Driver Specifications

## General specifications

Basic specifications	Model number	F5PAE140P100	
	Main circuit power	24 VDC/48 VDC $\pm$ 10%*1	
	Main circuit power supply current	3 A	
	Environment	Protection class	Class III
		Operation environment	Installation category (over-voltage category): I (CE) Pollution level: 2
		Operating ambient temperature	0 to +50°C
		Storage temperature	-20 to +70°C
		Operating ambient humidity	35 to 85% RH (no condensation)
		Storage humidity	10 to 90% RH (no condensation)
		Operation altitude	1000 m or less above sea level
		Vibration resistance	Tested under the following conditions; 5 m/s <sup>2</sup> , frequency range 10 to 55 Hz, direction along X, Y and Z axes, for 2 hours each
		Impact resistance	20 m/s <sup>2</sup>
		Withstandable voltage	Not influenced when 0.5 kVAC is applied between power input terminal and cabinet for one minute.
Insulation resistance	10 M $\Omega$ min. when measured with 500 VDC megohmmeter between input terminal and cabinet.		
Mass	0.23 kg		
Functions	Selection function	Pulse input type (1-input type/2-input type), low-vibration mode (low-vibration drive/ microstep drive), resolution (2-phase mode/5-phase mode), output signal (phase origin monitor/alarm), operating current, step-angle	
	Protection functions	Overcurrent protection	
	LED indication	Power supply monitor, alarm display (main power supply under- and overvoltage, regenerative fault, overcurrent fault, hardware fault)	
I/O signals	Auto-Current-Down canceling input signal	Photocoupler input system; input resistance: 330 $\Omega$ Input-signal "H" level: 4.5 to 5.5 V; input-signal "L" level: 0 to 0.5 V	
	Step-angle selection input	Photocoupler input system; input resistance: 330 $\Omega$ Input-signal "H" level: 4.5 to 5.5 V; input-signal "L" level: 0 to 0.5 V	
	Command pulse input signal	Photocoupler input system; input resistance: 330 $\Omega$ Input-signal "H" level: 4.5 to 5.5 V; input-signal "L" level: 0 to 0.5 V Provided that voltage between Level H to L shall be 4.5 V or over. Maximum input frequency: 400 kpulse/s	
	Power down input signal	Photocoupler input system; input resistance: 330 $\Omega$ Input-signal "H" level: 4.5 to 5.5 V; input-signal "L" level: 0 to 0.5 V	
	Phase origin monitor output signal/ Alarm output signal	Open collector output via photocoupler Output signal standard V <sub>ceo</sub> : 30 V or less *2 I <sub>c</sub> : 5 mA or less V <sub>ce</sub> (sat): 1.0 V or less	

\*1 Use either 24 VDC $\pm$ 10% or 48 VDC $\pm$ 10% for main circuit power supply. Make sure never exceed 60 VDC, even if power supply voltage increases due to counter-electromotive force after misstep occurs. If there are any possibilities of exceeding 60 VDC, connect optional regenerative resistor. Regenerative resistor use is recommended if you operate with 60 mm sq. or 86 mm sq. motor.

\*2 Make sure the voltage used for output signal is 5 VDC or over.

## Safety standards

	Directives	Category	Standard	Name
CE (TÜV)	Low-voltage directives	—	EN61800-5-1	—
	EMC directives	Emission	EN61000-6-4	Conducted emissions test
			EN61000-6-4	Electromagnetic radiation disturbance
		Immunity	EN61000-4-2	ESD (Electrostatic discharge)
			EN61000-4-3	RS (Radio-frequency amplitude modulated electromagnetic field)
			EN61000-4-4	Fast transients
			EN61000-4-5	CS (Radio-frequency common mode)
	EN61000-4-6	Surges		
UL	Acquired standards		Applicable standard	File No.
	UL		UL508C	E179775
	UL for Canada (c-UL)			

- EMC characteristics may vary depending on the configuration of the users' control panel, which contains the driver or stepping motor, or the arrangement and wiring of other electrical devices.  
Parts for EMC noise suppression like noise filters and toroidal type ferrite cores may be required depending on circumstances.
- Validation test of driver has been performed for low-voltage EMC directives at TÜV (TÜV product service) for self-declaration of CE marking.

# Driver Controls and Connectors

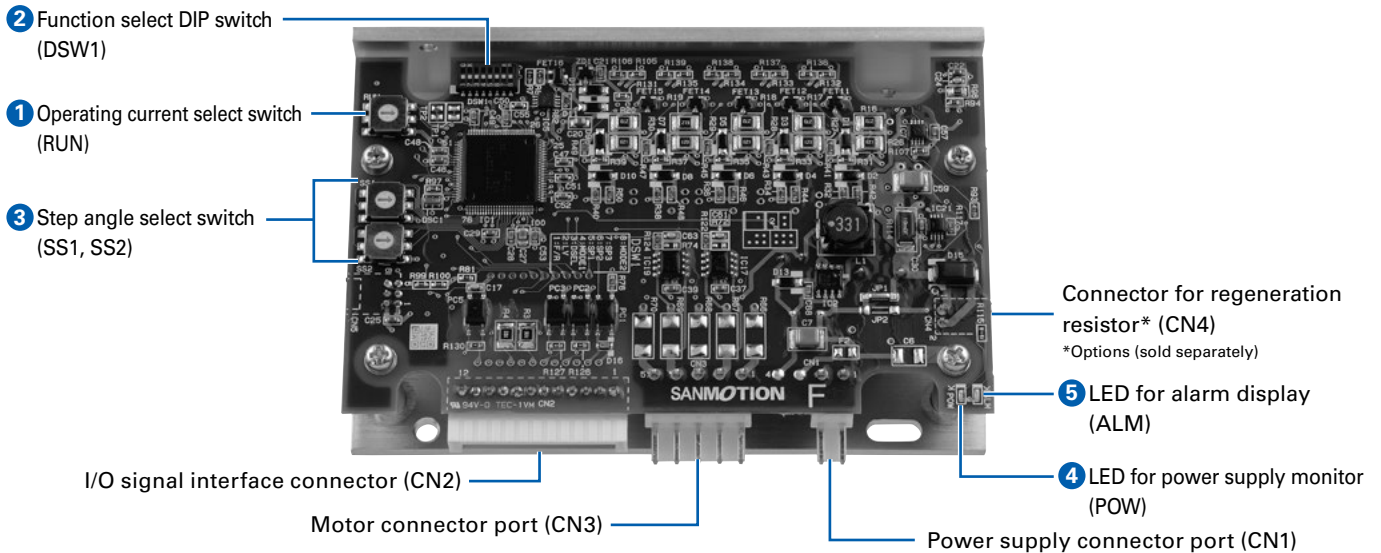

## 1. Operating current select switch (RUN)

Operating motor current value can be set with the rotary switch.

Dial	0	1	2	3	4	5	6	7
Stepping motor current (A)	1.4	1.35	1.3	1.25	1.2	1.15	1.1	1.05
Dial	8	9	A	B	C	D	E	F
Stepping motor current (A)	1.0	0.95	0.9	0.85	0.8	0.75	0.7	0.65

- The factory default value is F (0.65 A).
- Please check the rated current of the motor to be combined before selecting the operation current.
- If there are sufficient margin of motor torque, decreasing operating current value becomes effective for vibration reduction. Motor output torque is approximately proportional to current.
- Make sure to confirm there are sufficient operation margin before determining motor current value to adjust operating current.

## 2. Function select DIP switch (DSW1)

Select the function depending on your specification.  
Factory default settings

F/R	<input type="checkbox"/>	OFF	2-input type (CW/CCW pulse input)
LV	<input type="checkbox"/>	OFF	Microstep
DSEL	<input type="checkbox"/>	OFF	5-phase mode
MODE1	<input type="checkbox"/>	OFF	Phase origin monitor output
SP1	<input type="checkbox"/>		Settings vary depending on motors to be connected. Perform setting for motor you use first by confirming the [table of setting for motors to be connected] below.
SP2	<input type="checkbox"/>		
SP3	<input type="checkbox"/>		
MODE2	<input type="checkbox"/>	OFF	Reservation (Don't turn it ON)

- Perform setting for motor to be connected first.
- Make sure to turn off power supply of the driver when changing setting s of function select DIP switch.

[Table of setting for motors to be connected]

SP1	SP2	SP3	Motor to be connected
OFF	OFF	OFF	SH5281-72□□, SH5285-72□□, SF5421-82□□
OFF	OFF	ON	SF5422-82□□
OFF	ON	OFF	SF5423-82□□
OFF	ON	ON	SM5601-82□□
ON	OFF	OFF	SM5602-82□□
ON	OFF	ON	SM5603-82□□, SM5861-82□□
ON	ON	OFF	SM5862-82□□

### 1. Pulse input type selection (F/R)

Select the input pulse type.

F/R	Pulse input type
ON	1-input type (CK, U/D)
OFF	2-input type (CW, CCW)

### 2. Low-vibration mode select (LV)

Provides low-vibration, smooth operation even if resolution is rough (1-division, 2-division, etc)

LV	Operation
ON	Low-vibration drive
OFF	Microstep

### 3. Resolution selection (DSEL)

Select the step angle select switch (SS1, SS2) mode.

DSEL	Resolution mode
ON	2-phase mode: Operation as normal 2-phase stepping system at 1.8° to 0.00703125° -step angle is available.
OFF	5-phase mode: Operation as normal 5-phase stepping system at 0.72° to 0.00288° -step angle is available.

## 4. Output signal selection (MODE1)

Select the output signal

MODE1	Output signal
ON	Alarm output
OFF	Phase origin monitor output

## 5 to 7. Motor selection (SP1, SP2, SP3)

Perform setting for motor you use first by confirming the [table of setting for motors to be connected].

## 8. (MODE2)

Do not turn ON this switch.

## 3. Step angle select switch (SS1, SS2)

The number of divisions of the stepping motor basic step angle can be set with the rotary switch.

After selecting 2- or 5-phase mode by function select DIP switch 3 (DSEL), set the step angle select switches for the desired step angle.

5-Phase Mode: DSW1 function select DIP switch 3 = OFF				2-Phase Mode: DSW1 function select DIP switch 3 = ON			
SS1, SS2	Number of divisions	Resolution	Basic step angle	SS1, SS2	Number of divisions	Resolution	Basic step angle
0	1	500	0.72°	0	0.4	200	1.8°
1	2	1000	0.36°	1	0.8	400	0.9°
2	2.5	1250	0.288°	2	1.6	800	0.45°
3	4	2000	0.18°	3	2	1000	0.36°
4	5	2500	0.144°	4	3.2	1600	0.225°
5	8	4000	0.09°	5	4	2000	0.18°
6	10	5000	0.072°	6	6.4	3200	0.1125°
7	20	10000	0.036°	7	10	5000	0.072°
8	25	12500	0.0288°	8	12.8	6400	0.05625°
9	40	20000	0.018°	9	20	10000	0.036°
A	50	25000	0.0144°	A	25.6	12800	0.028125°
B	80	40000	0.009°	B	40	20000	0.018°
C	100	50000	0.0072°	C	50	25000	0.0144°
D	125	62500	0.00576°	D	51.2	25600	0.0140625°
E	200	100000	0.0036°	E	100	50000	0.0072°
F	250	125000	0.00288°	F	102.4	51200	0.00703125°

- Factory default setting: SS1 = 1 and SS2 = 0
- Set the step angle select input (DSEL) to select SS1 or SS2, then set the rotary switch.

## 4. LED for power supply monitor (POW)

Lights up when the control power and main circuit power supply are connected.

## 5. LED for alarm display (ALM)

Flashes repeatedly when an alarm is generated.

Indication	Explanation
"ALM" repeats single-flashing.	Main power supply voltage drop (Detected when excitation is on.)
"ALM" repeats double-flashing.	Overvoltage of main power supply (Detected when motor stops.)
"ALM" repeats triple-flashing.	Regeneration error (Detected when motor is operating.)
"ALM" repeats quadruple-flashing.	Overcurrent error
"ALM" repeats five-times-flashing.	Hardware error

- When alarm activated, stepping motor winding current is interrupted and then the state becomes "not-excited" at the same time that LED "ALM" flashes.
- When "DSW1: MODE1" is set to ON, signal is output outward from alarm output terminal (AL). (Photocoupler is turned on.)
- This state is maintained until the power supply is turned off. Please re-turn on the power supply after eliminating alarm cause.

# Connections and Signals

## External wiring diagram

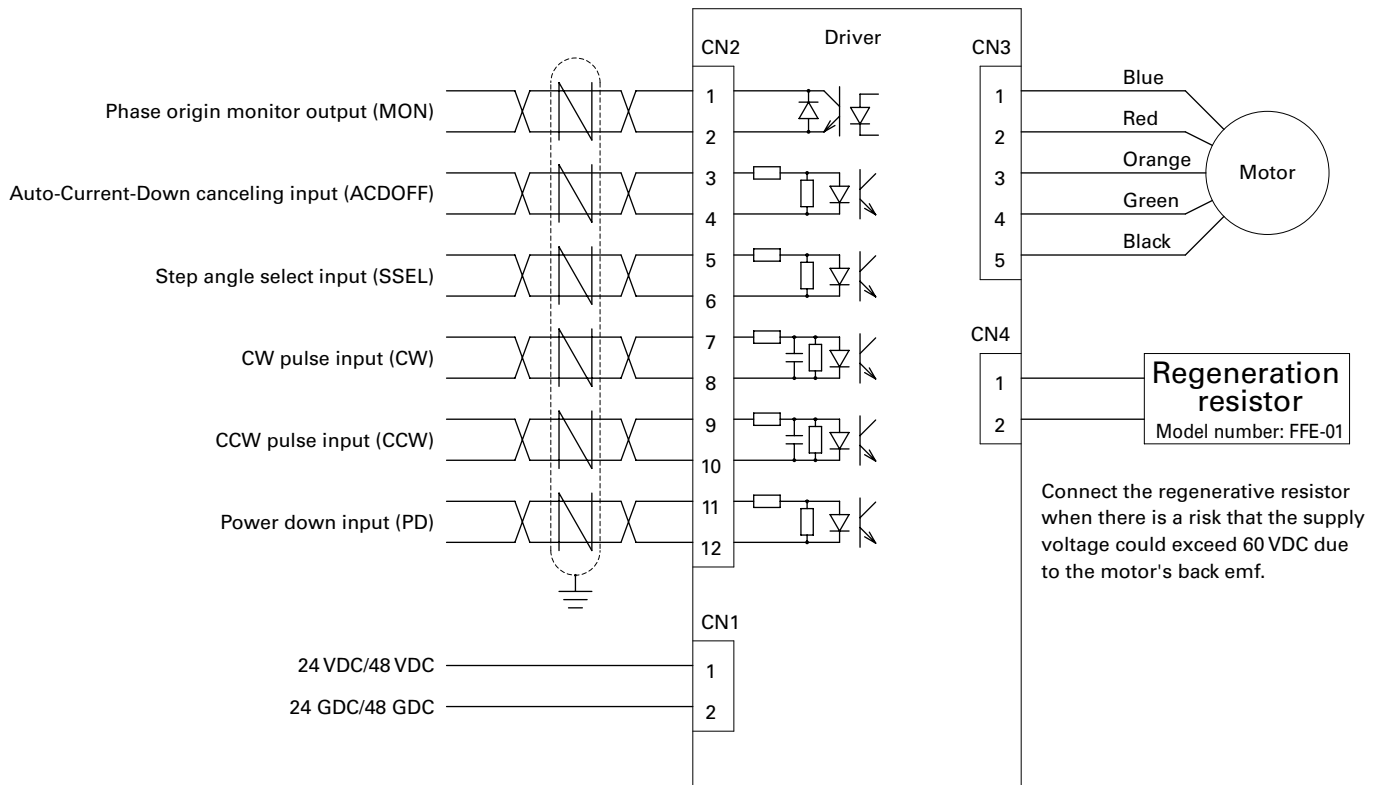

## Applicable wire sizes

Part	Applicable wire	Insulation diameter	Wiring length
For power supply	AWG20 (0.5 mm <sup>2</sup> ) to AWG18 (0.75 mm <sup>2</sup> )	φ1.7 to φ3.0 mm	Under 3 m
For input/output signal	AWG24 (0.2 mm <sup>2</sup> ) to AWG22 (0.3 mm <sup>2</sup> )	φ1.15 to φ1.8 mm	Under 3 m
For motor	AWG20 (0.5 mm <sup>2</sup> ) to AWG18 (0.75 mm <sup>2</sup> )	φ1.7 to φ3.0 mm	10 m max.

When bundling wire together or running wires through duct, take reduction rate of each wire allowable current into consideration. When ambient temperature is relatively high, wire product lifetime is reduced due to heat deterioration. In this case, please use Heat resistant Indoor PVC (HIV).

## Specification summary of I/O signals

Signal name	CN2 Pin number	Function summary
Phase origin monitor output (standard)	1	DSW1 MODE1=OFF
	2	Photocoupler is turned on when excitation phase is the origin (the state power supply is turned on).
Alarm output	1	DSW1 MODE1=ON
	2	Photocoupler is turned on when the driver is in the state of alarm being activated.
Auto-Current-Down canceling input	3	Inputting this signal (internal photocoupler is turned on) disables Auto-Current-Down function.
	4	
Step angle select input	5	Division numbers can be switched via SSEL-signal. Internal photocoupler is OFF ... Setting via rotary switch SS1 enabled Internal photocoupler is ON ... Setting via rotary switch SS2 enabled
	6	
CW pulse input (standard)	7	When in "2-input type", input the drive pulse that rotates in a CW direction.
	8	
Pulse train input	7	When in "1-input type", input the drive pulse train for motor rotation.
	8	
CCW pulse input (standard)	9	When in "2-input type", input the drive pulse that rotates in a CCW direction.
	10	
Rotational direction input	9	When in "1-input type", input the motor rotational direction signal. Internal photocoupler ON ... CW direction Internal photocoupler OFF ... CCW direction
	10	
Power down input	11	Inputting this signal (internal photocoupler is turned on) shuts off the current carried to motor.
	12	

As for the motor rotational direction, CW direction is regarded as the clockwise rotation, and CCW direction is regarded as the counterclockwise rotation by viewing the motor from output shaft side.

# Input Circuit Configuration of CW (CK), CCW (U/D)

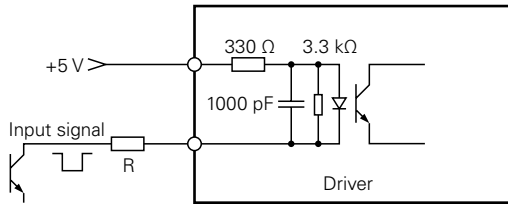

- Pulse duty 50% max.
- Maximum input frequency: 400 kpulse/s
- If the peak voltage of the input signal exceeds 5.5 V, please add an external current-limiting resistor R to limit the input current to around 10 mA. (Take the photocoupler forward voltage of 1.5 V into consideration.)

## Input signal specification

<Photocoupler type>

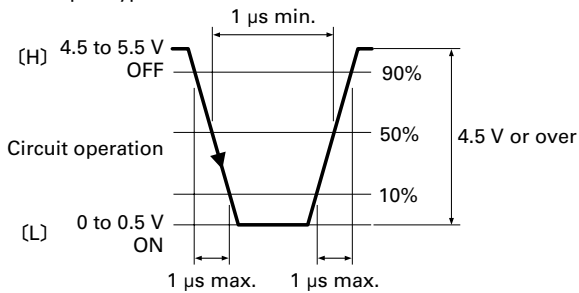

## Timing of command pulse

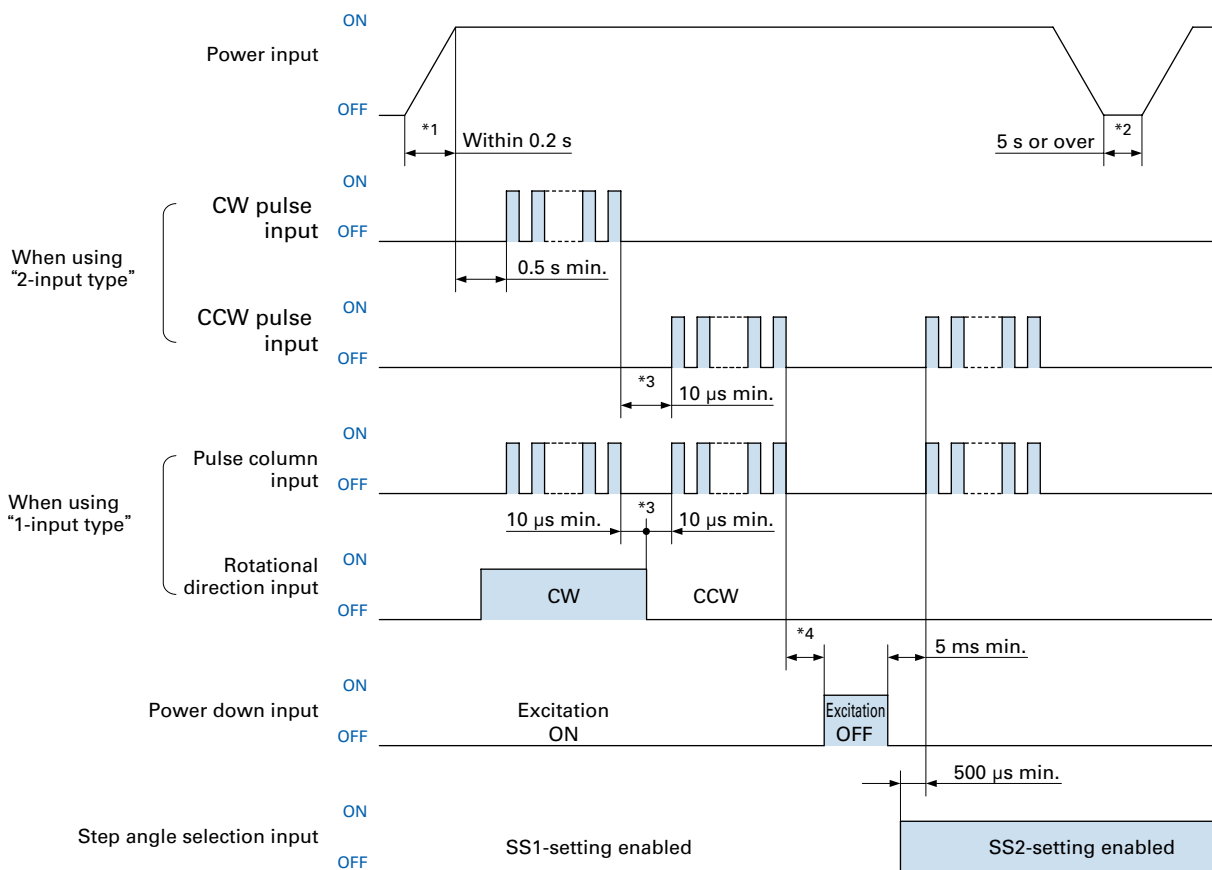

- The frequency of the power ON/OFF of the driver shall be 5 times/hour or less and 30 times/day or less.
- ■ indicates ON of photocoupler emitting side.
- When operating in double-input method, and then inputting pulse into CW, set CCW-side to OFF.  
When inputting pulse into CCW, set CW-side to OFF.
- For 1-input type, CK should be off when switching U/D input signal.

\*1 The time for the power supply to be established shall be within 0.2 seconds.

\*2 Re-turning on the power supply shall be at intervals of more than 5 seconds.

\*3 "10 μs or more" shown above is response time within driver internal circuit, so set the time such that motor can response.

\*4 Input power-down input signal in the state motor has been settled.

## Input Circuit Configuration of ACDOFF, SSEL, PD

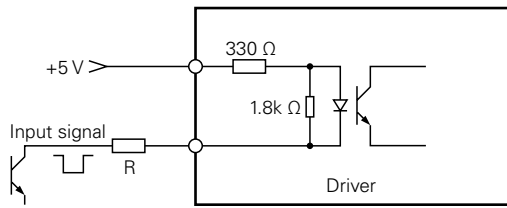

- If the peak voltage of the input signal exceeds 5.5 V, please add an external current-limiting resistor R to limit the input current to around 10 mA. (Take the photocoupler forward voltage of 1.5 V into consideration.)

## Output Signal Configuration of MON, AL

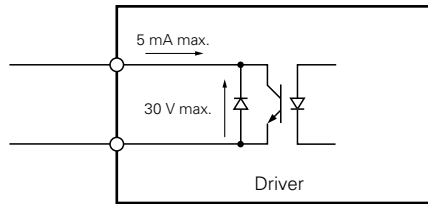

### MON output

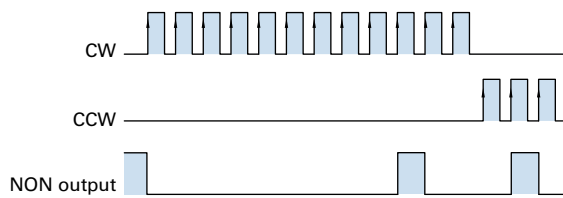

Example: 5-phase mode, 1 division (Full step)

- When the motor excitation phase is at the phase origin (power ON status), the photocoupler is ON.
- Inputting pulse turns on photocoupler every 7.2° of motor output axis from phase origin.
- Set command frequency to 50 kpulse/s or less to use phase origin monitor.
- Perform switching of division number via step-angle selection input signal (SSEL) with phase origin monitor output turned on and motor being stopped.
- Switching division number at the point other than excitation origin may cause that phase origin monitor output is not correctly output.

# DC Input Set Models/Drivers

## Full/half step

Set Model Configuration ▶ p. 84 Specifications/Characteristics Diagram ▶ pp. 85 to 99 Motor Dimensions ▶ pp. 71 to 74  
 Motor Specifications ▶ p. 75 Driver Dimensions ▶ p. 100 Driver Specifications ▶ p. 100

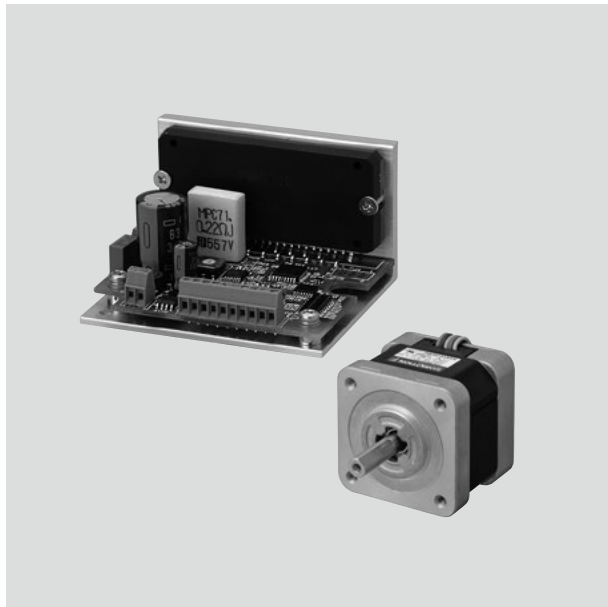

### Set configuration items RoHS

**Driver** CE c UL US RoHS

Model number: FS1D140P10  
 Power supply: 24/36 VDC  
 • The operation manual can be downloaded from our website.  
 • Drivers are available for separate purchase.

**Motor** New pentagon connection

Motor size: 28 mm sq., 42 mm sq., 60 mm sq., 86 mm sq.  
 • Prepare the cable according to the applicable wire sizes on p. 102.

## System Configuration Diagram

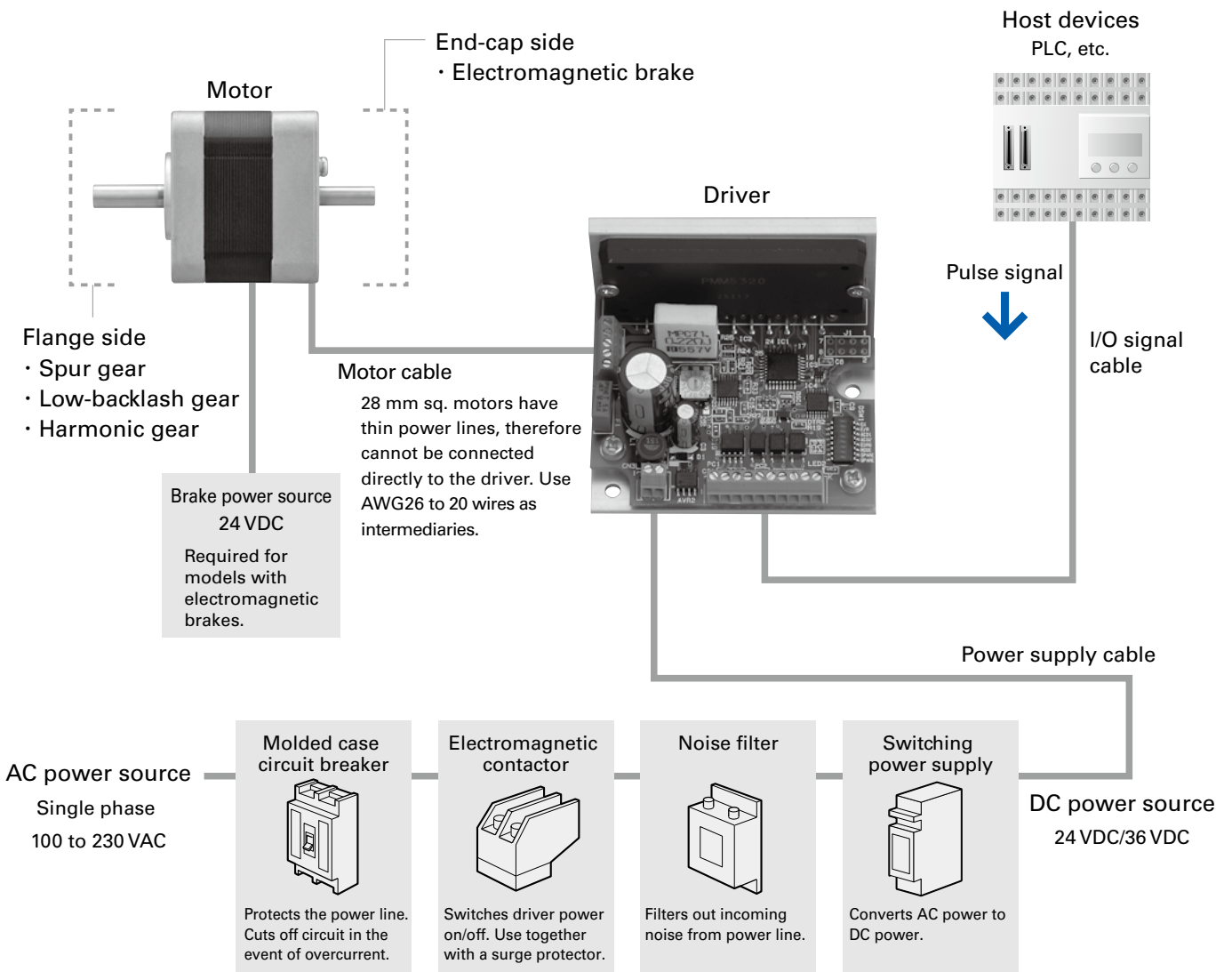



# Set Model Numbering Convention

Not every combination of the following codes or characters is available. Check the set model component details on the following page for the model number combinations, or contact us.

Example: This is a set model number for a DC input driver and motor (model number: SM5601-82CX A41).

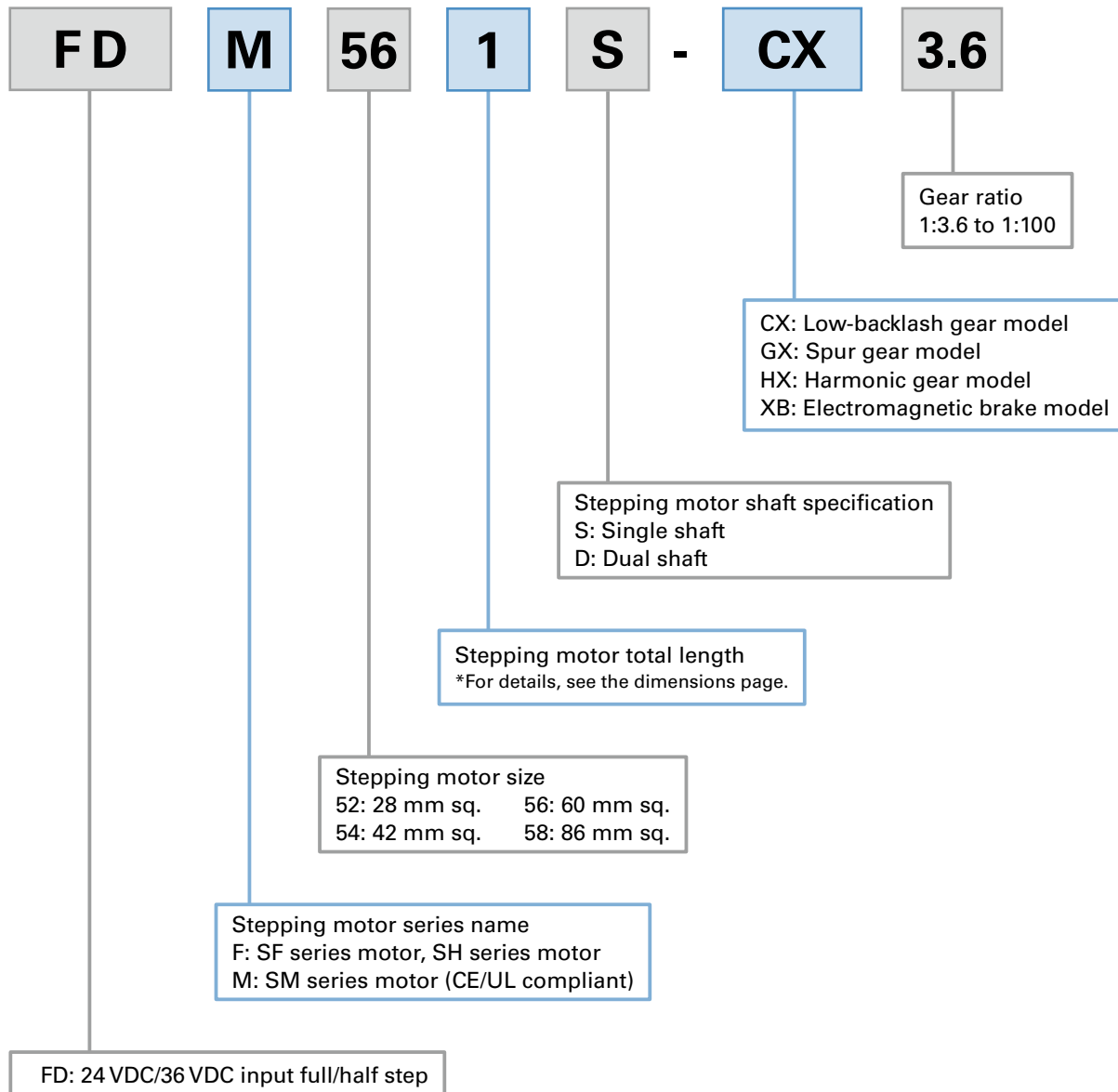

# Set Model Configuration

This set includes a driver and motor.

DC input driver model number: FS1D140P10

Basic step angle: 0.72°

Model	Motor size	Single shaft		Dual shaft		Rated current (A/phase)	Page			
		Set model number	Set configuration items	Set model number	Set configuration items		Specifi-cations	Dimen-sions		
			Motor		Motor					
Standard models	28 mm sq.	FDF521S	SH5281-7241	FDF521D	SH5281-7211	0.75	p. 85	p. 71		
		FDF525S	SH5285-7241	FDF525D	SH5285-7211		p. 85	p. 71		
	42 mm sq.	FDF541S	SF5421-8241	FDF541D	SF5421-8211	1.4	p. 85	p. 71		
		FDF542S	SF5422-8241	FDF542D	SF5422-8211		p. 85	p. 71		
	60 mm sq.	FDF543S	SF5423-8241	FDF543D	SF5423-8211	1.4	p. 86	p. 71		
		FDM561S	SM5601-8241	FDM561D	SM5601-8211		p. 86	p. 71		
		FDM562S	SM5602-8241	FDM562D	SM5602-8211		p. 86	p. 71		
	86 mm sq.	FDM563S	SM5603-8241	FDM563D	SM5603-8211	1.4	p. 86	p. 71		
		FDM581S	SM5861-8241	FDM581D	SM5861-8211		p. 87	p. 71		
	Low-backlash gear models	42 mm sq.	FDM582S	SM5862-8241	FDM582D	SM5862-8211	1.4	p. 87	p. 71	
			FDF541S-CX3.6	SF5421-82CXA41	FDF541D-CX3.6	SF5421-82CXA11		p. 88	p. 72	
			FDF541S-CX7.2	SF5421-82CXB41	FDF541D-CX7.2	SF5421-82CXB11		p. 88	p. 72	
FDF541S-CX10			SF5421-82CXE41	FDF541D-CX10	SF5421-82CXE11	p. 88		p. 72		
FDF541S-CX20			SF5421-82CXG41	FDF541D-CX20	SF5421-82CXG11	p. 88		p. 72		
FDF541S-CX30			SF5421-82CXJ41	FDF541D-CX30	SF5421-82CXJ11	p. 89		p. 72		
60 mm sq.		FDF541S-CX36	SF5421-82CXC41	FDF541D-CX36	SF5421-82CXC11	1.4	p. 89	p. 72		
		FDM561S-CX3.6	SM5601-82CXA41	FDM561D-CX3.6	SM5601-82CXA11		p. 89	p. 72		
		FDM561S-CX7.2	SM5601-82CXB41	FDM561D-CX7.2	SM5601-82CXB11		p. 89	p. 72		
		FDM561S-CX10	SM5601-82CXE41	FDM561D-CX10	SM5601-82CXE11		p. 90	p. 72		
		FDM561S-CX20	SM5601-82CXG41	FDM561D-CX20	SM5601-82CXG11		p. 90	p. 72		
		FDM561S-CX30	SM5601-82CXJ41	FDM561D-CX30	SM5601-82CXJ11		p. 90	p. 72		
86 mm sq.		FDM561S-CX36	SM5601-82CXC41	FDM561D-CX36	SM5601-82CXC11	1.4	p. 90	p. 72		
		FDM581S-CX3.6	SM5861-82CXA41	FDM581D-CX3.6	SM5861-82CXA11		p. 91	p. 72		
		FDM581S-CX7.2	SM5861-82CXB41	FDM581D-CX7.2	SM5861-82CXB11		p. 91	p. 72		
		FDM581S-CX10	SM5861-82CXE41	FDM581D-CX10	SM5861-82CXE11		p. 91	p. 72		
		FDM581S-CX20	SM5861-82CXG41	FDM581D-CX20	SM5861-82CXG11		p. 91	p. 72		
		FDM581S-CX30	SM5861-82CXJ41	FDM581D-CX30	SM5861-82CXJ11		p. 92	p. 72		
Spur gear models		28 mm sq.	FDM581S-CX36	SM5861-82CXC41	FDM581D-CX36	SM5861-82CXC11	1.4	p. 92	p. 72	
			FDF521S-GX3.6	SH5281-72GXA4	FDF521D-GX3.6	SH5281-72GXA1		0.75	p. 93	p. 71
			FDF521S-GX7.2	SH5281-72GXB4	FDF521D-GX7.2	SH5281-72GXB1			p. 93	p. 71
			FDF521S-GX10	SH5281-72GXE4	FDF521D-GX10	SH5281-72GXE1			p. 93	p. 71
			FDF521S-GX20	SH5281-72GXG4	FDF521D-GX20	SH5281-72GXG1			p. 93	p. 71
			FDF521S-GX30	SH5281-72GXJ4	FDF521D-GX30	SH5281-72GXJ1			p. 94	p. 71
	FDF521S-GX50	SH5281-72GXL4	FDF521D-GX50	SH5281-72GXL1	p. 94	p. 71				
	Harmonic gear models	28 mm sq.	FDF521S-HX50	SH5281-72HXL4	FDF521D-HX50	SH5281-72HXL1	0.75	p. 95	p. 72	
			FDF521S-HX100	SH5281-72HXM4	FDF521D-HX100	SH5281-72HXM1		p. 95	p. 72	
		42 mm sq.	FDF541S-HX30	SF5421-82HXJ41	FDF541D-HX30	SF5421-82HXJ11	1.4	p. 95	p. 73	
			FDF541S-HX50	SF5421-82HXL41	FDF541D-HX50	SF5421-82HXL11		p. 95	p. 73	
		60 mm sq.	FDF541S-HX100	SF5421-82HXM41	FDF541D-HX100	SF5421-82HXM11	1.4	p. 96	p. 73	
FDM561S-HX50			SM5601-82HXL41	FDM561D-HX50	SM5601-82HXL11	p. 96		p. 73		
86 mm sq.		FDM561S-HX100	SM5601-82HXM41	FDM561D-HX100	SM5601-82HXM11	1.4	p. 96	p. 73		
		FDM581S-HX50	SM5861-82HXL41	FDM581D-HX50	SM5861-82HXL11		p. 96	p. 73		
Electromagnetic brake models		42 mm sq.	FDM581S-HX100	SM5861-82HXM41	FDM581D-HX100	SM5861-82HXM11	1.4	p. 97	p. 73	
			FDF541S-XB	SF5421-82XB41	—	—		p. 98	p. 74	
			FDF542S-XB	SF5422-82XB41	—	—		p. 98	p. 74	
		60 mm sq.	FDF543S-XB	SF5423-82XB41	—	—	1.4	p. 98	p. 74	
	FDM561S-XB		SM5601-82XB41	—	—	p. 99		p. 74		
	FDM562S-XB		SM5602-82XB41	—	—	p. 99		p. 74		
	86 mm sq.	FDM563S-XB	SM5603-82XB41	—	—	1.4	p. 99	p. 74		
		FDM581S-XB	SM5861-82XB41	—	—		p. 99	p. 74		
		FDM582S-XB	SM5862-82XB41	—	—		p. 99	p. 74		

\* The motors above are lead wire types.

# Standard model

DC input Driver (Model number: FS1D140P10) + Standard motor

RoHS

Basic step angle: 0.72° Rated current: 28mm sq. Motor 0.75 A/phase, 42mm sq. to 86 mm sq. Motor 1.4 A/phase

Motor size		28 mm sq.		42 mm sq.	
		32 mm	51.5 mm	35 mm	41 mm
Single shaft	Set model number	<b>FDF521S</b>	<b>FDF525S</b>	<b>FDF541S</b>	<b>FDF542S</b>
	Configuration item: motor model number	SH5281-7241	SH5285-7241	SF5421-8241	SF5422-8241
Dual shaft	Set model number	<b>FDF521D</b>	<b>FDF525D</b>	<b>FDF541D</b>	<b>FDF542D</b>
	Configuration item: motor model number	SH5281-7211	SH5285-7211	SF5421-8211	SF5422-8211
Holding torque	N·m min.	0.041	0.078	0.125	0.185
Rotor inertia	×10 <sup>-4</sup> kg·m <sup>2</sup>	0.01	0.022	0.028	0.045
Motor mass *1	kg	0.11	0.2	0.24	0.31
Allowable thrust load	N	3	3	10	10
Allowable radial load *2	N	42	49	56	54

Note: 28 mm sq. motors have thin power lines, therefore cannot be connected directly to the driver. Use AWG26 to 20 wires as intermediaries.

\*1 Driver mass ▶ p. 100

\*2 The load point is at the tip of the output shaft.

## Characteristics diagram

With rubber coupling

Pull-out torque ——— Source current (no load) - - - - - Source current (load applied) ······  
fs: Maximum self-start frequency when not loaded ●

### FDF521S FDF521D

Winding current:  
0.75 A/phase

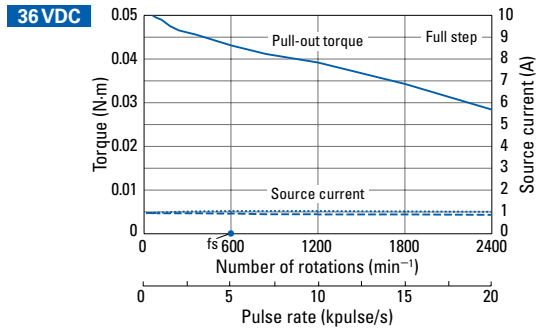
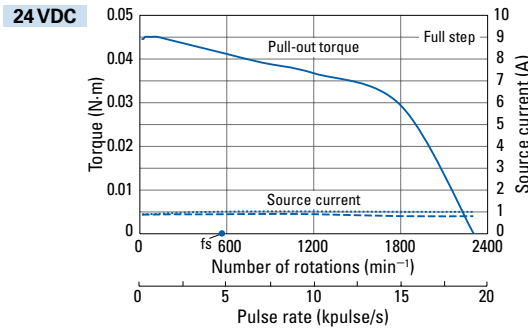

### FDF525S FDF525D

Winding current:  
0.75 A/phase

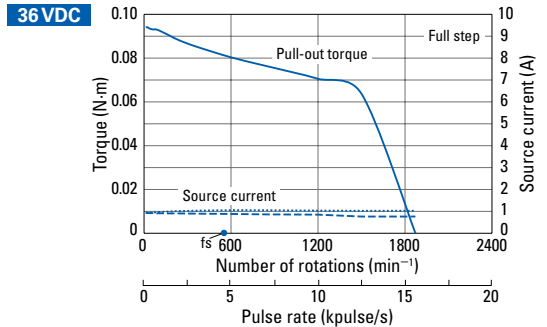
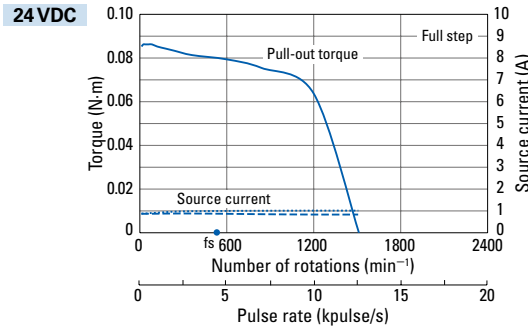

### FDF541S FDF541D

Winding current:  
1.4 A/phase

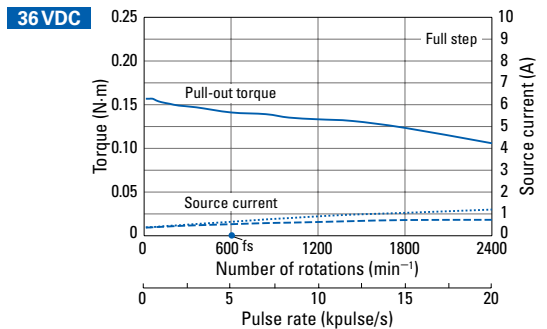
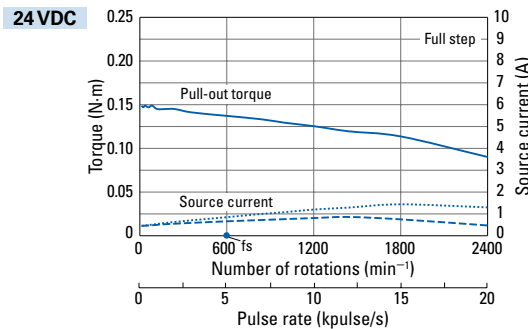

### FDF542S FDF542D

Winding current:  
1.4 A/phase

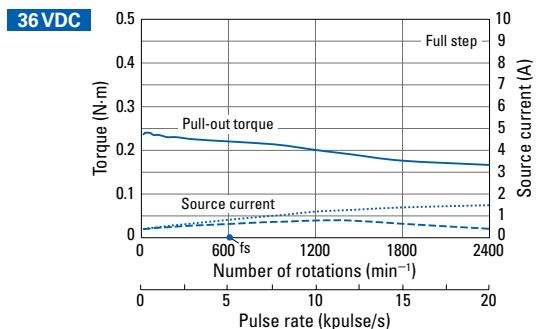
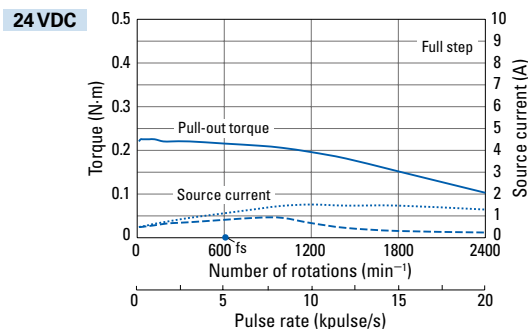

## Standard model DC input Driver (Model number: FS1D140P10) + Standard motor

RoHS

Basic step angle: 0.72° Rated current: 28mm sq. Motor 0.75 A/phase, 42mm sq. to 86 mm sq. Motor 1.4 A/phase

Motor size		42 mm sq.	60 mm sq.		
Motor length		49 mm	49 mm	60 mm	89 mm
Single shaft	Set model number	<b>FDF543S</b>	<b>FDM561S</b>	<b>FDM562S</b>	<b>FDM563S</b>
	Configuration item: motor model number	SF5423-8241	SM5601-8241	SM5602-8241	SM5603-8241
Dual shaft	Set model number	<b>FDF543D</b>	<b>FDM561D</b>	<b>FDM562D</b>	<b>FDM563D</b>
	Configuration item: motor model number	SF5423-8211	SM5601-8211	SM5602-8211	SM5603-8211
Holding torque	N·m min.	0.245	0.57	0.9	1.7
Rotor inertia	×10 <sup>-4</sup> kg·m <sup>2</sup>	0.056	0.2	0.31	0.6
Motor mass *1	kg	0.38	0.62	0.8	1.27
Allowable thrust load	N	10	20	20	20
Allowable radial load *2	N	52	191	183	170

\*1 Driver mass ▶ p. 100

\*2 The load point is at the tip of the output shaft.

### Characteristics diagram

Winding current: 1.4A/phase  
With rubber coupling

Pull-out torque ——— Source current (no load) - - - - - Source current (load applied) ······  
fs: Maximum self-start frequency when not loaded ●

**FDF543S**  
**FDF543D**

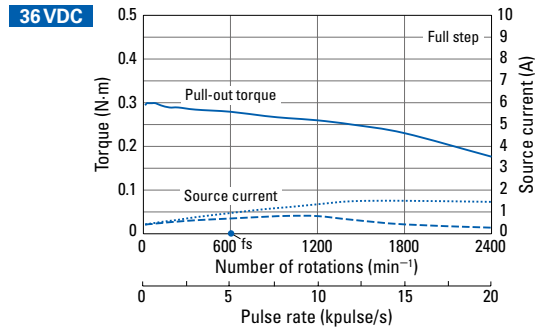
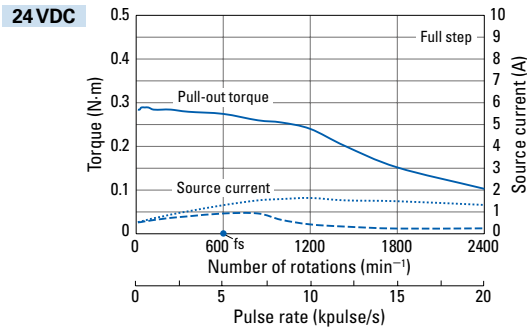

**FDM561S**  
**FDM561D**

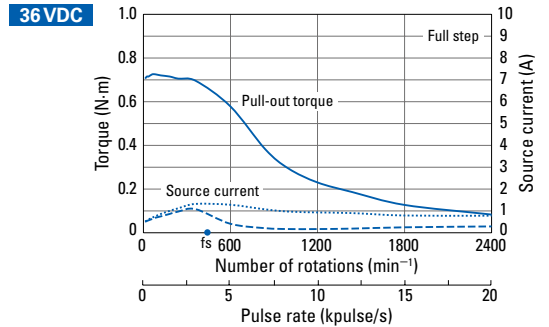
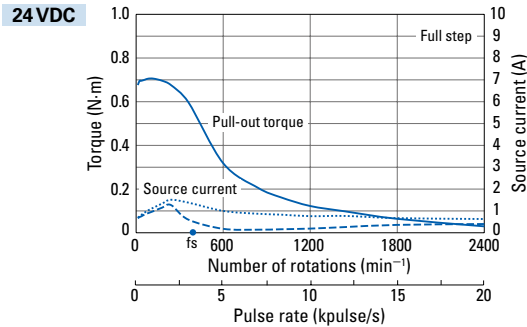

**FDM562S**  
**FDM562D**

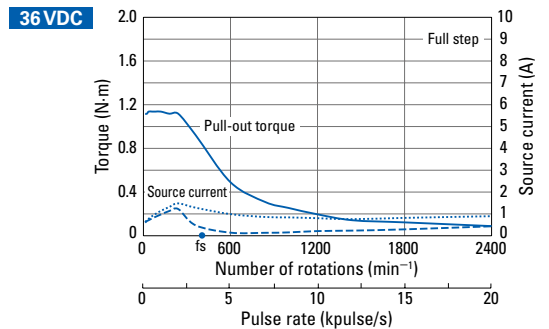
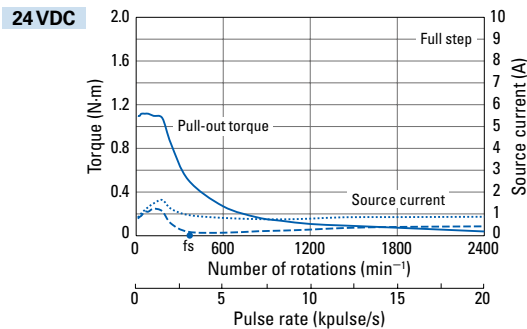

**FDM563S**  
**FDM563D**

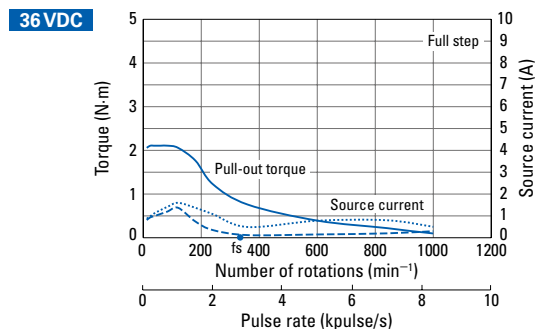
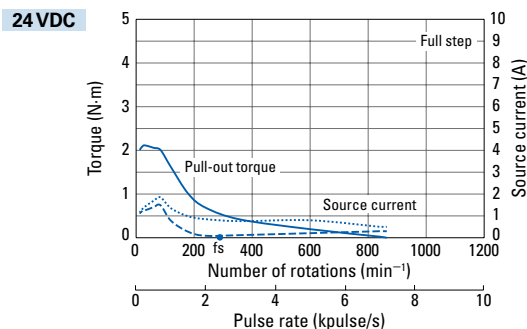

# Standard model DC input Driver (Model number: FS1D140P10) + Standard motor

RoHS

Basic step angle: 0.72° Rated current: 28mm sq. Motor 0.75 A/phase, 42mm sq. to 86 mm sq. Motor 1.4 A/phase

Motor size		86 mm sq.	
Motor length		66 mm	96.5 mm
Single shaft	Set model number	<b>FDM581S</b>	<b>FDM582S</b>
	Configuration item: motor model number	SM5861-8241	SM5862-8241
Dual shaft	Set model number	<b>FDM581D</b>	<b>FDM582D</b>
	Configuration item: motor model number	SM5861-8211	SM5862-8211
Holding torque	N·m min.	2.3	4.4
Rotor inertia	×10 <sup>-4</sup> kg·m <sup>2</sup>	1.48	3
Motor mass *1	kg	1.75	2.9
Allowable thrust load	N	60	60
Allowable radial load *2	N	200	200

\*1 Driver mass ▶ p. 100

\*2 The load point is at the tip of the output shaft.

## Characteristics diagram

Winding current: 1.4A/phase  
With rubber coupling

Pull-out torque ———

Source current (no load) - - - - -

Source current (load applied) ······

fs: Maximum self-start frequency when not loaded ●

**FDM581S**  
**FDM581D**

24 VDC

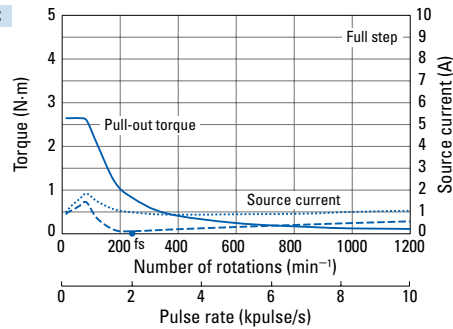

36 VDC

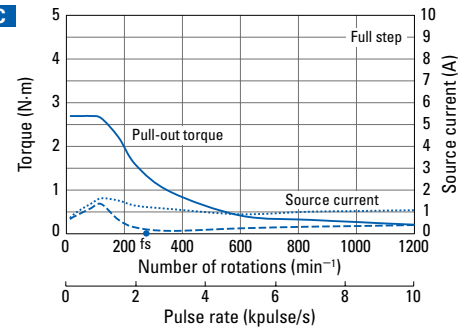

**FDM582S**  
**FDM582D**

24 VDC

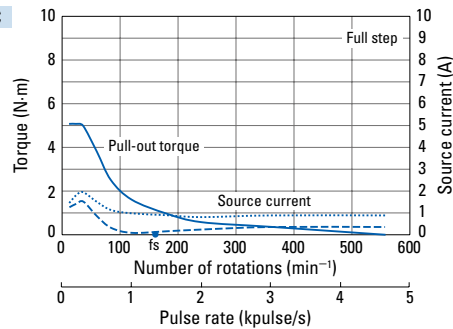

36 VDC

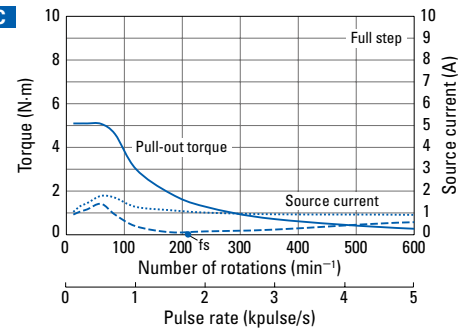

Low-backlash gear model

DC input Driver (Model number: FS1D140P10) + Motor with low-backlash gear

RoHS

Rated current: 1.4 A/phase

Motor size		42 mm sq. 65.4 mm			
Motor + gear length					
Single shaft	Set model number Configuration item: motor model number	<b>FD541S-CX3.6</b> SF5421-82CXA41	<b>FD541S-CX7.2</b> SF5421-82CXB41	<b>FD541S-CX10</b> SF5421-82CXE41	<b>FD541S-CX20</b> SF5421-82CXG41
Dual shaft	Set model number Configuration item: motor model number	<b>FD541D-CX3.6</b> SF5421-82CXA11	<b>FD541D-CX7.2</b> SF5421-82CXB11	<b>FD541D-CX10</b> SF5421-82CXE11	<b>FD541D-CX20</b> SF5421-82CXG11
Allowable torque	N·m	0.343	0.686	1	1.5
Rotor inertia	$\times 10^{-4}$ kg·m <sup>2</sup>	0.028	0.028	0.028	0.028
Rated current	A/phase	1.4	1.4	1.4	1.4
Basic step angle	°	0.2	0.1	0.072	0.036
Gear ratio	—	1:3.6	1:7.2	1:10	1:20
Backlash	° or less	0.6	0.4	0.35	0.25
Allowable speed	min <sup>-1</sup>	500	250	180	90
Motor mass *1	kg	0.37	0.37	0.37	0.37
Allowable thrust load	N	15	15	15	15
Allowable radial load *2	N	20	20	20	20

Note: Directions of motor rotation and gear output shaft rotation are the same for models with reduction ratios 1:3.6, 1:7.2 and 1:10, and opposite for reduction ratios 1:20, 1:30, and 1:36.

\*1 Driver mass ▶ p. 100

\*2 When load is applied at 1/3 length from output shaft edge.

Characteristics diagram

Winding current: 1.4A/phase

Allowable torque ——— Source current (no load) - - - - -  
fs: Maximum self-start frequency when not loaded ● Source current (load applied) ······

**FD541S-CX3.6**  
**FD541D-CX3.6**

**24 VDC**

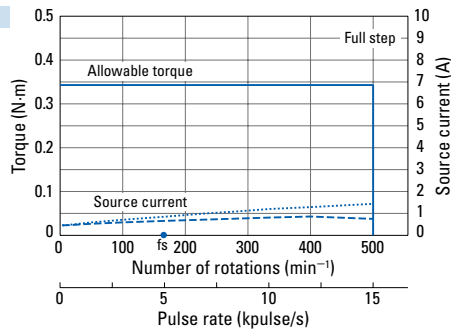

**36 VDC**

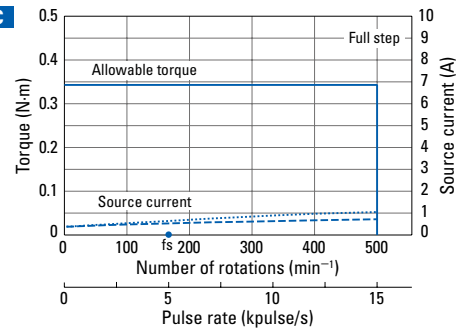

**FD541S-CX7.2**  
**FD541D-CX7.2**

**24 VDC**

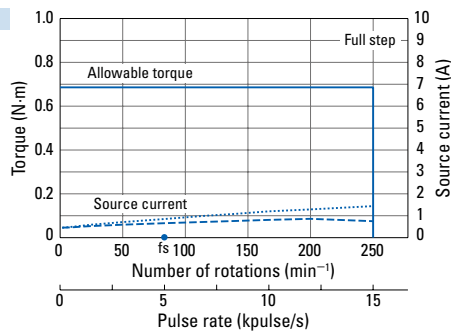

**36 VDC**

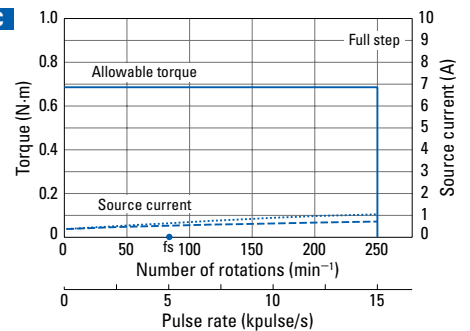

**FD541S-CX10**  
**FD541D-CX10**

**24 VDC**

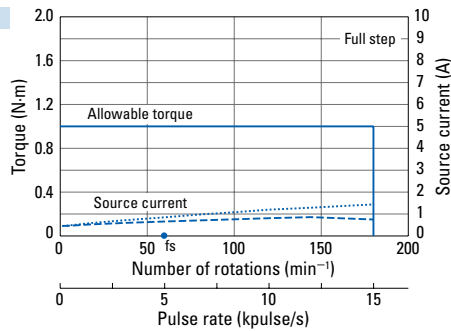

**36 VDC**

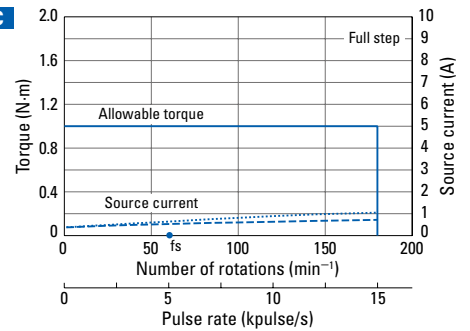

**FD541S-CX20**  
**FD541D-CX20**

**24 VDC**

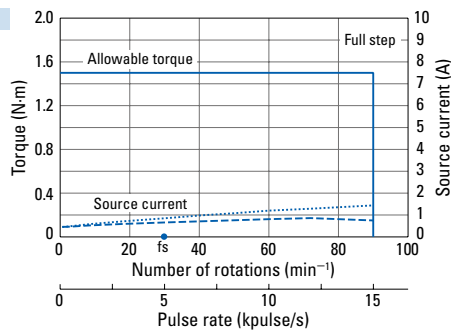

**36 VDC**

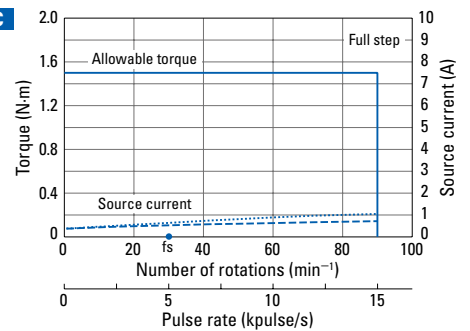

# Low-backlash gear model

DC input Driver (Model number: FS1D140P10) + Motor with low-backlash gear

RoHS

Rated current: 1.4 A/phase

Motor size		42 mm sq.		60 mm sq.	
		65.4 mm		94.8 mm	
Motor + gear length					
Single shaft	Set model number	<b>FD</b> F541S-CX30	<b>FD</b> F541S-CX36	<b>FD</b> M561S-CX3.6	<b>FD</b> M561S-CX7.2
	Configuration item: motor model number	SF5421-82CXJ41	SF5421-82CXK41	SM5601-82CXA41	SM5601-82CXB41
Dual shaft	Set model number	<b>FD</b> F541D-CX30	<b>FD</b> F541D-CX36	<b>FD</b> M561D-CX3.6	<b>FD</b> M561D-CX7.2
	Configuration item: motor model number	SF5421-82CXJ11	SF5421-82CXK11	SM5601-82CXA11	SM5601-82CXB11
Allowable torque	N·m	1.5	1.5	1.25	2.5
Rotor inertia	$\times 10^{-4}$ kg·m <sup>2</sup>	0.028	0.028	0.2	0.2
Rated current	A/phase	1.4	1.4	1.4	1.4
Basic step angle	°	0.024	0.02	0.2	0.1
Gear ratio	—	1:30	1:36	1:3.6	1:7.2
Backlash	° or less	0.25	0.25	0.55	0.25
Allowable speed	min <sup>-1</sup>	60	50	500	250
Motor mass *1	kg	0.37	0.37	1	1
Allowable thrust load	N	15	15	30	30
Allowable radial load *2	N	20	20	100	100

Note: Directions of motor and gear output shaft rotation for 42 mm sq. models are the same for models with reduction ratios 1:3.6, 1:7.2 and 1:10, and opposite for reduction ratios 1:20, 1:30 and 1:36. For 60 mm sq. models, rotation directions are the same for models with reduction ratios 1:3.6 and 1:7.2, and opposite for reduction ratios 1:10, 1:20, 1:30 and 1:36.

\*1 Driver mass ▶ p. 100

\*2 When load is applied at 1/3 length from output shaft edge.

## Characteristics diagram

Winding current: 1.4A/phase

Allowable torque ——— Source current (no load) - - - - - Source current (load applied) ······  
fs: Maximum self-start frequency when not loaded ●

**FD**F541S-CX30  
**FD**F541D-CX30

24 VDC

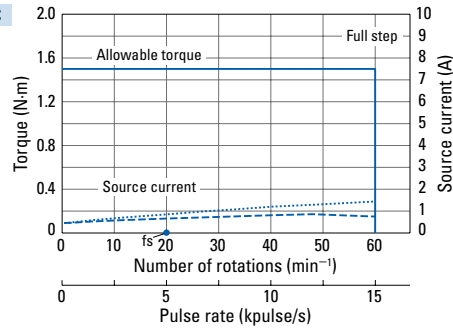

36 VDC

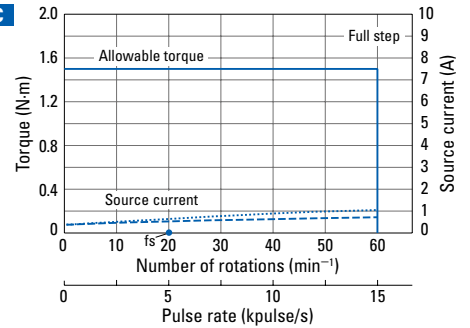

**FD**F541S-CX36  
**FD**F541D-CX36

24 VDC

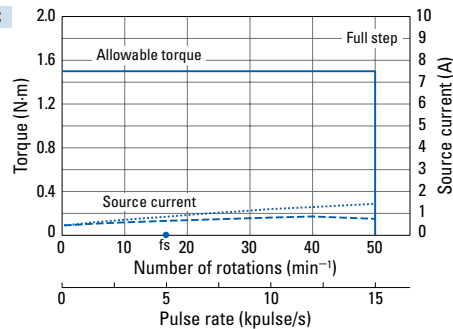

36 VDC

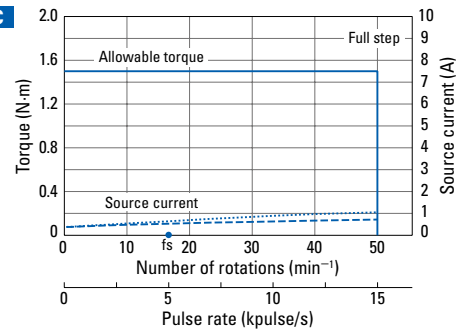

**FD**M561S-CX3.6  
**FD**M561D-CX3.6

24 VDC

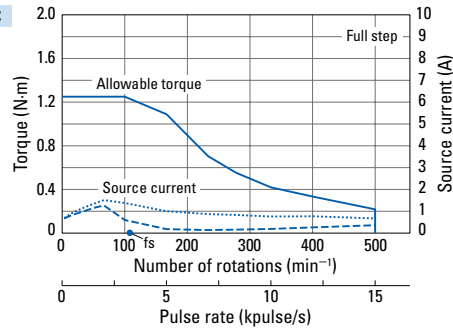

36 VDC

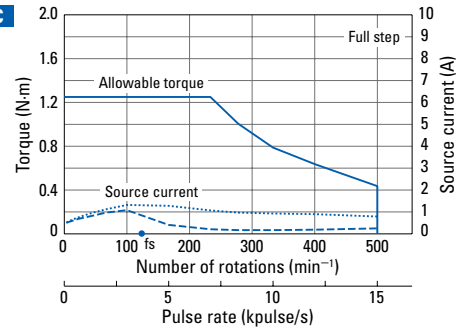

**FD**M561S-CX7.2  
**FD**M561D-CX7.2

24 VDC

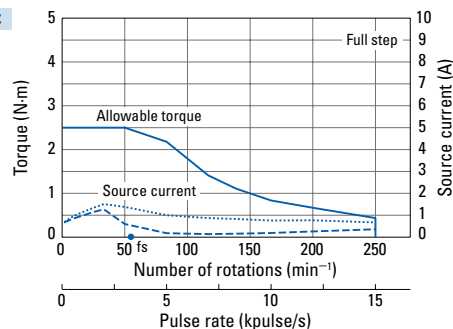

36 VDC

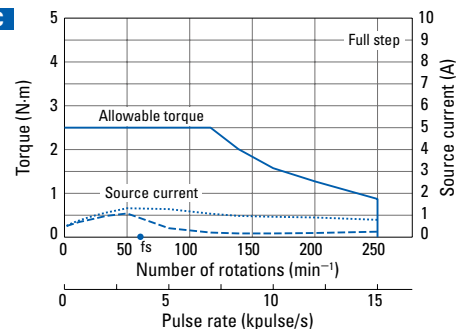



Low-backlash gear model

DC input Driver (Model number: FS1D140P10) + Motor with low-backlash gear

RoHS

Rated current: 1.4 A/phase

		60 mm sq. 94.8 mm			
		FDM561S-CX10 SM5601-82CXE41	FDM561S-CX20 SM5601-82CXG41	FDM561S-CX30 SM5601-82CXJ41	FDM561S-CX36 SM5601-82CXK41
Motor size		60 mm sq. 94.8 mm			
Motor + gear length		94.8 mm			
Single shaft	Set model number Configuration item: motor model number	FDM561S-CX10 SM5601-82CXE41	FDM561S-CX20 SM5601-82CXG41	FDM561S-CX30 SM5601-82CXJ41	FDM561S-CX36 SM5601-82CXK41
Dual shaft	Set model number Configuration item: motor model number	FDM561D-CX10 SM5601-82CXE11	FDM561D-CX20 SM5601-82CXG11	FDM561D-CX30 SM5601-82CXJ11	FDM561D-CX36 SM5601-82CXK11
Allowable torque	N·m	3	3.5	4	4
Rotor inertia	$\times 10^{-4}$ kg·m <sup>2</sup>	0.2	0.2	0.2	0.2
Rated current	A/phase	1.4	1.4	1.4	1.4
Basic step angle	°	0.072	0.036	0.024	0.02
Gear ratio	—	1:10	1:20	1:30	1:36
Backlash	° or less	0.25	0.17	0.17	0.17
Allowable speed	min <sup>-1</sup>	180	90	60	50
Motor mass *1	kg	1	1	1	1
Allowable thrust load	N	30	30	30	30
Allowable radial load *2	N	100	100	100	100

Note: Directions of motor rotation and gear output shaft rotation are the same for models with reduction ratios 1:3.6 and 1:7.2, and opposite for reduction ratios 1:10, 1:20, 1:30 and 1:36.

\*1 Driver mass ▶ p. 100

\*2 When load is applied at 1/3 length from output shaft edge.

Characteristics diagram

Winding current: 1.4A/phase

Allowable torque — Source current (no load) - - - - - Source current (load applied) ······  
fs: Maximum self-start frequency when not loaded ●

FDM561S-CX10  
FDM561D-CX10

24 VDC

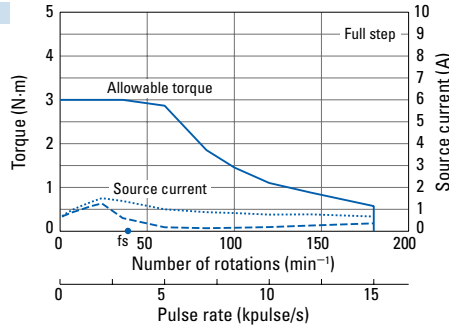

36 VDC

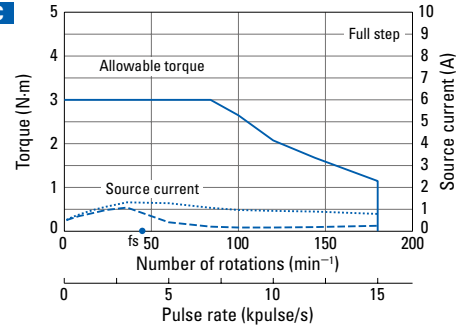

FDM561S-CX20  
FDM561D-CX20

24 VDC

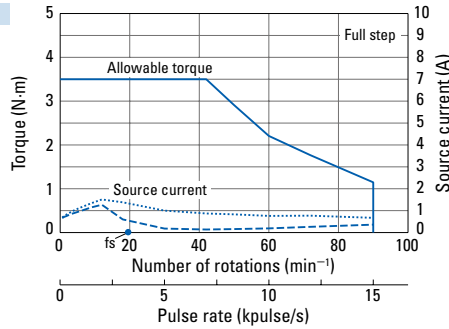

36 VDC

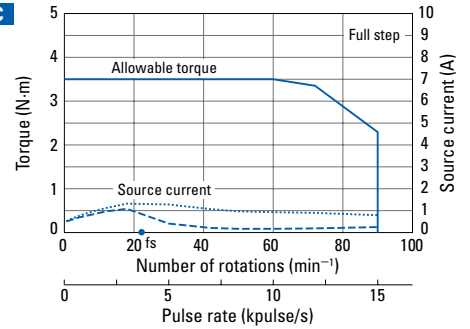

FDM561S-CX30  
FDM561D-CX30

24 VDC

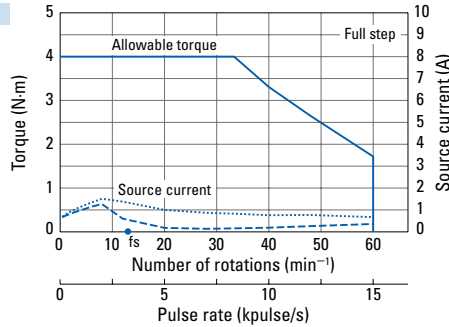

36 VDC

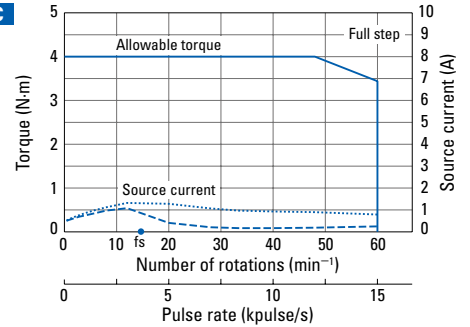

FDM561S-CX36  
FDM561D-CX36

24 VDC

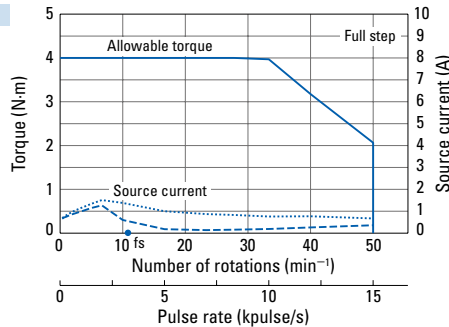

36 VDC

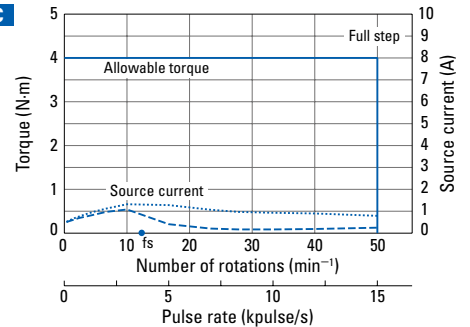

# Low-backlash gear model

DC input Driver (Model number: FS1D140P10) + Motor with low-backlash gear

RoHS

Rated current: 1.4 A/phase

Motor size		86 mm sq. (angular dimension 90 mm sq.)			
		131 mm			
Motor + gear length					
Single shaft	Set model number	FDM581S-CX3.6	FDM581S-CX7.2	FDM581S-CX10	FDM581S-CX20
	Configuration item: motor model number	SM5861-82CXA41	SM5861-82CXB41	SM5861-82CXE41	SM5861-82CXG41
Dual shaft	Set model number	FDM581D-CX3.6	FDM581D-CX7.2	FDM581D-CX10	FDM581D-CX20
	Configuration item: motor model number	SM5861-82CXA11	SM5861-82CXB11	SM5861-82CXE11	SM5861-82CXG11
Allowable torque	N·m	4.5	9	9	12
Rotor inertia	$\times 10^{-4} \text{kg}\cdot\text{m}^2$	1.48	1.48	1.48	1.48
Rated current	A/phase	1.4	1.4	1.4	1.4
Basic step angle	$^\circ$	0.2	0.1	0.072	0.036
Gear ratio	—	1:3.6	1:7.2	1:10	1:20
Backlash	$^\circ$ or less	0.35	0.22	0.22	0.15
Allowable speed	$\text{min}^{-1}$	500	250	180	90
Motor mass *1	kg	2.95	2.95	2.95	2.95
Allowable thrust load	N	60	60	60	60
Allowable radial load *2	N	300	300	300	300

Note: Directions of motor rotation and gear output shaft rotation are the same for models with reduction ratios 1:3.6 and 1:7.2, and opposite for reduction ratios 1:10, 1:20, 1:30 and 1:36.

\*1 Driver mass ▶ p. 100

\*2 When load is applied at 1/3 length from output shaft edge.

## Characteristics diagram

Winding current: 1.4A/phase

Allowable torque ——— Source current (no load) - - - - - Source current (load applied) ······  
fs: Maximum self-start frequency when not loaded ●

**FDM581S-CX3.6**  
**FDM581D-CX3.6**

**24 VDC**

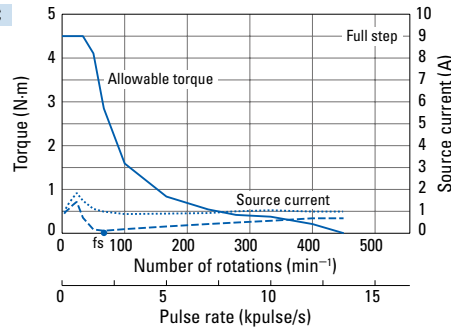

**36 VDC**

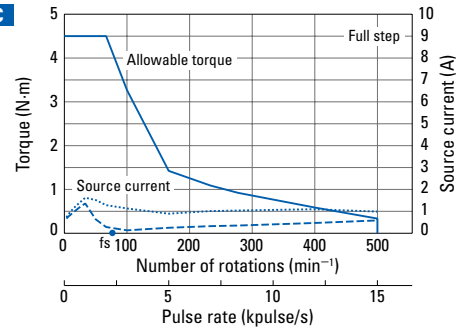

**FDM581S-CX7.2**  
**FDM581D-CX7.2**

**24 VDC**

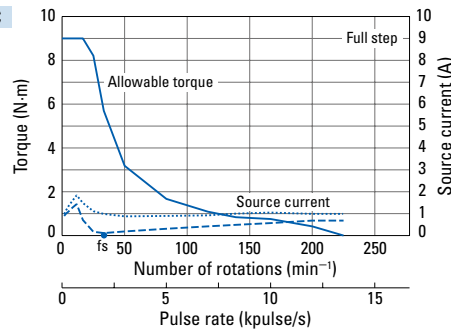

**36 VDC**

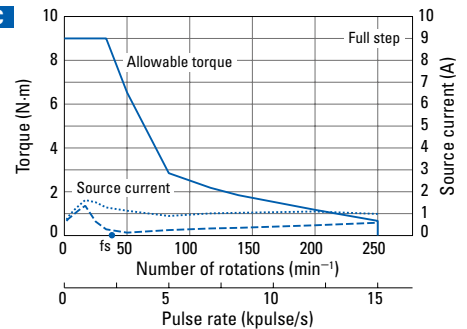

**FDM581S-CX10**  
**FDM581D-CX10**

**24 VDC**

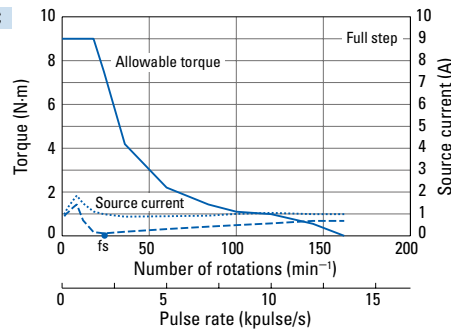

**36 VDC**

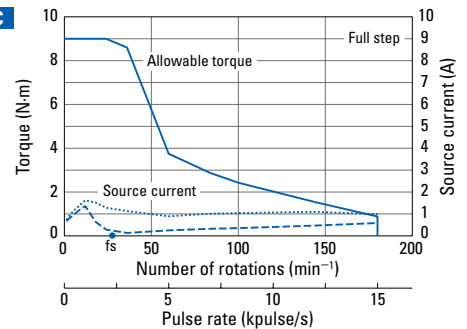

**FDM581S-CX20**  
**FDM581D-CX20**

**24 VDC**

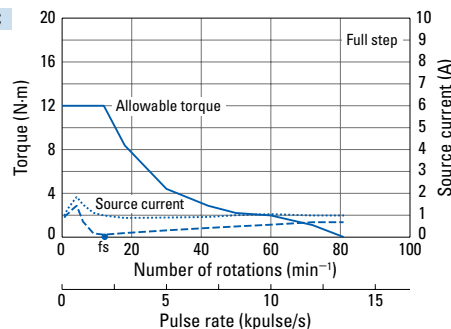

**36 VDC**

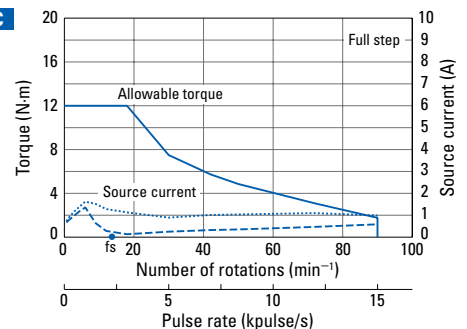

## Low-backlash gear model

DC input Driver (Model number: FS1D140P10) + Motor with low-backlash gear

RoHS

Rated current: 1.4 A/phase

Motor size		86 mm sq. (angular dimension 90 mm sq.)	
Motor + gear length		131 mm	
Single shaft	Set model number	FDM581S-CX30	FDM581S-CX36
	Configuration item: motor model number	SM5861-82CXJ41	SM5861-82CXK41
Dual shaft	Set model number	FDM581D-CX30	FDM581D-CX36
	Configuration item: motor model number	SM5861-82CXJ11	SM5861-82CXK11
Allowable torque	N·m	12	12
Rotor inertia	$\times 10^{-4} \text{kg}\cdot\text{m}^2$	1.48	1.48
Rated current	A/phase	1.4	1.4
Basic step angle	°	0.024	0.02
Gear ratio	—	1:30	1:36
Backlash	° or less	0.15	0.13
Allowable speed	$\text{min}^{-1}$	60	50
Motor mass *1	kg	2.95	2.95
Allowable thrust load	N	60	60
Allowable radial load *2	N	300	300

Note: Directions of motor rotation and gear output shaft rotation are the same for models with reduction ratios 1:3.6 and 1:7.2, and opposite for reduction ratios 1:10, 1:20, 1:30 and 1:36.

\*1 Driver mass ▶ p. 100

\*2 When load is applied at 1/3 length from output shaft edge.

## Characteristics diagram

Winding current: 1.4A/phase

Allowable torque ——— Source current (no load) - - - - -  
fs: Maximum self-start frequency when not loaded ●

Source current (load applied) ······

**FDM581S-CX30**  
**FDM581D-CX30**

**24 VDC**

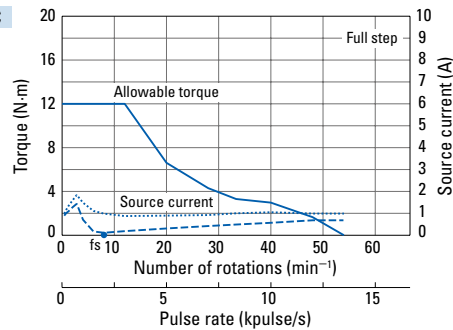

**36 VDC**

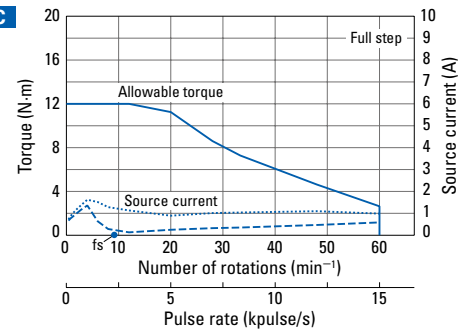

**FDM581S-CX36**  
**FDM581D-CX36**

**24 VDC**

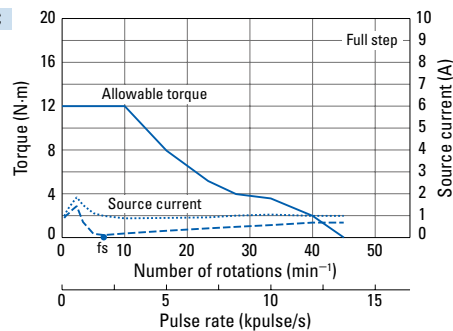

**36 VDC**

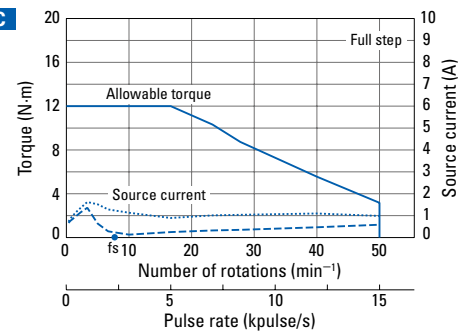

# Spur gear model

DC input Driver (Model number: FS1D140P10) + Motor with spur gear

RoHS

Rated current: 0.75 A/phase

		28 mm sq. 61.5 mm			
		FD521S-GX3.6 SH5281-72GXA4	FD521S-GX7.2 SH5281-72GXB4	FD521S-GX10 SH5281-72GXE4	FD521S-GX20 SH5281-72GXG4
Motor size		28 mm sq. 61.5 mm			
Motor + gear length					
Single shaft	Set model number Configuration item: motor model number	FD521S-GX3.6 SH5281-72GXA4	FD521S-GX7.2 SH5281-72GXB4	FD521S-GX10 SH5281-72GXE4	FD521S-GX20 SH5281-72GXG4
Dual shaft	Set model number Configuration item: motor model number	FD521D-GX3.6 SH5281-72GXA1	FD521D-GX7.2 SH5281-72GXB1	FD521D-GX10 SH5281-72GXE1	FD521D-GX20 SH5281-72GXG1
Allowable torque	N·m	0.1	0.15	0.2	0.35
Rotor inertia	$\times 10^{-4}$ kg·m <sup>2</sup>	0.01	0.01	0.01	0.01
Rated current	A/phase	0.75	0.75	0.75	0.75
Basic step angle	°	0.2	0.1	0.072	0.036
Gear ratio	—	1:3.6	1:7.2	1:10	1:20
Backlash	° or less	2	2	2	1.5
Allowable speed	min <sup>-1</sup>	800	400	300	150
Motor mass *1	kg	0.17	0.17	0.17	0.17
Allowable thrust load	N	10	10	10	10
Allowable radial load *2	N	15	15	15	15

Note: Directions of motor rotation and gear output shaft rotation are the same for models with reduction ratios 1:3.6, 1:7.2, 1:20, 1:30 and 1:50, and opposite for reduction ratios 1:10.  
Note: 28 mm sq. motors have thin power lines, therefore cannot be connected directly to the driver. Use AWG26 to 20 wires as intermediaries.

\*1 Driver mass ▶ p. 100

\*2 When load is applied at 1/3 length from output shaft edge.

## Characteristics diagram

Winding current: 0.75A/phase

Allowable torque ——— Source current (no load) - - - - - Source current (load applied) ······  
fs: Maximum self-start frequency when not loaded ●

**FD521S-GX3.6**  
**FD521D-GX3.6**

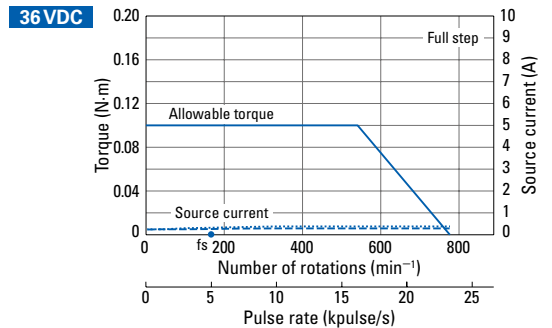
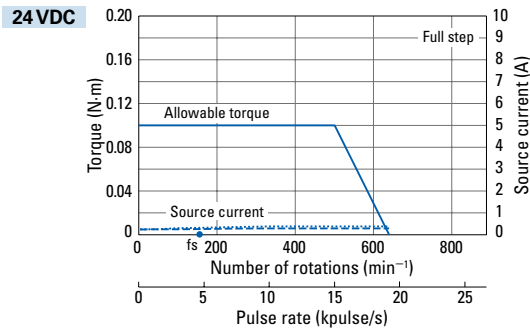

**FD521S-GX7.2**  
**FD521D-GX7.2**

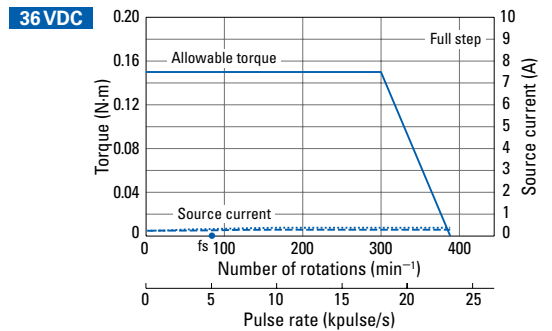
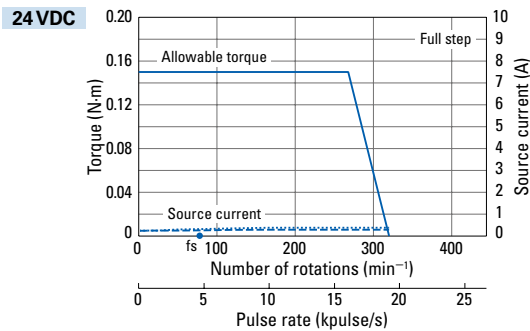

**FD521S-GX10**  
**FD521D-GX10**

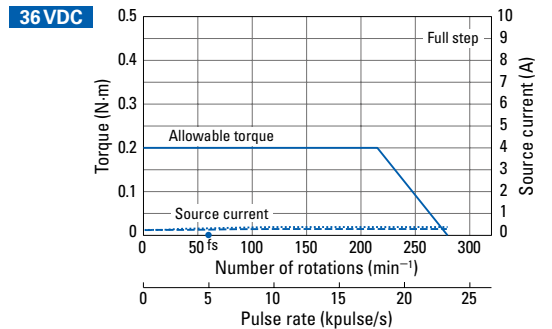
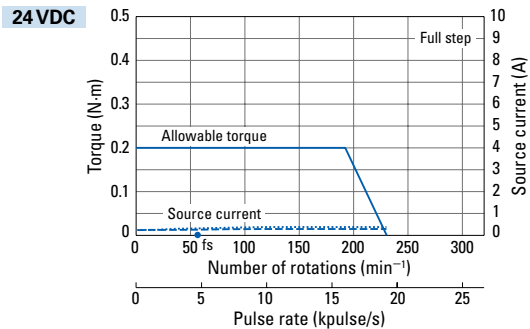

**FD521S-GX20**  
**FD521D-GX20**

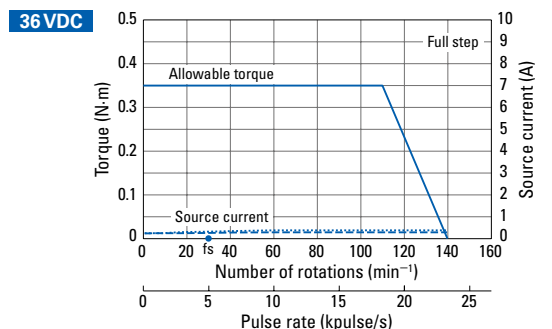
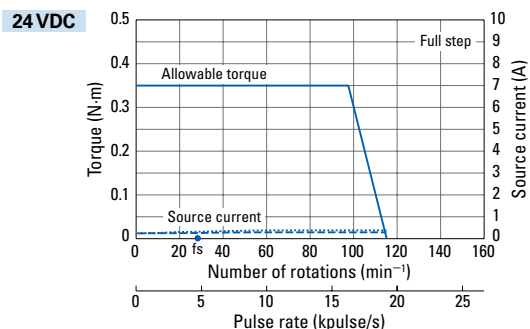

System Configuration Diagram ▶ p. 82 Set Model Configuration ▶ p. 84 Motor Dimensions ▶ pp. 71 to 74 Driver Dimensions ▶ p. 100

If allowable torque is exceeded when using a motor with spur gears, the gears may be damaged. When selecting a motor, ensure that its allowable torque will not be exceeded. Data is measured under the trial conditions of SANYO DENKI. Driving torque may vary according to actual machine precision.

## Spur gear model DC input Driver (Model number: FS1D140P10) + Motor with spur gear

RoHS

Rated current: 0.75 A/phase

		28 mm sq. 61.5 mm	
Motor size			
Motor + gear length			
Single shaft	Set model number	<b>FD521S-GX30</b>	<b>FD521S-GX50</b>
	Configuration item: motor model number	SH5281-72GXJ4	SH5281-72GXL4
Dual shaft	Set model number	<b>FD521D-GX30</b>	<b>FD521D-GX50</b>
	Configuration item: motor model number	SH5281-72GXJ1	SH5281-72GXL1
Allowable torque	N·m	0.5	0.5
Rotor inertia	$\times 10^{-4}$ kg·m <sup>2</sup>	0.01	0.01
Rated current	A/phase	0.75	0.75
Basic step angle	°	0.024	0.0144
Gear ratio	—	1:30	1:50
Backlash	° or less	1.5	1.5
Allowable speed	min <sup>-1</sup>	100	60
Motor mass *1	kg	0.17	0.17
Allowable thrust load	N	10	10
Allowable radial load *2	N	15	15

Note: Directions of motor rotation and gear output shaft rotation are the same for models with reduction ratios 1:3.6, 1:7.2, 1:20, 1:30 and 1:50, and opposite for reduction ratios 1:10.  
 Note: 28 mm sq. motors have thin power lines, therefore cannot be connected directly to the driver. Use AWG26 to 20 wires as intermediaries.

\*1 Driver mass ▶ p. 100

\*2 When load is applied at 1/3 length from output shaft edge.

### Characteristics diagram

Winding current: 0.75A/phase

Allowable torque ——— Source current (no load) - - - - -  
 fs: Maximum self-start frequency when not loaded ●

Source current (load applied) ······

**FD521S-GX30**  
**FD521D-GX30**

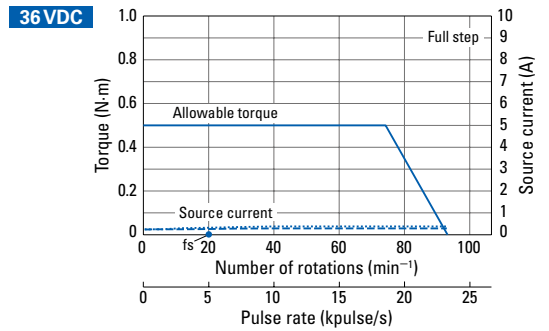
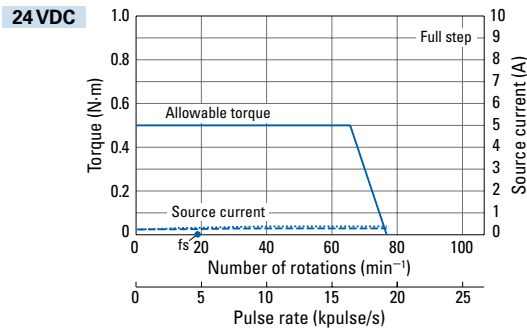

**FD521S-GX50**  
**FD521D-GX50**

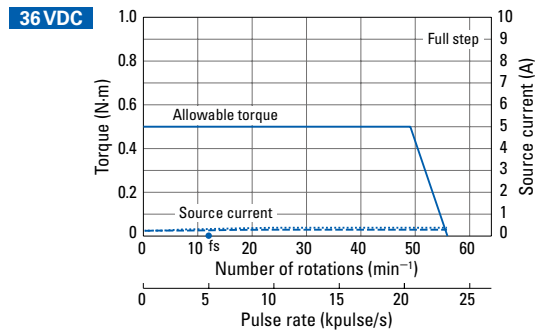
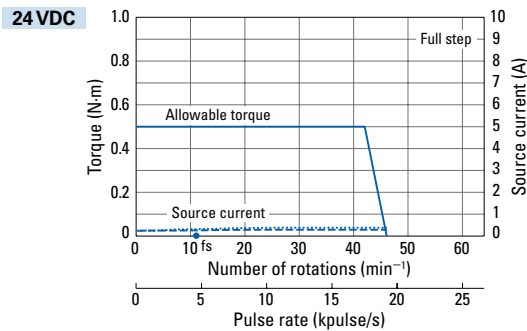

# Harmonic gear model

DC input Driver (Model number: FS1D140P10) + Motor with harmonic gear

RoHS

Rated current: 28 mm sq. Motor 0.75 A/phase, 42 mm sq. to 86 mm sq. Motor 1.4 A/phase

Motor size		28 mm sq. (angular dimension 33 mm sq.)		42 mm sq.	
Motor + gear length		70.7 mm		74.4 mm	
Single shaft	Set model number Configuration item: motor model number	FD521S-HX50 SH5281-72HXL4	FD521S-HX100 SH5281-72HXM4	FD541S-HX30 SF5421-82HXJ41	FD541S-HX50 SF5421-82HXL41
Dual shaft	Set model number Configuration item: motor model number	FD521D-HX50 SH5281-72HXL1	FD521D-HX100 SH5281-72HXM1	FD541D-HX30 SF5421-82HXJ11	FD541D-HX50 SF5421-82HXL11
Allowable torque	N·m	1.5	2	2.2	3.5
Momentary allowable torque	N·m	2.6	3.6	4.5	8.3
Rotor inertia	$\times 10^{-4}$ kg·m <sup>2</sup>	0.013	0.013	0.04	0.04
Rated current	A/phase	0.75	0.75	1.4	1.4
Basic step angle	°	0.0144	0.0072	0.024	0.0144
Gear ratio	—	1:50	1:100	1:30	1:50
Hysteresis loss	Arc min or less	-	-	3.6	2.4
Lost motion	Arc min	0.4 to 3 ( $\pm 0.06$ N·m)		-	-
Allowable speed	min <sup>-1</sup>	70	35	116	70
Motor mass *1	kg	0.22	0.22	0.44	0.44
Allowable thrust load	N	100	100	1150	1150
Allowable radial load *2	N	160	160	275	275

Note: The motor and gear output shaft rotate in the opposite direction. Note: 28 mm sq. motors have thin power lines, therefore cannot be connected directly to the driver. Use AWG26 to 20 wires as intermediaries.

\*1 Driver mass ▶ p. 100 \*2 When load is applied at 1/3 length from output shaft edge.

## Characteristics diagram

Momentary allowable torque --- Source current (no load) --- fs: Maximum self-start frequency when not loaded  
Allowable torque — Source current (load applied) ·····

### FD521S-HX50 FD521D-HX50

Winding current:  
0.75 A/phase

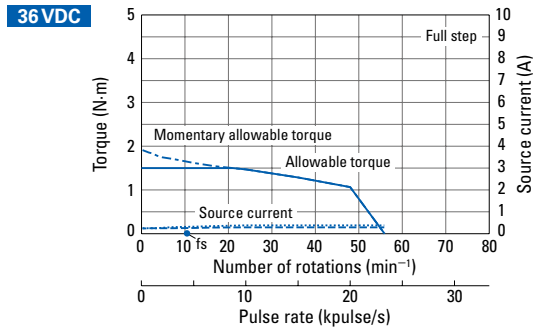
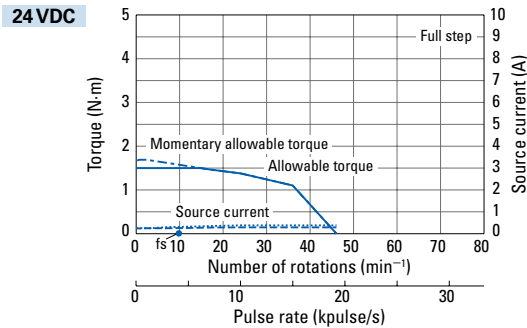

### FD521S-HX100 FD521D-HX100

Winding current:  
0.75 A/phase

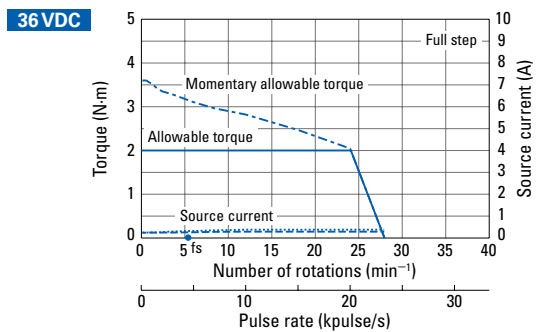
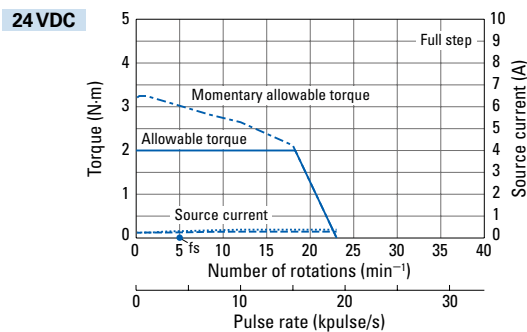

### FD541S-HX30 FD541D-HX30

Winding current:  
1.4 A/phase

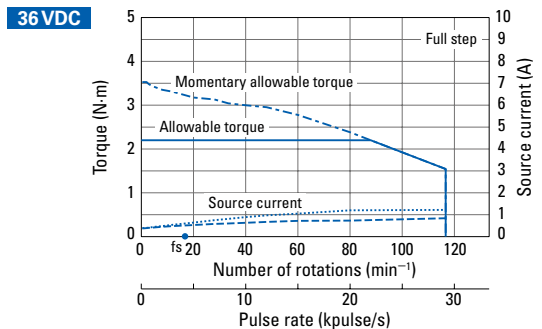
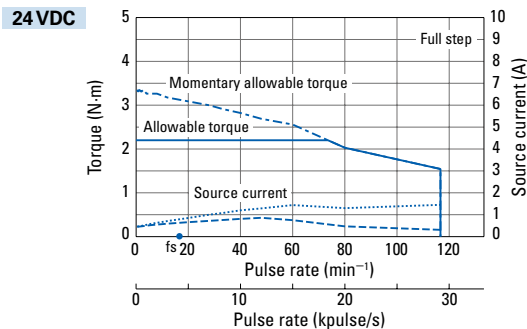

### FD541S-HX50 FD541D-HX50

Winding current:  
1.4 A/phase

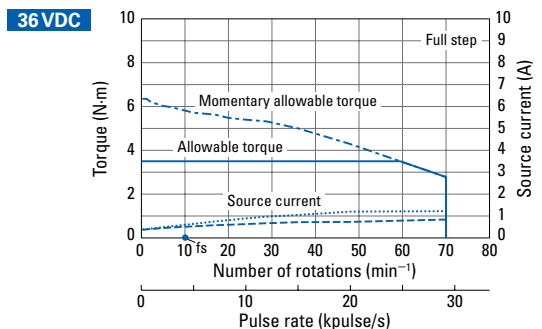
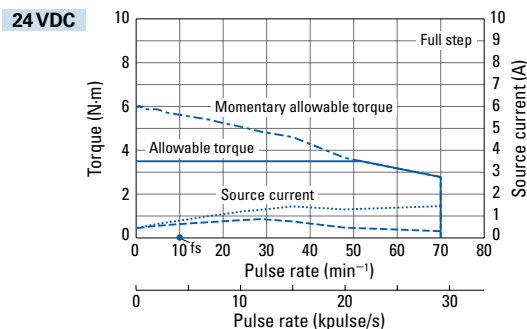

System Configuration Diagram ▶ p. 82 Set Model Configuration ▶ p. 84 Motor Dimensions ▶ pp. 71 to 74 Driver Dimensions ▶ p. 100

If allowable instantaneous torque is exceeded when using a motor with harmonic gears, the gears may be damaged. When selecting a motor, ensure that its allowable instantaneous torque will not be exceeded. Data is measured under the trial conditions of SANYO DENKI. Driving torque may vary according to actual machine precision.

## Harmonic gear model

DC input Driver (Model number: FS1D140P10) + Motor with harmonic gear

RoHS

Rated current: 28 mm sq. Motor 0.75 A/phase, 42 mm sq. to 86 mm sq. Motor 1.4 A/phase

Motor size	42 mm sq.	60 mm sq.		86 mm sq. (angular dimension 90 mm sq.)
Motor + gear length	74.4 mm	116.3 mm		148 mm
Single shaft	<b>Set model number</b> FDF541S-HX100 Configuration item: motor model number SF5421-82HXM41	<b>FDM561S-HX50</b> SM5601-82HXL41	<b>FDM561S-HX100</b> SM5601-82HXM41	<b>FDM581S-HX50</b> SM5861-82HXL41
Dual shaft	<b>Set model number</b> FDF541D-HX100 Configuration item: motor model number SF5421-82HXM11	<b>FDM561D-HX50</b> SM5601-82HXL11	<b>FDM561D-HX100</b> SM5601-82HXM11	<b>FDM581D-HX50</b> SM5861-82HXL11
Allowable torque	N·m	5	5.5	8
Momentary allowable torque	N·m	11	14	20
Rotor inertia	$\times 10^{-4}$ kg·m <sup>2</sup>	0.04	0.23	0.23
Rated current	A/phase	1.4	1.4	1.4
Basic step angle	°	0.0072	0.0144	0.0072
Gear ratio	—	1:100	1:50	1:100
Hysteresis loss	Arc min or less	2.4	-	-
Lost motion	Arc min	-	0.4 to 3 ( $\pm 0.28$ N·m)	0.4 to 1.5 ( $\pm 0.4$ N·m)
Allowable speed	min <sup>-1</sup>	35	70	35
Motor mass *1	kg	0.44	1.22	1.22
Allowable thrust load	N	1150	400	400
Allowable radial load *2	N	275	360	360

Note: The motor and gear output shaft rotate in the opposite direction.

\*1 Driver mass ▶ p. 100 \*2 When load is applied at 1/3 length from output shaft edge.

## Characteristics diagram

Winding current: 1.4A/phase

Momentary allowable torque ——— Source current (no load) ——— fs: Maximum self-start frequency when not loaded ●  
Allowable torque ——— Source current (load applied) ······

**FDF541S-HX100**  
**FDF541D-HX100**

**24 VDC**

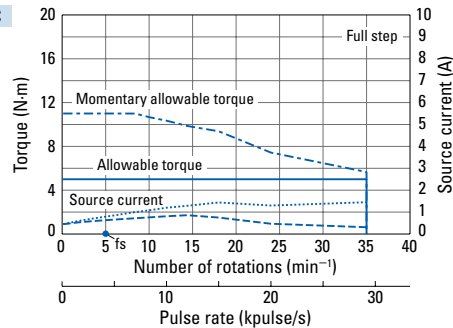

**36 VDC**

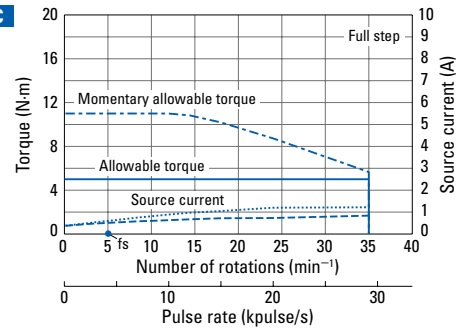

**FDM561S-HX50**  
**FDM561D-HX50**

**24 VDC**

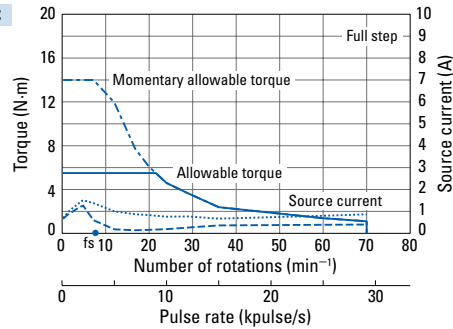

**36 VDC**

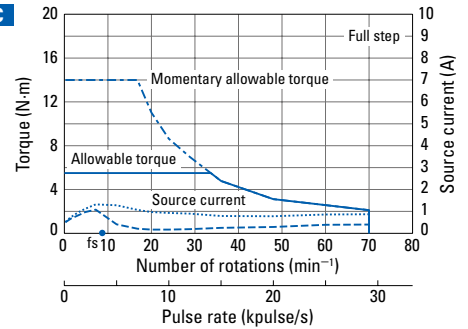

**FDM561S-HX100**  
**FDM561D-HX100**

**24 VDC**

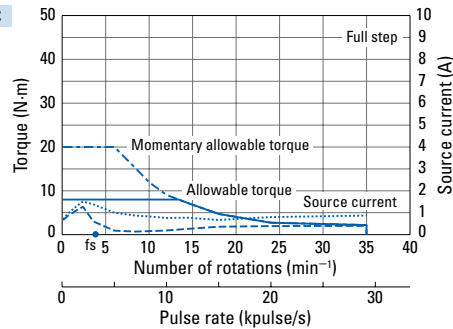

**36 VDC**

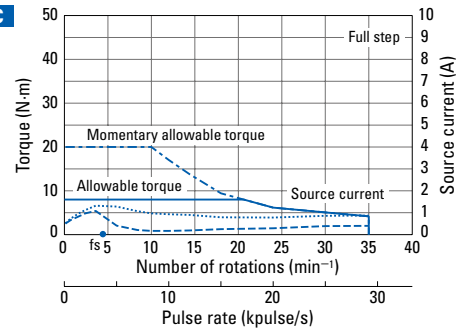

**FDM581S-HX50**  
**FDM581D-HX50**

**24 VDC**

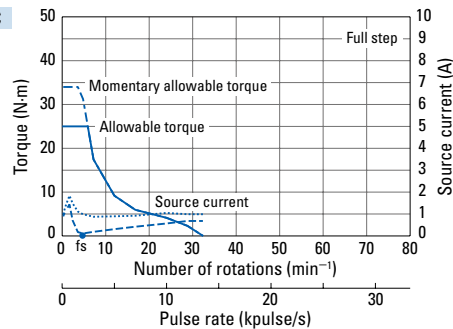

**36 VDC**

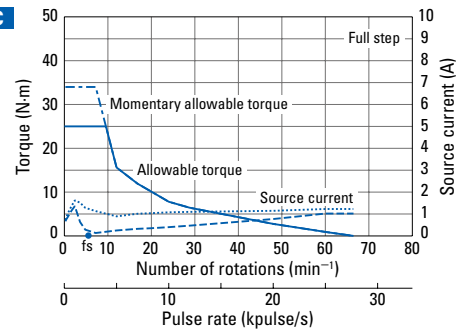



# Harmonic gear model

DC input Driver (Model number: FS1D140P10) + Motor with harmonic gear

RoHS

Rated current: 28 mm sq. Motor 0.75 A/phase, 42 mm sq. to 86 mm sq. Motor 1.4 A/phase

Motor size	86 mm sq. (angular dimension 90 mm sq.)	
Motor + gear length	148 mm	
Single shaft	Set model number	FDM581S-HX100
	Configuration item: motor model number	SM5861-82HXM41
Dual shaft	Set model number	FDM581D-HX100
	Configuration item: motor model number	SM5861-82HXM11
Allowable torque	N·m	40
Momentary allowable torque	N·m	59
Rotor inertia	$\times 10^{-4} \text{kg}\cdot\text{m}^2$	1.68
Rated current	A/phase	1.4
Basic step angle	$^{\circ}$	0.0072
Gear ratio	—	1:100
Hysteresis loss	Arc min or less	-
Lost motion	Arc min	0.4 to 3 ( $\pm 1.2 \text{ N}\cdot\text{m}$ )
Allowable speed	$\text{min}^{-1}$	35
Motor mass *1	kg	3.6
Allowable thrust load	N	1400
Allowable radial load *2	N	1600

Note: The motor and gear output shaft rotate in the opposite direction.

\*1 Driver mass ▶ p. 100 \*2 When load is applied at 1/3 length from output shaft edge.

## Characteristics diagram

Winding current: 1.4A/phase

Momentary allowable torque ————  
Allowable torque ————

Source current (no load) ————  
Source current (load applied) ······

fs: Maximum self-start frequency when not loaded ●

**FDM581S-HX100**  
**FDM581D-HX100**

**24 VDC**

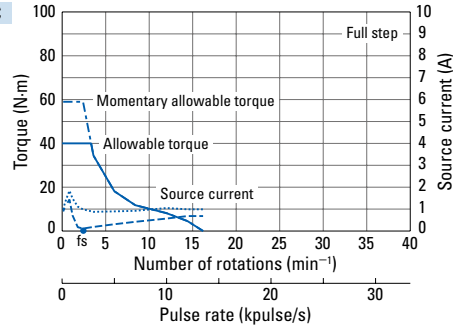

**36 VDC**

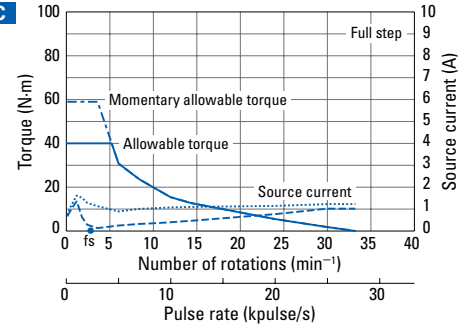

# Electromagnetic brake model

DC input Driver (Model number: FS1D140P10) + Motor with electromagnetic brake

RoHS

Basic step angle: 0.72° Rated current: 1.4 A/phase

Motor size		42 mm sq.			60 mm sq.	
Motor + brake length		68 mm	74.3 mm	82 mm	91.4 mm	
Single shaft	Set model number	FD541S-XB	FD542S-XB	FD543S-XB	FD561S-XB	
Configuration item: motor model number		SF5421-82XB41	SF5422-82XB41	SF5423-82XB41	SM5601-82XB41	
Holding torque	N·m min.	0.125	0.185	0.245	0.57	
Rotor inertia	×10 <sup>-4</sup> kg·m <sup>2</sup>	0.043	0.06	0.071	0.36	
Rated current	A/phase	1.4	1.4	1.4	1.4	
Motor mass *1	kg	0.39	0.46	0.53	0.96	
Allowable thrust load	N	10	10	10	20	
Allowable radial load *2	N	56	54	52	191	
Electromagnetic brake	Brake type	No excitation actuating type			No excitation actuating type	
	Power supply input	24±5%			24±5%	
	Power consumption	2.4 (75°C)			6 (75°C)	
	Static friction torque	N·m min.	0.3	0.3	0.3	0.8
	Brake operating time	ms max.	20	20	20	20
	Brake release time	ms max.	30	30	30	30

\*1 Driver mass ▶ p. 100

\*2 The load point is at the tip of the output shaft.

## Characteristics diagram

Winding current: 1.4A/phase  
With rubber coupling

Pull-out torque ——— Source current (no load) - - - - -  
fs: Maximum self-start frequency when not loaded ●

Source current (load applied) ······

### FD541S-XB

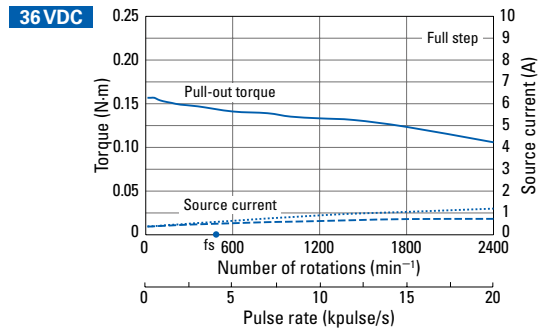
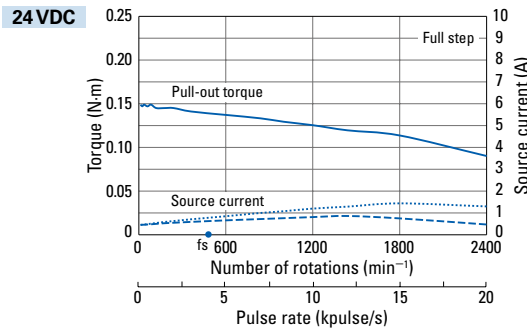

### FD542S-XB

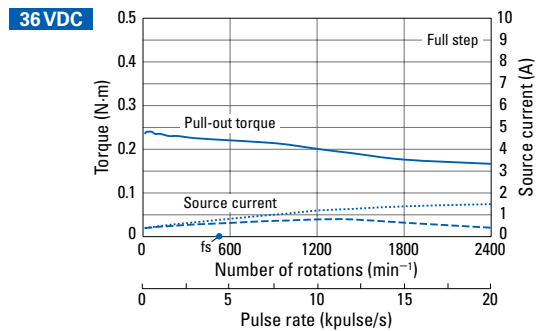
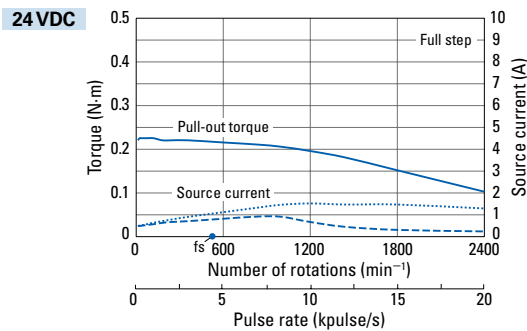

### FD543S-XB

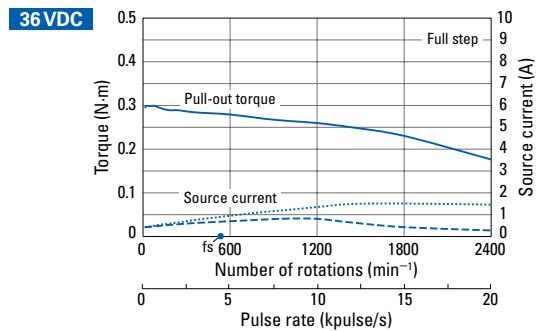
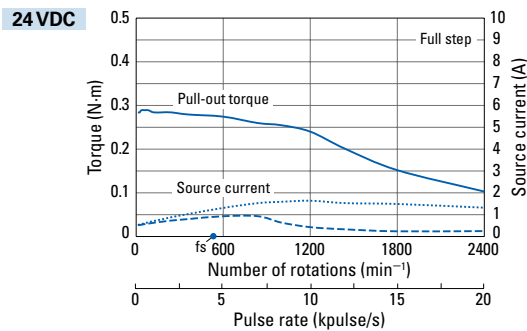

### FD561S-XB

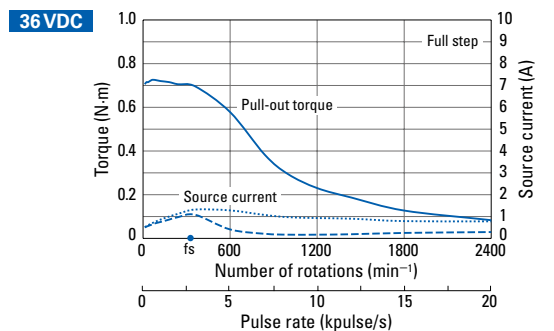
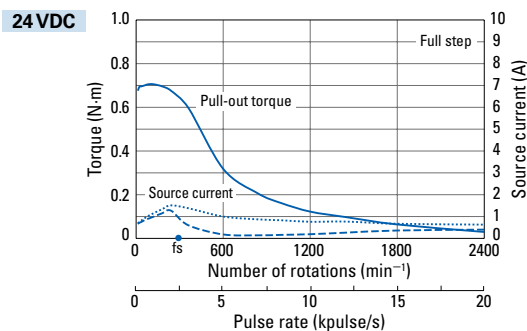

# Electromagnetic brake model

DC input Driver (Model number: FS1D140P10) + Motor with electromagnetic brake

RoHS

Basic step angle: 0.72° Rated current: 1.4 A/phase

Motor size			60 mm sq.		86 mm sq.	
Motor + brake length			102.6 mm	131.3 mm	119.5 mm	150 mm
Single shaft	Set model number		FDM562S-XB	FDM563S-XB	FDM581S-XB	FDM582S-XB
	Configuration item: motor model number		SM5602-82XB41	SM5603-82XB41	SM5861-82XB41	SM5862-82XB41
Holding torque	N·m min.		0.9	1.7	2.3	4.4
Rotor inertia	$\times 10^{-4}$ kg·m <sup>2</sup>		0.47	0.76	2.55	4.07
Rated current	A/phase		1.4	1.4	1.4	1.4
Motor mass *1	kg		1.14	1.61	2.6	3.75
Allowable thrust load	N		20	20	60	60
Allowable radial load *2	N		183	170	200	200
Electromagnetic brake	Brake type		No excitation actuating type		No excitation actuating type	
	Power supply input		24±5%		24±10%	
	Power consumption		6 (75°C)		10.5 (20°C)	
	Static friction torque		0.8		5	
	Brake operating time		20		20	
Brake release time		30		50		

\*1 Driver mass ▶ p. 100

\*2 The load point is at the tip of the output shaft.

## Characteristics diagram

Winding current: 1.4A/phase  
With rubber coupling

Pull-out torque ———

Source current (no load) - - - - -

Source current (load applied) ······

fs: Maximum self-start frequency when not loaded ●

### FDM562S-XB

24 VDC

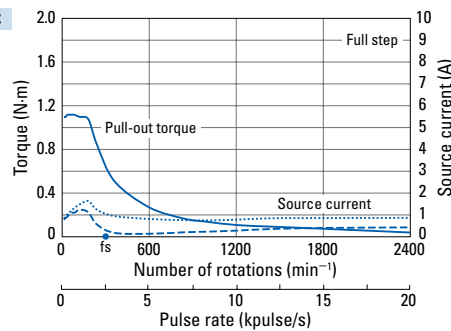

36 VDC

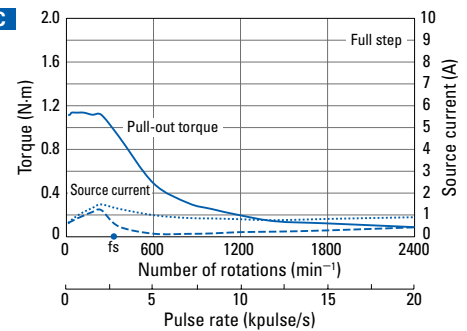

### FDM563S-XB

24 VDC

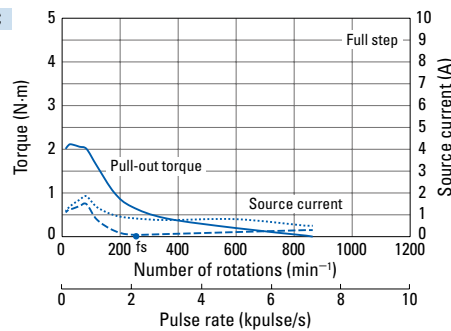

36 VDC

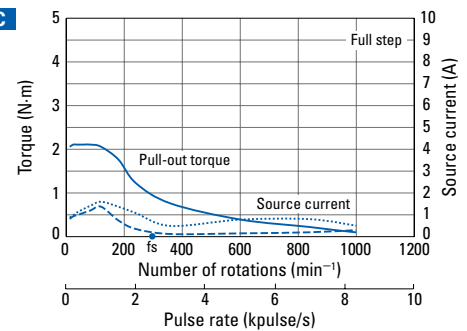

### FDM581S-XB

24 VDC

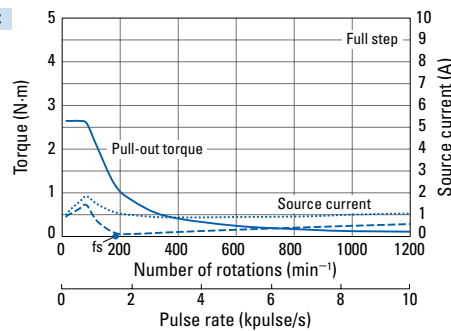

36 VDC

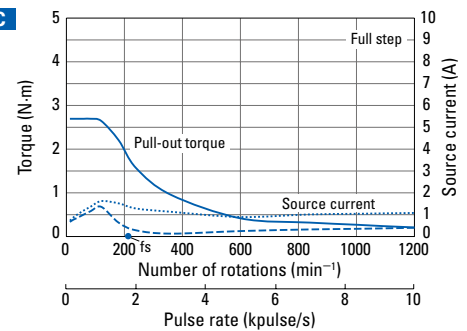

### FDM582S-XB

24 VDC

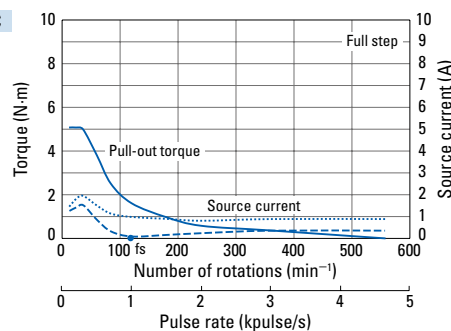

36 VDC

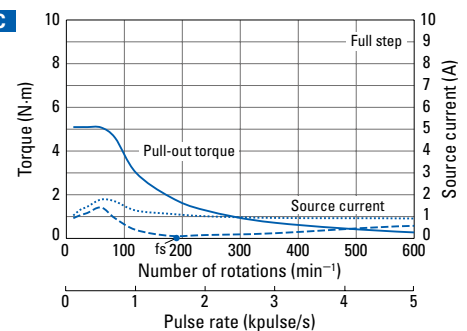

# Stepping Motor Dimensions, General Specifications, Internal Wiring, and Rotation Directions

Same as DC set model (microstep). See pages 71–75.

## Driver Dimensions (Unit: mm)

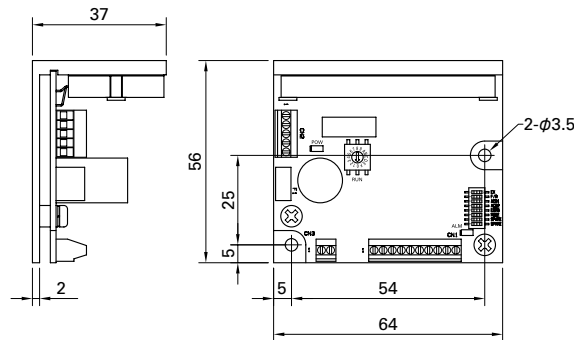

## Driver Specifications

### General specifications

Basic specifications	Model number	FS1D140P10	
	Power supply	24 VDC/36 VDC±10%	
	Source current	3 A	
	Environment	Protection class	Class III
		Operation environment	Installation category (over-voltage category): I (CE) Pollution level: 2
		Operating ambient temperature	0 to +50°C
		Storage temperature	-20 to +70°C
		Operating ambient humidity	35 to 85% RH (no condensation)
		Storage humidity	10 to 90% RH (no condensation)
		Operation altitude	1000 m or less above sea level
		Vibration resistance	Tested under the following conditions; 5 m/s <sup>2</sup> , frequency range 10 to 55 Hz, direction along X, Y and Z axes, for 2 hours each
	Impact resistance	Not influenced at NDS-C-0110 standard section 3.2.2 division "C".	
	Withstandable voltage	Not influenced when 500 VAC is applied between power input terminal and cabinet for one minute.	
Insulation resistance	10 MΩ min. when measured with 500 VDC megohmmeter between input terminal and cabinet.		
Mass	0.1 kg		
Functions	Selection function	Basic step angle, pulse input type, original excitation phase, stopping current, operating current	
	Protection functions	Open phase protection, Voltage reduction in the main circuit power	
	LED indication	Power supply monitor, Alarm display (motor cable fault, switching element fault, main circuit voltage out of specified range)	
I/O signals	Command pulse input signal	Photocoupler input system; input resistance: 220 Ω Input-signal "H" level: 4.0 to 5.5 V; input-signal "L" level: 0 to 0.5 V MAX. input frequency: 35 kpulse/s	
	Power down input signal	Photocoupler input system; input resistance: 220 Ω Input-signal "H" level: 4.0 to 5.5 V; input-signal "L" level: 0 to 0.5 V	
	Phase origin monitor output signal	Open collector output by Photocoupler, output signal standard, V <sub>ceo</sub> = 40 V max., I <sub>c</sub> = 10 mA max.	
	Alarm output signal	Open collector output by Photocoupler, output signal standard, V <sub>ceo</sub> = 40 V max., I <sub>c</sub> = 10 mA max.	

### Safety standards

	Directives	Category	Standard	Name
CE (TÜV)	Low-voltage directives	—	EN61010-1	—
	EMC directives	Emission	EN55011-A	Terminal disturbance voltage
			EN55011-A	Electromagnetic radiation disturbance
			EN61000-4-2	ESD (Electrostatic discharge)
		Immunity	EN61000-4-3	RS (Radio-frequency amplitude modulated electromagnetic field)
			EN61000-4-4	Fast transients
			EN61000-4-6	Surges
UL	Acquired standards	Applicable standard	File No.	
	UL	UL508C	E179775	
	UL for Canada (c-UL)			

- EMC characteristics may vary depending on the configuration of the users' control panel, which contains the driver or stepping motor, or the arrangement and wiring of other electrical devices. Parts for EMC noise suppression like noise filters and toroidal type ferrite cores may be required depending on circumstances.
- Validation test of driver has been performed for low-voltage EMC directives at TÜV (TÜV product service) for self-declaration of CE marking.

# Driver Controls and Connectors

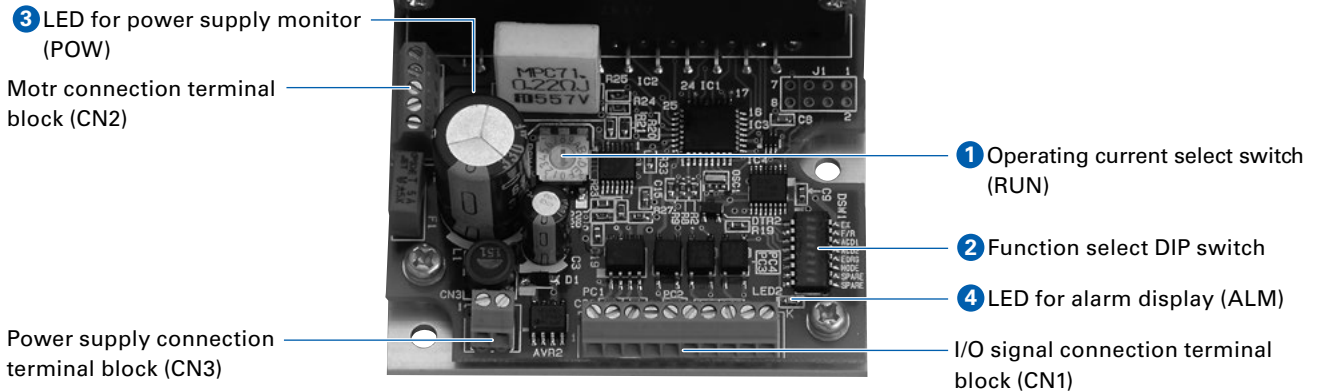

## 1 Operating current select switch (RUN)

Motor operation current value can be set with the rotary switch.

Indication	0	1	2	3	4	5	6	7
Stepping motor current (A)	1.4	1.35	1.3	1.25	1.2	1.15	1.1	1.05
Indication	8	9	A	B	C	D	E	F
Stepping motor current (A)	1.0	0.95	0.9	0.85	0.8	0.75	0.7	0.65

The factory default value is F (0.65A). Select the current after checking the rated current of the combination motor.

## 2 Function select DIP switch

Select the function depending on your specification.

Factory default settings

	OFF	ON	
EX	<input type="checkbox"/>	<input type="checkbox"/>	Half step
F/R	<input type="checkbox"/>	<input type="checkbox"/>	2-input type (CW/CCW pulse input)
ACD1	<input type="checkbox"/>	<input type="checkbox"/>	Stopping current: 40% of operating current
ACD2	<input type="checkbox"/>	<input type="checkbox"/>	
EORG	<input type="checkbox"/>	<input type="checkbox"/>	Phase origin
MODE	<input type="checkbox"/>	<input type="checkbox"/>	Reservation: Don't turn it ON.
SPARE	<input type="checkbox"/>	<input type="checkbox"/>	
SPARE	<input type="checkbox"/>	<input type="checkbox"/>	

## Step angle selection (EX)

Select the basic step angle.

EX	Exciting mode
ON	Full step (0.72°/pulse)
OFF	Half step (0.36°/pulse)

## Input type selection (F/R)

Select the input pulse type.

F/R	Input pulse type
ON	1-input type (CK, U/D)
OFF	2-input type (CW, CCW)

## Current select when stopping (ACD1, ACD2)

Select the current value of the motor when stopping.

ACD2	ACD1	Motor current
ON	ON	100% of operating current
ON	OFF	60% of operating current
OFF	ON	50% of operating current
OFF	OFF	40% of operating current

Initial configuration of factory shipment is set to 40% of rated value.

Driver and motor should be operated at around 50% of rated value to reduce heat.

## Excitation selection (EORG)

The excitation phase when the power supply is engaged is selected.

EORG	Original excitation phase
ON	Excitation phase at power shut off
OFF	Phase origin

By turning on the EORG, the excitation phase during power OFF will be saved. Therefore, there will be no shaft displacement when turning the power ON.

## 3 LED for power supply monitor (POW)

Lights up when main circuit power supply is switched on.

Indication	Indication Explanation
"POW" is displayed.	Main circuit power supply is switched on.

## 4 LED for alarm display (ALM)

Lights up during alarm conditions.

Indication	Explanation
"ALM" is displayed.	Motor cable is broken, or switching element in driver is faulty. The main circuit voltage is out of specifications range (Less than 19 VDC).

When "ALM" is displayed, the winding current of the stepping motor is cut off and it is in a "non-excitation" state. At the same time, an output signal (photocoupler ON) is transmitted from the alarm output terminal (AL) to an external source. When the alarm circuit is operating, this state is maintained until it is reset by switching on the power supply again. When an alarm condition has occurred, please take corrective actions to rectify the cause of the alarm before switching on the power supply again.

# Connections and Signals

## External wiring diagram

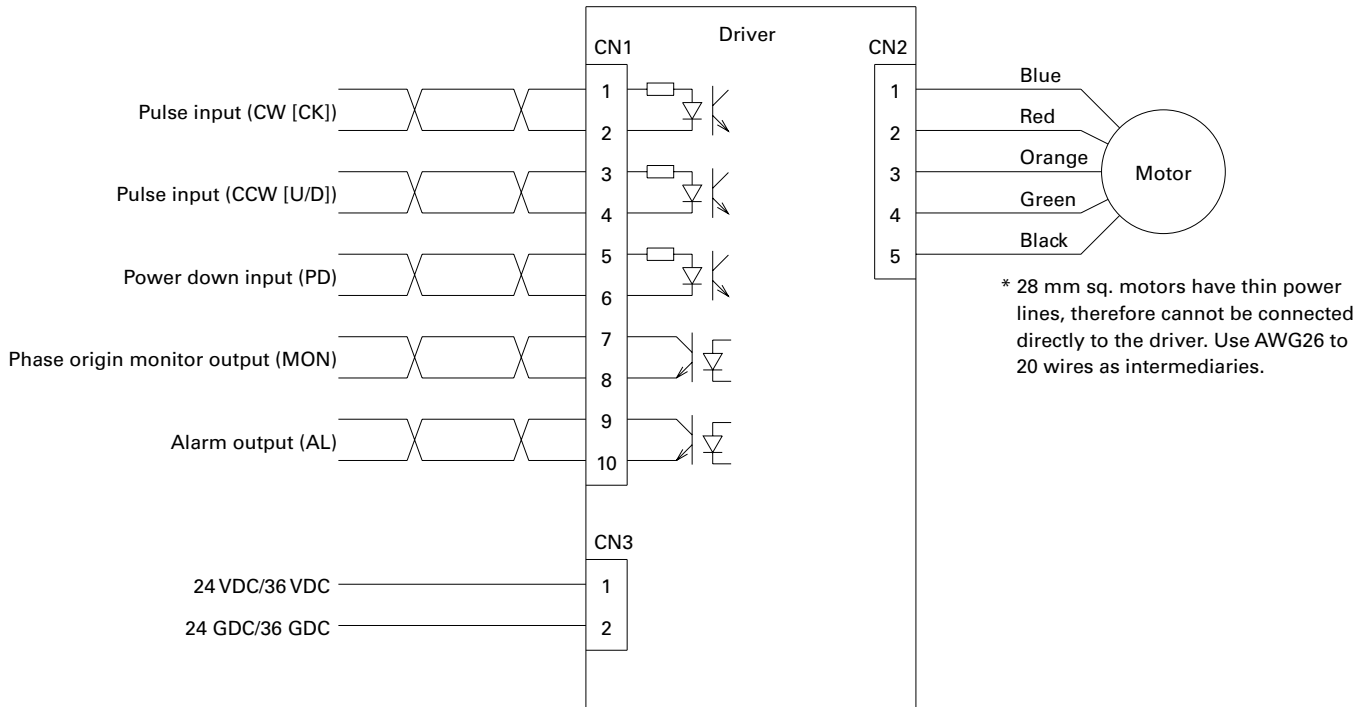

## Applicable wire sizes

Part	Wire sizes	Allowable wire length
For power	AWG22 (0.3 mm <sup>2</sup> )	2 m max.
For input/output signal	AWG24 (0.2 mm <sup>2</sup> ) to AWG22 (0.3 mm <sup>2</sup> )	2 m max.
For motor	AWG26 (0.12 mm <sup>2</sup> ) to AWG20 (0.5 mm <sup>2</sup> )	Under 3 m

When bundling wire together or running wires through duct, take reduction rate of each wire allowable current into consideration.  
 When ambient temperature is relatively high, wire product lifetime is reduced due to heat deterioration.  
 When extending the motor line, use as thick a wire as possible.

## Specification summary of input/output signals

Signal name	CN1 Pin number	Function summary
CW pulse input (standard)	1 2	When in "2-input type", input the drive pulse that rotates in a CW direction.
Pulse train input	1 2	When in "1-input type", input the drive pulse train for motor rotation.
CCW pulse input (standard)	3 4	When in "2-input type", input the drive pulse train that rotates in a CCW direction.
Rotational direction input	3 4	When in "1-input type", input the motor rotational direction signal. Internal photocoupler ON ... CW direction Internal photocoupler OFF ... CCW direction
Power down input	5 6	Inputting the PD signal cuts OFF the current flowing through the stepping motor. internal photocoupler ON ... PD function enabled internal photocoupler OFF ... PD function disabled
Phase origin monitor output	7 8	It is turned ON when the excitation phase is at the origin (in the state when the power is turned ON) It is turned ON once per 10 pulses when setting to full step. It is turned ON once per 20 pulses when setting to half step.
Alarm output	9 10	The signal is externally output (photocoupler ON) when one of several alarm circuits operates in the PM driver. At this time, the stepping motor is in the unexcited state.

As for the motor rotational direction, CW direction is regarded as the clockwise rotation, and CCW direction is regarded as the counterclockwise rotation by viewing the motor from output shaft side.

# Input Circuit Configuration of CW (CK), CCW (U/D)

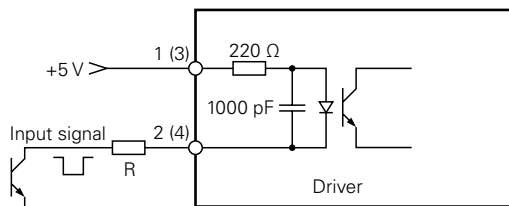

- Pulse duty 50% max.
- Maximum input frequency: 35 kpulse/s
- If the peak voltage of the input signal exceeds 5.5 V, please add an external current-limiting resistor R to limit the input current to around 15 mA. (Take the photocoupler forward voltage of 1.5 V into consideration.)

## Timing of command pulse

### 2-input type (CW, CCW)

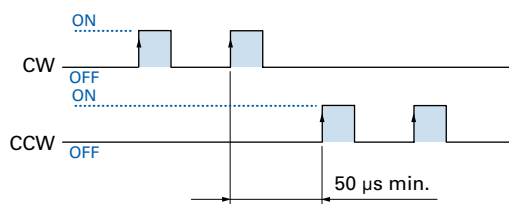

- The shaded areas in the diagram on the left indicate the internal photocoupler is ON. Internal circuit (motor) starts operating at the leading edge of photocoupler ON.
- To apply pulse to CW, set CCW side internal photocoupler to OFF.
- To apply pulse to CCW, set CW side internal photocoupler to OFF.

### 1-input type (CK, U/D)

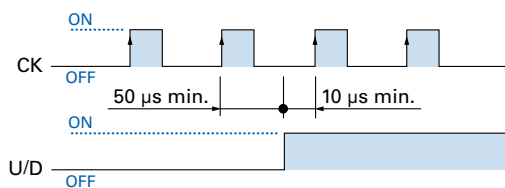

- The shaded areas in the diagram on the left indicate the internal photocoupler is ON. Internal circuit (motor) starts operating at the leading edge of CK side photocoupler ON.
- Switching of U/D input signal must be done while CK side internal photocoupler is OFF.

## Input signal specification

(Photocoupler type)

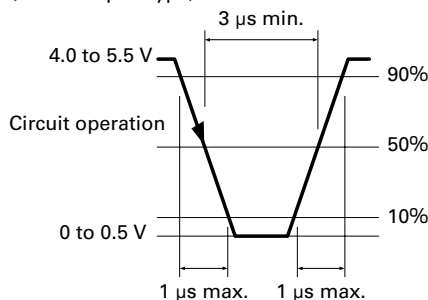

# Input Circuit Configuration of PD

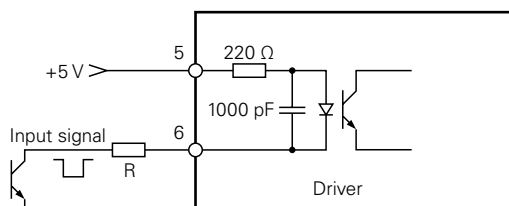

- If the peak voltage of the input signal exceeds 5.5 V, please add an external current-limiting resistor R to limit the input current to around 15 mA. (Take the photocoupler forward voltage of 1.5 V into consideration.)

# Output Signal Configuration of MON, AL

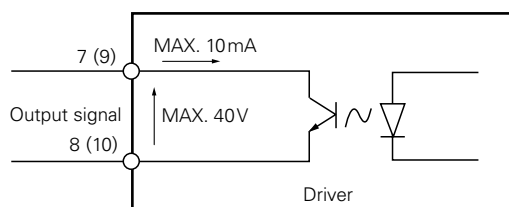

## MON output

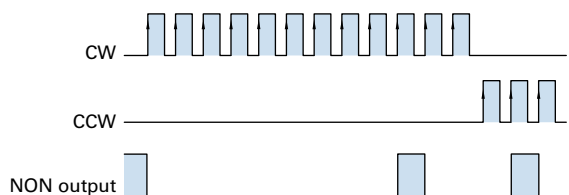

- When the motor excitation phase is at the phase origin (power ON status), the photocoupler is ON.
- MON output is taken at every 7.2 degrees of motor output shaft from phase origin.

Example: 1 division (Full step)





# Stepping Motors

Stepping Motors

▶ p. 108–

Linear Actuator Stepping Motors

▶ p. 115–

Stepping Motors for Vacuum Environments





Customized Products

▶ p. 117

# Lineup

## Stepping Motors RoHS

These motors can be purchased as separate units.

Basic step angle	Motor size	Holding torque Model number	Customizing*	Page
0.72°	28 mm sq. 	0.041 to 0.078 SH528□-72□1	Hollow Shaft modification Decelerator Encoder	p. 108
0.72°	42 mm sq. (CE/UL Model) 	0.13 to 0.245 SM542□-□2□1	Hollow Shaft modification Decelerator Encoder Brake	p. 109
0.72°	50 mm sq. 	0.225 to 0.37 103H650□-73□1	Hollow Shaft modification Encoder	p. 110
0.72°	60 mm sq. (CE/UL Model) 	0.57 to 1.7 SM560□-□2□1	Hollow Shaft modification Decelerator Encoder Brake	p. 111
0.72°	86 mm sq. (CE/UL Model) 	2.3 to 6.8 SM586□-□2□1	Hollow Shaft modification Decelerator Encoder Brake	p. 112

\*Specifications can be customized, depending on the model number and quantity. Contact us for details.

## Linear Actuator Stepping Motors RoHS

Motor size	Thrust Model number	Page
42 mm sq. 	370N SL5421-72□□	p. 115
60 mm sq. 	450N SL5601-82□□	p. 115

## Stepping Motors for Vacuum Environments Customized Products

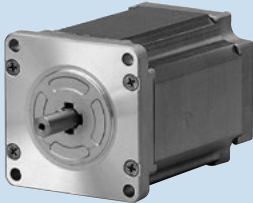
Motor size	Page
42 mm sq. to 86 mm sq. 	p. 117

# Customization

Different types of customization are possible, depending on the request and quantity. Contact us for details.

## Manufacturing example

### Harness modification

Connectors, cable ties, and plastic tubing can be added.

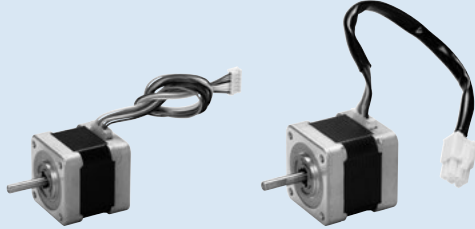

### Decelerator, encoder, brake

- A decelerator can be added when a large high-load torque is required at low speeds.
- An encoder can be added in order to detect position and speed.
- A brake can be added to hold the position when the motor is stopped.

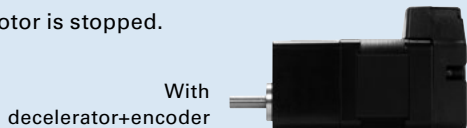

### Shaft modification

D-cuts, key grooves, and through holes can be added; and gears and pulleys can be mounted. The shaft can also be hollowed to allow air flow or to pass lead wires through.

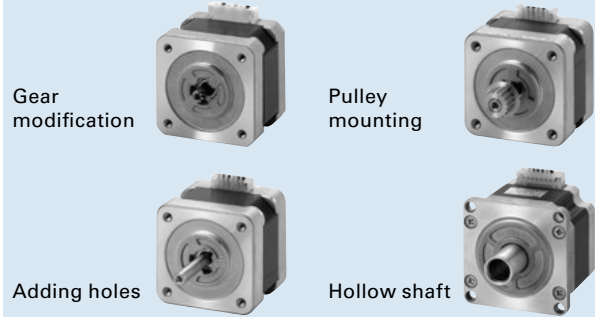

### Rotating damper, mounting-side damper

A damper can be added to reduce vibrations when rotating.



# How To Read the Specifications

① Model number	② Holding torque at 4-phase energization		③ Rated current	④ Wiring resistance	⑤ Winding inductance	⑥ Rotor inertia	⑦ Mass (Weight)	Motor length (L)
	Single shaft	Dual shaft	N·m min.	A/phase	Ω/phase	mH/phase	×10 <sup>-4</sup> kg·m <sup>2</sup>	kg
SH5281-7241	SH5281-7211	0.041	0.75	1.05	0.44	0.01	0.11	32
SH5285-7241	SH5285-7211	0.078	0.75	1.15	0.64	0.022	0.2	51.5

## Characteristics diagram

### SH5281-7241 SH5281-7211

Constant current circuit  
Source voltage: 24 VDC  
Operating current:  
0.75 A/phase, 4-phase,  
energization (full step)  
 $J_L=0.01 \times 10^{-4} \text{kg} \cdot \text{m}^2$   
(pulley balancer method)  
 $f_s$ : Maximum self-start  
frequency when not  
loaded

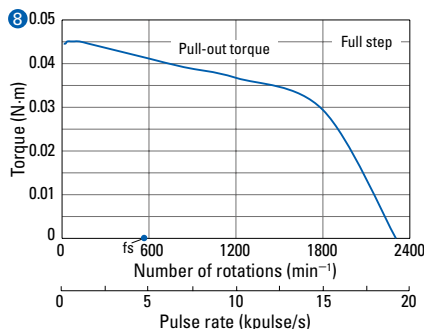

### SH5285-7241 SH5285-7211

Constant current circuit  
Source voltage: 24 VDC  
Operating current:  
0.75 A/phase, 4-phase,  
energization (full step)  
 $J_L=0.01 \times 10^{-4} \text{kg} \cdot \text{m}^2$   
(pulley balancer method)  
 $f_s$ : Maximum self-start  
frequency when not  
loaded

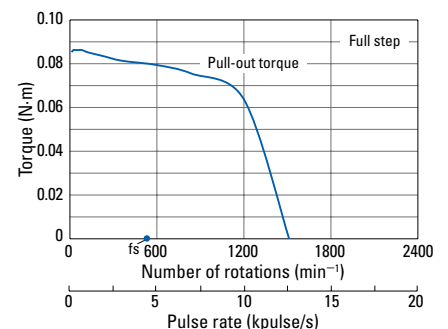

- ① This is the stepping motor model number.
- ② This is the maximum torque that occurs with 4-phase excitation of the stepping motor at rated current, causing the shaft to rotate from the outside.
- ③ This is the rated current that flows to the motor winding. Allowing this amount of current to flow to the motor will create torque equal to the holding torque value.
- ④ This is the resistance for one phase of the stepping motor winding.

- ⑤ This is the inductance for one phase of the stepping motor winding.
- ⑥ This is the moment of inertia of the rotor, which shows how much torque is required to cause the rotor to accelerate or decelerate.
- ⑦ This is the mass (weight) of the stepping motor.
- ⑧ This graph shows the relationship between the full step pulse rate (frequency), speed, and pull-out torque.

# Stepping Motors

Allowable Load, Internal Wiring, Rotation Direction ▶ p. 113  
 General Specifications ▶ p. 114



## 28 mm sq.

0.72°/step **RoHS**  
 Lead wire type  
 New pentagon connection

### Customizing

- Hollow Shaft modification
- Decelerator Encoder

Varies depending on the model number and quantity. Contact us for details.

Model number		Holding torque at 4-phase energization	Rated current	Wiring resistance	Winding inductance	Rotor inertia	Mass (Weight)	Motor length (L)
Single shaft	Dual shaft	N·m min.	A/phase	Ω/phase	mH/phase	×10 <sup>-4</sup> kg·m <sup>2</sup>	kg	mm
<b>SH5281-7241</b>	<b>SH5281-7211</b>	0.041	0.75	1.05	0.44	0.01	0.11	32
<b>SH5285-7241</b>	<b>SH5285-7211</b>	0.078	0.75	1.15	0.64	0.022	0.2	51.5

### Characteristics diagram

#### SH5281-7241 SH5281-7211

Constant current circuit  
 Source voltage: 24 VDC  
 Operating current:  
 0.75 A/phase, 4-phase,  
 energization (full step)  
 $J_L=0.01 \times 10^{-4} \text{kg} \cdot \text{m}^2$   
 (pulley balancer method)  
 fs: Maximum self-start  
 frequency when not  
 loaded

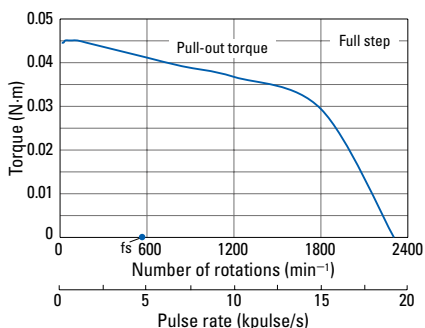

#### SH5285-7241 SH5285-7211

Constant current circuit  
 Source voltage: 24 VDC  
 Operating current:  
 0.75 A/phase, 4-phase,  
 energization (full step)  
 $J_L=0.01 \times 10^{-4} \text{kg} \cdot \text{m}^2$   
 (pulley balancer method)  
 fs: Maximum self-start  
 frequency when not  
 loaded

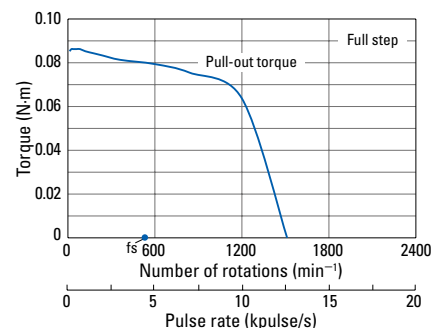

### Dimensions [Unit: mm]

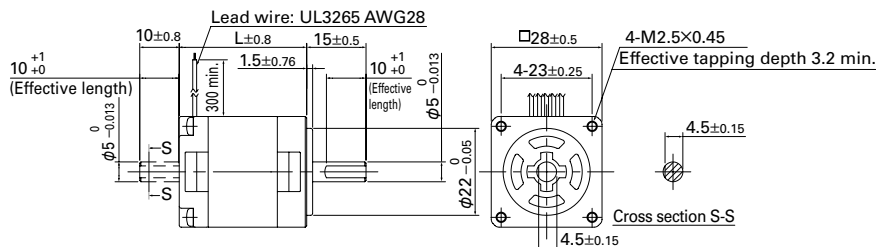

### Internal wiring

Connection method: New pentagon connection

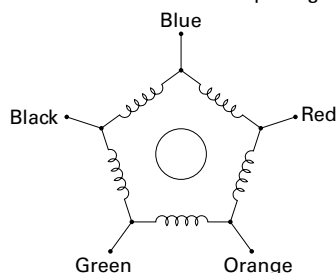

### Compatible drivers

Model number: F5PAE140P100, FS1D140P10 (DC input)  
 Operating current select switch setting: D



# 42 mm sq.

0.72°/step **RoHS** **CE** **UL**

Lead wire type  
New pentagon connection

### Customizing

Hollow Shaft modification  
Decelerator Encoder Brake

Varies depending on the model number and quantity. Contact us for details.

Model number		Holding torque at 4-phase energization	Rated current	Wiring resistance	Winding inductance	Rotor inertia	Mass (Weight)	Motor length (L)
Single shaft	Dual shaft	N·m min.	A/phase	Ω/phase	mH/phase	×10 <sup>-4</sup> kg·m <sup>2</sup>	kg	mm
<b>SM5421-3241</b>	<b>SM5421-3211</b>	0.13	0.35	4.7	5.8	0.028	0.24	35
<b>SM5422-3241</b>	<b>SM5422-3211</b>	0.185	0.35	5.8	10	0.045	0.31	41
<b>SM5423-3241</b>	<b>SM5423-3211</b>	0.245	0.35	7.2	11	0.056	0.38	49
<b>SM5421-7241</b>	<b>SM5421-7211</b>	0.13	0.75	1.1	1.3	0.028	0.24	35
<b>SM5422-7241</b>	<b>SM5422-7211</b>	0.185	0.75	1.3	2.3	0.045	0.31	41
<b>SM5423-7241</b>	<b>SM5423-7211</b>	0.245	0.75	1.6	2.5	0.056	0.38	49

## Characteristics diagram

### SM5421-3241 SM5421-3211

Constant current circuit  
Source voltage: 100 VAC  
Operating current:  
0.35 A/phase, 4-phase  
energization (full step)  
 $J_L=0.33 \times 10^{-4} \text{kg} \cdot \text{m}^2$   
(use the rubber coupling)

Compatible drivers:  
F5PAA035P100 (AC input)  
Operating current select  
switch setting: 0

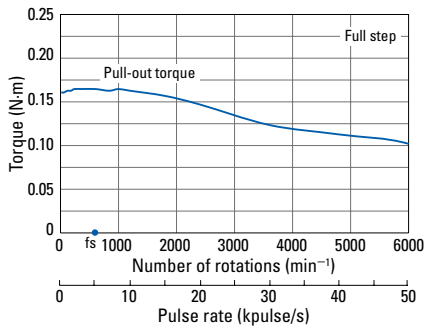

### SM5422-3241 SM5422-3211

Constant current circuit  
Source voltage: 100 VAC  
Operating current:  
0.35 A/phase, 4-phase  
energization (full step)  
 $J_L=0.94 \times 10^{-4} \text{kg} \cdot \text{m}^2$   
(use the rubber coupling)

Compatible drivers:  
F5PAA035P100 (AC input)  
Operating current select  
switch setting: 0

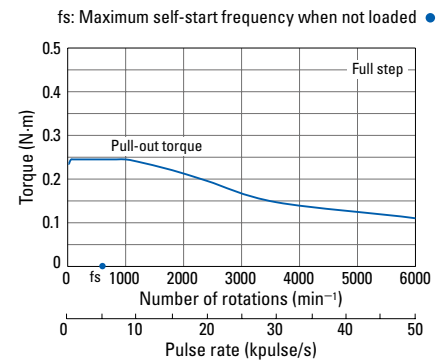

### SM5423-3241 SM5423-3211

Constant current circuit  
Source voltage: 100 VAC  
Operating current:  
0.35 A/phase, 4-phase  
energization (full step)  
 $J_L=0.94 \times 10^{-4} \text{kg} \cdot \text{m}^2$   
(use the rubber coupling)

Compatible drivers:  
F5PAA035P100 (AC input)  
Operating current select  
switch setting: 0

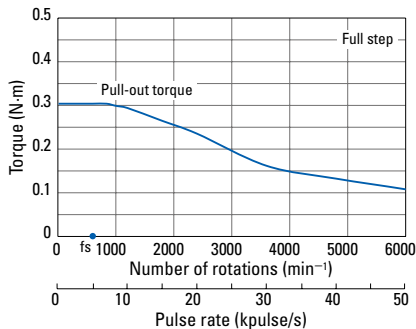

### SM5421-7241 SM5421-7211

Constant current circuit  
Source voltage: 24 VDC  
Operating current:  
0.75 A/phase, 4-phase  
energization (full step)  
 $J_L=0.33 \times 10^{-4} \text{kg} \cdot \text{m}^2$   
(use the rubber coupling)

Compatible drivers:  
FS1D140P10,  
F5PAE140P100 (DC input)  
Operating current select  
switch setting: D

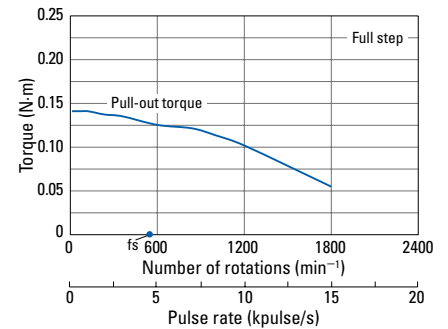

### SM5422-7241 SM5422-7211

Constant current circuit  
Source voltage: 24 VDC  
Operating current:  
0.75 A/phase, 4-phase  
energization (full step)  
 $J_L=0.94 \times 10^{-4} \text{kg} \cdot \text{m}^2$   
(use the rubber coupling)

Compatible drivers:  
FS1D140P10,  
F5PAE140P100 (DC input)  
Operating current select  
switch setting: D

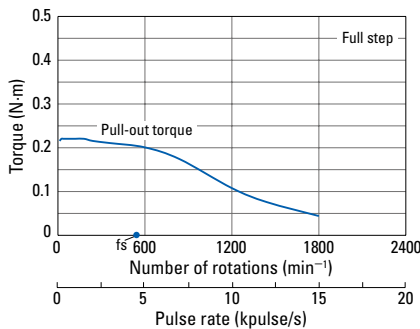

### SM5423-7241 SM5423-7211

Constant current circuit  
Source voltage: 24 VDC  
Operating current:  
0.75 A/phase, 4-phase  
energization (full step)  
 $J_L=0.94 \times 10^{-4} \text{kg} \cdot \text{m}^2$   
(use the rubber coupling)

Compatible drivers:  
FS1D140P10,  
F5PAE140P100 (DC input)  
Operating current select  
switch setting: D

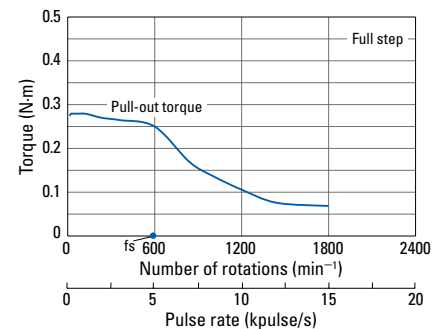

## Dimensions [Unit: mm]

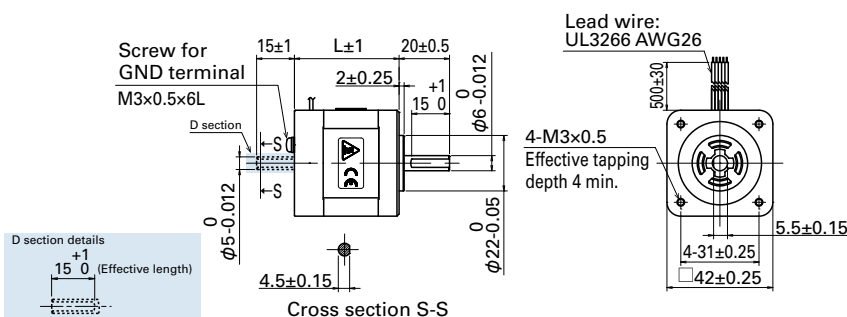

## Internal wiring

Connection method: New pentagon connection

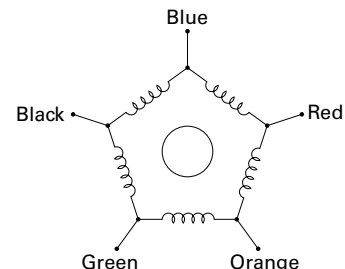



## 50 mm sq

0.72°/step **RoHS**

Lead wire type  
New pentagon connection

### Customizing

- Hollow Shaft modification
- Encoder

Varies depending on the model number and quantity. Contact us for details.

Model number		Holding torque at 4-phase energization	Rated current	Wiring resistance	Winding inductance	Rotor inertia	Mass (Weight)	Motor length (L)
Single shaft	Dual shaft	N·m min.	A/phase	Ω/phase	mH/phase	×10 <sup>-4</sup> kg·m <sup>2</sup>	kg	mm
<b>103H6500-7341</b>	<b>103H6500-7311</b>	0.225	1.4	0.54	1	0.057	0.38	39.8
<b>103H6501-7341</b>	<b>103H6501-7311</b>	0.37	1.4	0.75	1.75	0.105	0.44	48.8

### Characteristics diagram

#### 103H6500-7341 103H6500-7311

Constant current circuit  
Source voltage: 24 VDC  
Operating current:  
1.4 A/phase, 4-phase  
energization (full step)  
 $J_r=0.94 \times 10^{-4} \text{kg} \cdot \text{m}^2$   
(use the rubber coupling)  
fs: Maximum self-start  
frequency when not  
loaded

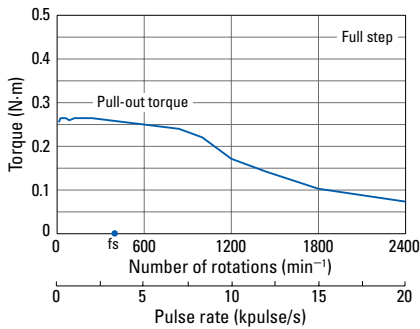

#### 103H6501-7341 103H6501-7311

Constant current circuit  
Source voltage: 24 VDC  
Operating current:  
1.4 A/phase, 4-phase  
energization (full step)  
 $J_r=0.94 \times 10^{-4} \text{kg} \cdot \text{m}^2$   
(use the rubber coupling)  
fs: Maximum self-start  
frequency when not  
loaded

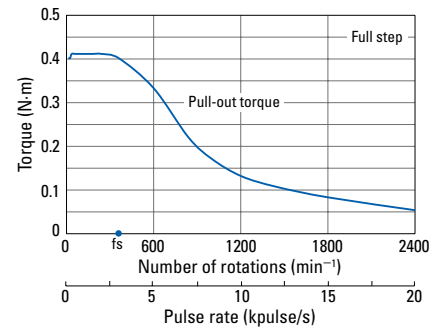

### Dimensions [Unit: mm]

#### 103H6500-7341 103H6500-7311

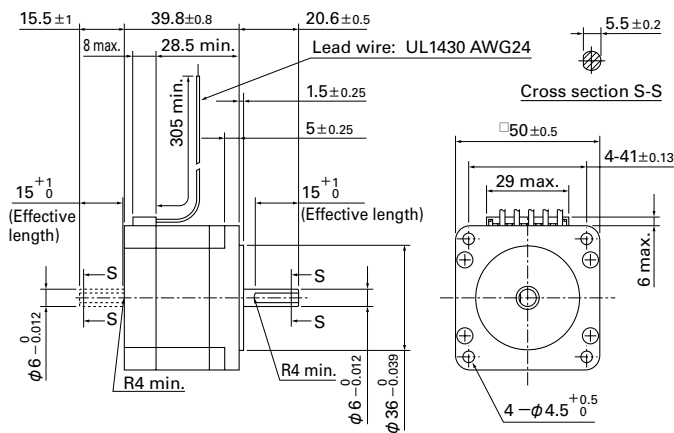

#### 103H6501-7341 103H6501-7311

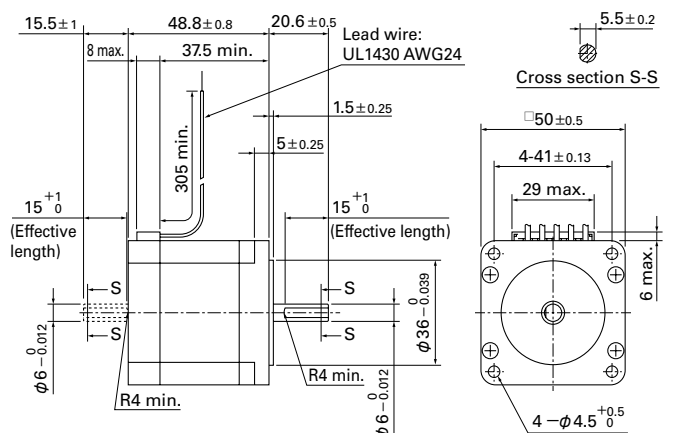

### Internal wiring

Connection method: New pentagon connection

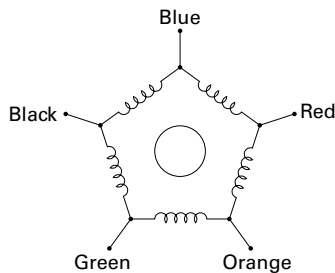

### Compatible drivers

Model number: F5PAE140P100, FS1D140P10 (DC input)  
Operating current select switch setting: 0







## 86 mm sq.

0.72°/step **RoHS** **CE** **cULus**  
 Lead wire type  
 New pentagon connection

### Customizing

**Hollow** **Shaft modification**  
**Decelerator** **Encoder** **Brake**

Varies depending on the model number and quantity. Contact us for details.

Model number		Holding torque at 4-phase energization	Rated current	Wiring resistance	Winding inductance	Rotor inertia	Mass (Weight)	Motor length (L)
Single shaft	Dual shaft	N·m min.	A/phase	Ω/phase	mH/phase	×10 <sup>-4</sup> kg·m <sup>2</sup>	kg	mm
<b>SM5861-7241</b>	<b>SM5861-7211</b>	2.3	0.75	3.9	25	1.48	1.75	66
<b>SM5862-7241</b>	<b>SM5862-7211</b>	4.4	0.75	6.4	44	3	2.9	96.5
<b>SM5863-7241</b>	<b>SM5863-7211</b>	6.8	0.75	8.8	67	4.5	4	127
<b>SM5861-8241</b>	<b>SM5861-8211</b>	2.3	1.4	1.3	7	1.48	1.75	66
<b>SM5862-8241</b>	<b>SM5862-8211</b>	4.4	1.4	2	13	3	2.9	96.5
<b>SM5863-8241</b>	<b>SM5863-8211</b>	6.8	1.4	2.8	20	4.5	4	127

## Characteristics diagram

### SM5861-7241 SM5861-7211

Constant current circuit  
 Source voltage: 100 VAC  
 Operating current:  
 0.75 A/phase, 4-phase energization (full step)  
 $J_L=7.4 \times 10^{-4} \text{kg}\cdot\text{m}^2$   
 (use the rubber coupling)

Compatible drivers:  
 F5PAA075P100 (AC input)  
 Operating current select switch setting: 0

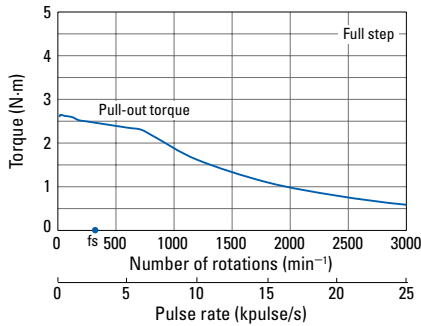

### SM5862-7241 SM5862-7211

Constant current circuit  
 Source voltage: 100 VAC  
 Operating current:  
 0.75 A/phase, 4-phase energization (full step)  
 $J_L=15.3 \times 10^{-4} \text{kg}\cdot\text{m}^2$   
 (use the rubber coupling)

Compatible drivers:  
 F5PAA075P100 (AC input)  
 Operating current select switch setting: 0

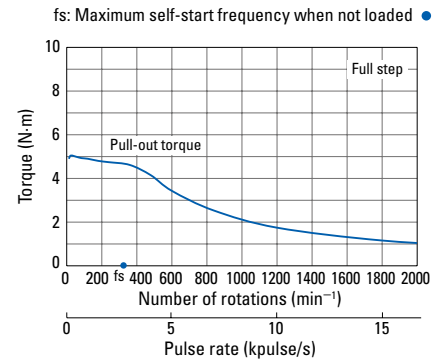

### SM5863-7241 SM5863-7211

Constant current circuit  
 Source voltage: 100 VAC  
 Operating current:  
 0.75 A/phase, 4-phase energization (full step)  
 $J_L=41.3 \times 10^{-4} \text{kg}\cdot\text{m}^2$   
 (use the rubber coupling)

Compatible drivers:  
 F5PAA075P100 (AC input)  
 Operating current select switch setting: 0

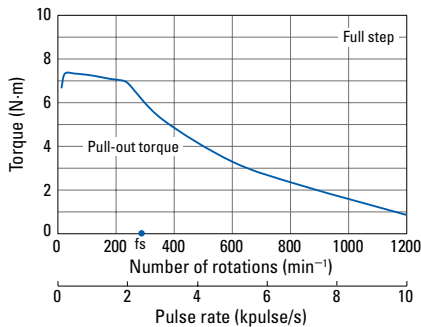

### SM5861-8241 SM5861-8211

Constant current circuit  
 Source voltage: 24 VDC  
 Operating current:  
 1.4 A/phase, 4-phase energization (full step)  
 $J_L=7.4 \times 10^{-4} \text{kg}\cdot\text{m}^2$   
 (use the rubber coupling)

Compatible drivers:  
 FS1D140P10,  
 F5PAE140P100 (DC input)  
 Operating current select switch setting: 0

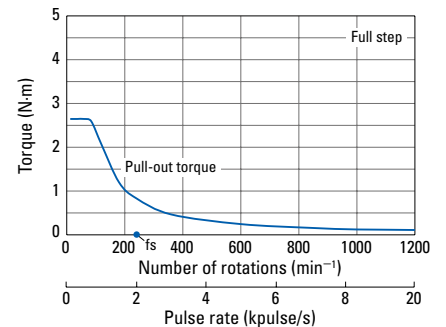

### SM5862-8241 SM5862-8211

Constant current circuit  
 Source voltage: 24 VDC  
 Operating current:  
 1.4 A/phase, 4-phase energization (full step)  
 $J_L=15.3 \times 10^{-4} \text{kg}\cdot\text{m}^2$   
 (use the rubber coupling)

Compatible drivers:  
 FS1D140P10,  
 F5PAE140P100 (DC input)  
 Operating current select switch setting: 0

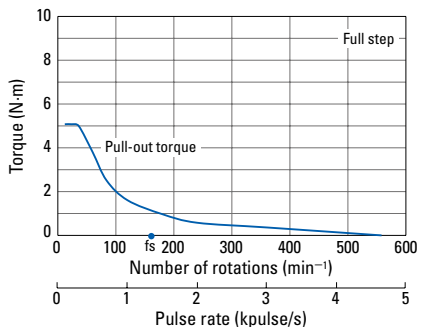

### SM5863-8241 SM5863-8211

Constant current circuit  
 Source voltage: 100 VAC  
 Operating current:  
 1.4 A/phase, 4-phase energization (full step)  
 $J_L=41.3 \times 10^{-4} \text{kg}\cdot\text{m}^2$   
 (use the rubber coupling)

Compatible drivers:  
 Driver is not included. If you require assistance finding a driver, contact us for details.

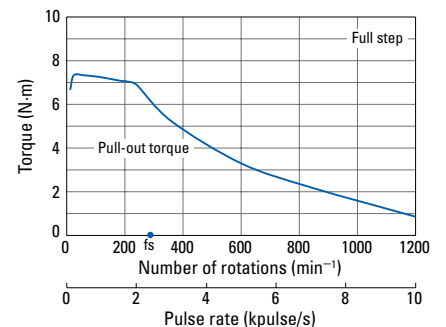

## Dimensions [Unit: mm]

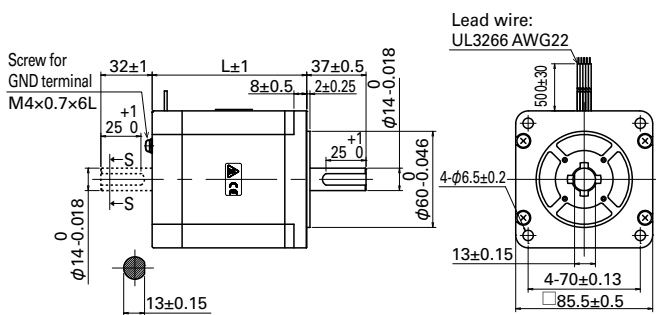

Cross section S-S

## Internal wiring

Connection method: New pentagon connection

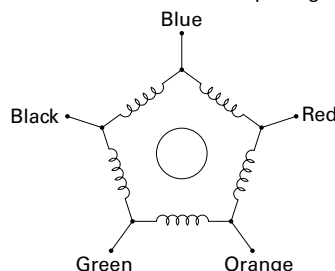

# Allowable Radial/Thrust Load

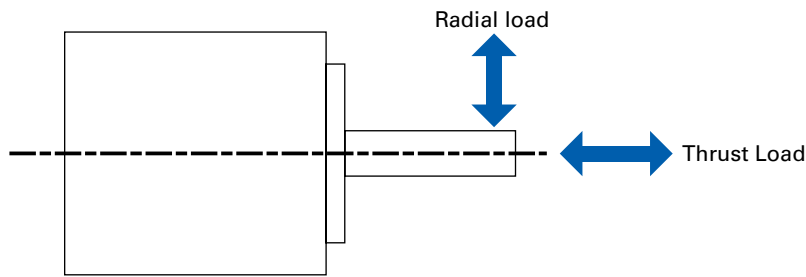

Motor size	Model number	Radial load (N)				Thrust Load (N)
		Distance from end of shaft				
		0 mm	5 mm	10 mm	15 mm	
<b>28 mm sq.</b>	SH528□-72□1	42	48	55	—	3
<b>42 mm sq.</b>	SM542□-□2□1 SF542□-82□1	52	66	90	140	10
<b>50 mm sq.</b>	103H650□-73□1	76	94	123	179	15
<b>60 mm sq.</b>	SM560□-□2□1	170	205	258	347	20
<b>86 mm sq.</b>	SM586□-□2□1	200	200	200	200	60

# Internal Wiring and Rotation Direction

## Internal wire connection

Connection method:  
New pentagon connection

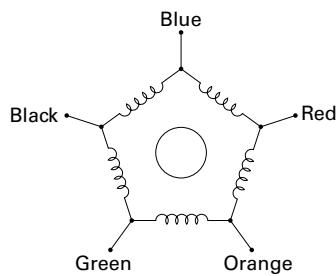

## Direction of motor rotation

When excited by a direct current in the order shown below, the direction of rotation is clockwise as viewed from the output shaft side.

Lead wire color	Exciting order									
	1	2	3	4	5	6	7	8	9	10
Blue			+	+	+			-	-	-
Red	-	-			+	+	+			-
Orange		-	-	-			+	+	+	
Green	+			-	-	-		+	+	+
Black	+	+	+			-	-	-		

## General specifications

Motor model number	SH528□	SM542□	103H650□	SM560□	SM586□
Type	—	S1 (continuous operation)	—	S1 (continuous operation)	
Operating ambient temperature	−10°C to +50°C	−10°C to +40°C	−10°C to +50°C	−10°C to +40°C	
Storage temperature	−20°C to +65°C	−20°C to +60°C	−20°C to +65°C	−20°C to +60°C	
Operating ambient humidity	20 to 90% RH (no condensation)	95% RH max.: Under 40°C (no condensation)	20 to 90% RH (no condensation)	95% RH max.: Under 40°C (no condensation)	
Storage humidity	5 to 95% RH (no condensation)	95% RH max.: Under 40°C, 57% RH max.: Under 50°C, 35% RH max.: Under 60°C (no condensation)	5 to 95% RH (no condensation)	95% RH max.: Under 40°C, 57% RH max.: Under 50°C, 35% RH max.: Under 60°C (no condensation)	
Operation altitude	1000 m or less above sea level				
Vibration resistance	Vibration frequency 10 to 500 Hz, total amplitude 1.52 mm (10 to 70 Hz), vibration acceleration 150 m/s <sup>2</sup> (70 to 500 Hz), sweep time 15 min/cycle, 12 sweeps in each X, Y and Z direction.				
Impact resistance	500 m/s <sup>2</sup> of acceleration for 11 ms with half-sine wave applying three times for X, Y and Z axes each, 18 times in total.				
Thermal class	B (+130°C)	F (+155°C)	B (+130°C)	F (+155°C)	F (+155°C)
Withstandable voltage	At normal temperature and humidity, no failure with 500 VAC @50/60 Hz applied for one minute between motor winding and frame.	At normal temperature and humidity, no failure with 1500 VAC @50/60 Hz applied for one minute between motor winding and frame.			
Insulation resistance	At normal temperature and humidity, not less than 100 MΩ between motor winding and frame by 500 VDC megger.				
Protection grade	IP40				
Winding temperature rise *1	80 K max.	85 K max.	80 K max.	85 K max.	85 K max.
Static angle error	±0.09°	±0.09°	±0.09°	±0.09°	±0.09°
Thrust play *2	0.075 mm max. (load: 1.5 N)	0.075 mm max. (load: 5 N)	0.075 mm max. (load: 10 N)	0.075 mm max. (load: 10 N)	0.075 mm max. (load: 10 N)
Radial play *3	0.025 mm max. (load: 5 N)	0.025 mm max. (load: 5 N)	0.025 mm max. (load: 5 N)	0.025 mm max. (load: 5 N)	0.025 mm max. (load: 5 N)
Shaft runout	0.025 mm	0.025 mm	0.025 mm	0.025 mm	0.025 mm
Concentricity of mounting pilot relative to shaft	φ0.05 mm	φ0.05 mm	φ0.075 mm	φ0.075 mm	φ0.075 mm
Squareness of mounting surface relative to shaft	0.1 mm	0.1 mm	0.1 mm	0.1 mm	0.15 mm
Direction of motor mounting	Can be freely mounted vertically or horizontally				

\*1: Based on SANYO DENKI standard

\*2: Thrust play: Shaft displacement under axial load.

\*3: Radial play: Shaft displacement under radial load applied 1/3rd of the length from the end of the shaft.

### Safety standards

Model number: SM542□, SM560□, SM586□

CE marking	Directives	Applicable standard
	Low-voltage directives (2014/35/EU)	EN60034-1, EN60034-5

UL	Acquired standards	Applicable standard	File No.
	UL	UL1004-1, UL1004-6	E179832 (PRHZ2)
	cUL *4	CSA C22.2 No.100	E179832 (PRHZ8)

\*4: SM542□ type is not cUL compliant.

# Linear Actuator Stepping Motors



## Features

- System Miniaturization  
This product incorporates a ball screw inside the stepping motor to make it compact. This allows equipment size to be reduced.
- Large Thrust
- Long Stroke Length

## Application

Semiconductor manufacturing equipment, general industrial machinery, machine tools application and transport equipment.

Please make sure to prepare linear guide structure with non-rotating mechanism to support radial load and prevent screw shaft from rotating. It is mandatory to generate linear motion.

## Specifications

Model number	SL5421-7241	SL5421-72XB41	SL5601-8241	SL5601-82XB41
Brake	Without	With	Without	With
Motor size	42 mm		60 mm	
Rated current	0.75 A/phase		1.4 A/phase	
Stroke	50 mm		80 mm	
Thrust	370 N		450 N	
Brake retention	Without	370 N	Without	450 N
Speed	48 mm/s		64 mm/s	
Resolution	0.004 mm		0.008 mm	
Positioning repeatability	±0.02 mm			
Lost motion	0.1 mm			
Mass	0.65 kg	0.8 kg	1.4 kg	1.7 kg
Standard combined stepping driver model	FS1D140P10 (Specifications ▶ p. 100))			

• Connection method: New pentagon connection

## Characteristics diagram

Model number: SL5421-72□□

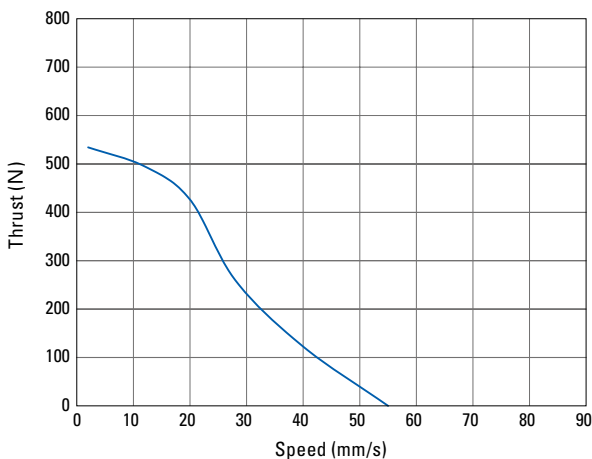

### Drive condition

Driver: FS1D140P10  
Source current: 24 VDC  
Excitation current: 0.75 A/phase  
Excitation mode: 4-phase excitation (Full step)

Model number: SL5601-82□□

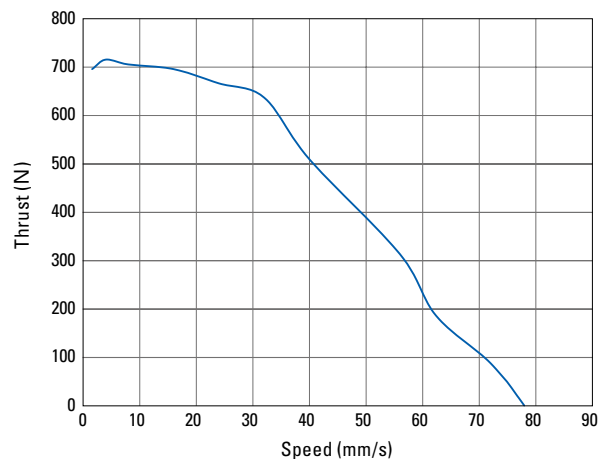

### Drive condition

Driver: FS1D140P10  
Source current: 24 VDC  
Excitation current: 1.4 A/phase  
Excitation mode: 4-phase excitation (Full step)

## Linear Actuator Stepping Motor dimensions (Unit: mm)

Dimensions for models with electromagnetic brake.

### 42 mm sq.

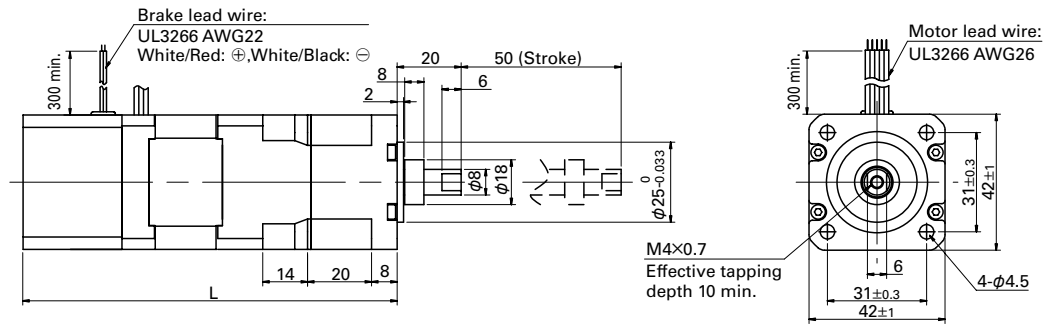

Set model number	Brake	Motor+brake length (L)
SL5421-7241	Without	87 ± 2
SL5421-72XB41	With	117 ± 2

### 60 mm sq.

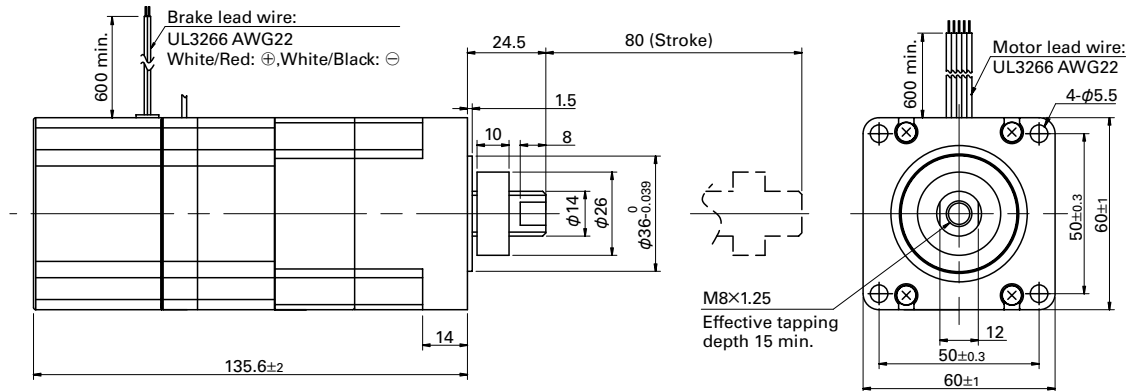

Set model number	Brake
SL5601-8241	Without
SL5601-82XB41	With

# Stepping Motors for Vacuum Environments Customized Products



## Features

- These stepping motors can be driven in a vacuum environment without requiring a vacuum feedthrough. Use as vacuum-compatible actuators while retaining the stepping motor benefits of easy high-precision open-loop control.
- We can customize for a wide range of environment pressures, from low to ultra-high vacuums.
- Available baked at 200°C.
- Size is similar to that of typical stepping motors.

## Intended Operating Pressure

Low vacuum			Medium vacuum			High vacuum			Ultra-high vacuum				
$10^5$	$10^4$	$10^3$	$10^2$	$10^1$	1	$10^{-1}$	$10^{-2}$	$10^{-3}$	$10^{-4}$	$10^{-5}$	$10^{-6}$	$10^{-7}$	$10^{-8}$ [Pa]

## Applications

Ideal for the following applications. Contact us to discuss your particular application environment needs.

- Semiconductor manufacturing equipment
- Satellite robotics
- Electron microscopes
- Large-scale research facilities such as accelerators, synchrotron radiation analysis equipment, etc.

## Motor size

42 mm sq. to 86 mm sq.



# Safety Precautions

The products in this catalog are designed to be used with general industrial devices. When using them, pay sufficient attention to the following points.

- Read the Operation Manual thoroughly prior to placement, assembly and/or operation in order to use the product properly.
- Refrain from modifying or processing the product in any way.
- Contact us or your point of sale for placement or maintenance services of the product.
- Regarding the following uses of the product, contact us or your point of sale for the special care required for operation, maintenance and management such as multiplexing the system, installing an emergency electric generator set, and so forth.

- ① Use in medical equipment that may have an effect on human life or the human body
- ② Use in transportation systems or transport-related equipment such as trains or elevators, that may have an effect on human life or the human body
- ③ Use in computer systems that may have an impact on society or on the public
- ④ Use in other devices that have a major impact on human safety or on maintaining public operations

- In addition to the above, contact us or your point of sale for use in an environment where vibrations occur, such as in automobiles or transport.
- For use in space, aviation, or nuclear power-related applications, contact us or your point of sale.
- The products shown in this catalog are subject to Japanese Export Control Law. Diversion contrary to the law of exporting country is prohibited.

# Safety Precautions

## Indication by (Warning Label) on the Product

Either or all of the following indications are expressed by the Warning Labels depending on the type of driver or stepping motor.



This label is affixed near high voltage parts such as the electrically charged or cover-protected section, warning of the places where it is likely to cause an electric shock.



This label is affixed near the GND terminals of the driver for which grounding is required, recommending that the terminals should be well grounded.



This label is affixed for the driver to which the power source is applied in the voltage exceeding the safety standard, drawing attention to the risk of the electric shock.



Indicates that the stepping motor may get hot, resulting in burns.



Indicates that the stepping motor should be grounded.

## Safety Ranks of the Cautions

Following four ranks are provided.



**DANGER** Improper operations or use is most likely to result in serious injury or death.



**CAUTION** Improper operations or use is likely to result in average or minor injury, or in property damage.

In spite of the cautions with the CAUTION label, it may cause serious results. Either the contents or the labels is describing important cautions to be followed inevitably.



**PROHIBITED** Indicates what must not be done.



**COMPULSORY** Indicates what must be done.



### General matters

1. Do not use the product in an explosive, flammable or corrosive atmosphere, watery place or near a combustible material. Doing so may cause injury or fire.
2. Have a person with expert knowledge on hand for performing the transportation, placement, wiring, operation, maintenance or inspection of the product. Without such knowledge, it may cause an electric shock, injury or fire.
3. Do not work on wiring, maintenance servicing or inspection with the electric power on. Perform either of those five minutes after turning the power off. Failure to do so may cause an electric shock.
4. When the protective functions of the product is activated, turn the power off immediately and eliminate the cause. If continuing the operation without eliminating the cause, the product may operate improperly and cause injury or a breakdown of the system devices.
5. Stepping motor may run out of order when operating and stopping depending on the magnitude of the load. Put the product into use after confirming with the adequate trial test operation in the maximum load conditions that the product operates reliably. Doing otherwise may cause a breakdown of the system. (Should the product run out of order in the use to drive upward/downward, it may cause a fall of the load.)
6. Do not touch the internal parts of the driver. Doing so may cause an electric shock.

### Wiring

7. Do not connect the stepping motor directly to a commercial power outlet. Doing so may cause an electric shock, injury or fire. Power should be supplied to the stepping motor through the driving circuit (except for synchronous motors).
8. Use an electric power source within the rated input voltage. Using otherwise may cause fire or an electric shock.
9. Connect the driver and stepping motor to the ground. Using without grounding may cause an electric shock.
10. Do not harm, forcibly put a stress, or load a heavy article on the cable or get it caught between the articles. Doing so may cause an electric shock.
11. Perform wiring with the power cable as instructed by the wiring diagram or the Operation Manual. Doing otherwise may cause an electric shock or fire.
12. Do not move the stepping motor cable, as it is not a movable cable. Doing so may result in electric shock, injury, or fire.

### Operation

13. Be sure not to touch the rotating part of the stepping motor during its operation. Touching it may cause injury.
14. Do not reach or touch the electric terminals while electric power is on. Doing so may cause an electric shock.
15. Never disconnect any of the connectors while electric power is on. Doing so may cause an electric shock and corruption.
16. Do not operate this product with live parts exposed. Doing so may result in electric shock.
17. If smoke, fire, unusual smells, or unusual sounds are produced from the driver or stepping motor, turn off the power and stop using this product immediately. Not doing so may result in electric shock, injury, or fire.



### General matters

1. Prior to placement, operation, maintenance servicing or inspection, be sure to read the Operation Manual and follow the instructions to perform. Failure to follow the instructions may cause an electric shock, injury or fire.
2. Do not use the driver or the stepping motor in conditions that exceed the specification values. Doing so may cause an electric shock, injury or fire.
3. Do not insert a finger or an object into the opening of the product. Doing so may cause an electric shock, injury or fire.

4. Do not use a damaged driver or stepping motor. Doing so may cause injury, fire or the like.
5. Use the driver and stepping motor in the designated combination. Using otherwise may cause fire or a trouble.
6. Be careful when the temperature rises in the operating driver, stepping motor or peripheral devices. Failure to be careful may cause a burn.
7. Never disassemble, repair, modify, or remanufacture this product. Doing so may result in electric shock, injury, or fire.
8. Do not remove the rating plate. Using this product with an incorrect rating may result in fire.
9. Be careful that this product does not fall or tip over when handling, as this can be dangerous.

### Unpacking

10. Confirm that the bottom and top of the box are facing correctly while unpacking. Failure to do so may cause injury.
11. Confirm that the product is the one that you have ordered. Installing an incorrect product may cause a breakdown.

### Wiring

12. Do not measure the insulation resistance or dielectric voltage of the product. Doing so may cause a breakdown. Contact us or your point of sale instead, if such a measurement is required.
13. Perform wiring conforming to the technical standards of electric facility or the internal rule. Doing otherwise may cause burning or fire.
14. Ensure that wiring has been correctly done. Incorrect wiring may cause the stepping motor to run out of control, resulting in injury.
15. Insulate the attached condenser and external resistance connection terminals. Failure to do so may cause an electric shock.

### Placement

16. Do not climb or attach a heavy article on the product. Doing so may cause injury.
17. Make sure that the intake and exhaust ports are not blocked or stuffed by foreign particles. Doing so may cause fire.
18. Make sure to use the specified driver mounting direction. Failure to do so will result in product failure.
19. Keep a distance as instructed by the Operation Manual for the driver from the inner surface of the control console or other devices. Failure to do so may cause trouble.
20. Place the product with great care so as to prevent from danger such as a tumble or a turnover.
21. Mount the product on an incombustible material such as metal. Failure to do so may cause fire, injury, or device breakdown.
22. Do not place combustible material around this product. Failure to do so may result in fire or burns.
23. Be sure to provide an adequate ventilation path when installing this product, and do not block the intake and exhaust ports. Failure to do so may result in electric shock, fire, or device breakdown.
24. Confirm the rotating direction before connecting with the mechanical device. Failure to do so may cause injury or a breakdown.
25. Do not touch the motor output spindle (including the key slot and gears) with your bare hand. Doing so may cause injury.
26. Make sure not to apply force to the lead wire or cables.

### Operation

27. The stepping motor is not equipped with any protective device. Take protective measures using an over-current protective relay, a ground fault interrupter, a protective device from excess temperature, and an emergency stopping device. Failure to do so may cause injury or fire.
28. Do not touch the product for a period after the power is on or has been turned off, since the driver and stepping motor remain at a high temperature. Doing so may cause burns. In particular, the temperature rises considerably of the stepping motor depending on the operating conditions.  
Do not allow the motor surface to exceed the following temperatures:
  - Thermal class F (+155°C) stepping motors: 125°C
  - Thermal class B (+130°C) stepping motors: 100°C
  - Regardless of thermal class, encoder equipped stepping motors: 85°C, stepping motors with built in drivers: 70°C, stepping

motors for vacuum environments: 150°C

29. Stop operations immediately when an emergency occurs. Failure to do so may cause an electric shock, injury or fire.
30. Do not change adjustment to an extreme, for such a change results in unstable operation. Doing so may cause injury.
31. During trial operations, firmly stabilize the stepping motor, and confirm operations by disconnecting from the mechanical system before connecting with it. Failure to do so may cause injury.
32. When the alarm has been activated, eliminate the cause and ensure safety before resuming operations. Failure to do so may cause injury.
33. When the electric power recovers after a momentary interruption, do not approach the devices because the system may restart operation by itself. (Set the system so as to secure the safety even when it restarts on such occasions.) Failure to do so may cause injury.
34. Confirm that the electric power supply properly conforms to the product specifications. Failure to do so may cause a breakdown.
35. The brake mechanism of the motor with the electro-magnetic brake is used to hold the movable section and the motor position. Do not use it as a safety measure. Doing so may cause the breakdown of the system.
36. Firmly stabilize the key when operating the motor with the key individually. Failure to do so may cause injury.

#### **Maintenance**

37. Be careful when performing maintenance services or inspection regarding the temperature which rises highly in the driver and stepping motor frame. Failure to do so may cause burns.
38. It is recommended to replace the electrolytic condenser of the driver with a new one for securing the preventive measure after using for 5 years (the expected life in an average operating environment of 40°C). The expected life of the fuse is 10 years in an average operating environment of 40°C. Thus, periodical replacement is recommended.
39. Contact us or your point of sale for repair. If the product is disassembled by the user, it may become inoperable.

#### **Transportation**

40. Handle the product with care during transportation so as to prevent from dangers such as tumbling or overturning.
41. Do not hold with the cable or the motor spindle. Doing so may cause trouble or injury.

#### **Retirement**

42. When scrapping the driver or stepping motor, handle it as general industrial waste.

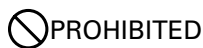

---

#### **Storage**

1. Avoid storing this product in places exposed to rain or water drops, or in an environment with hazardous gas or liquid. Failure to do so may cause trouble.

#### **Maintenance**

2. Do not disassemble or repair the product. Doing so may cause fire or an electric shock.

#### **General matters**

3. Do not remove the rating plate. Using this product with the incorrect rating may result in fire.



---

#### **Storage**

1. Store the product in a location that is not exposed to sunlight, at a temperature and humidity within the product specifications.
2. If the driver has been stored for a long period (3 years or longer as a general guide), contact us. The capacitance may have decreased with the electrolytic condenser due to the long period storage, which may cause trouble.

#### **Operation**

3. Install an external emergency stop circuit to turn the power off in the event that operation must be instantly halted.
4. Operate this product within the specified ambient temperature and humidity.

#### **Transportation**

5. Excess loading of the product on the carrier may cause the load to fall in pieces. Follow the instructions given outside the package.

# Index by Model No.

Gear...Low backlash gear or spur gear, H gear...harmonic gear

## AC Input Set Models

### ■ Set Models 100 VAC series

Model number	Motor size (mm)	Model	Rated current (A/phase)	Single shaft/ Dual shaft	Page
FA511M421D	42×42×35	Standard	0.35	Dual shaft	p. 17
FA511M421D-CX10	42×42×65.4	Gear	0.35	Dual shaft	p. 19
FA511M421D-CX20	42×42×65.4	Gear	0.35	Dual shaft	p. 19
FA511M421D-CX3.6	42×42×65.4	Gear	0.35	Dual shaft	p. 19
FA511M421D-CX30	42×42×65.4	Gear	0.35	Dual shaft	p. 19
FA511M421D-CX36	42×42×65.4	Gear	0.35	Dual shaft	p. 19
FA511M421D-CX7.2	42×42×65.4	Gear	0.35	Dual shaft	p. 19
FA511M421D-HX100	42×42×74.4	H gear	0.35	Dual shaft	p. 22
FA511M421D-HX30	42×42×74.4	H gear	0.35	Dual shaft	p. 22
FA511M421D-HX50	42×42×74.4	H gear	0.35	Dual shaft	p. 22
FA511M421S	42×42×35	Standard	0.35	Single shaft	p. 17
FA511M421S-CX10	42×42×65.4	Gear	0.35	Single shaft	p. 19
FA511M421S-CX20	42×42×65.4	Gear	0.35	Single shaft	p. 19
FA511M421S-CX3.6	42×42×65.4	Gear	0.35	Single shaft	p. 19
FA511M421S-CX30	42×42×65.4	Gear	0.35	Single shaft	p. 19
FA511M421S-CX36	42×42×65.4	Gear	0.35	Single shaft	p. 19
FA511M421S-CX7.2	42×42×65.4	Gear	0.35	Single shaft	p. 19
FA511M421S-HX100	42×42×74.4	H gear	0.35	Single shaft	p. 22
FA511M421S-HX30	42×42×74.4	H gear	0.35	Single shaft	p. 22
FA511M421S-HX50	42×42×74.4	H gear	0.35	Single shaft	p. 22
FA511M421S-XB	42×42×68	Brake	0.35	Single shaft	p. 24
FA511M421S-XE	42×42×51.3	Encoder	0.35	Single shaft	p. 26
FA511M422D	42×42×41	Standard	0.35	Dual shaft	p. 17
FA511M422S	42×42×41	Standard	0.35	Single shaft	p. 17
FA511M422S-XB	42×42×74.3	Brake	0.35	Single shaft	p. 24
FA511M422S-XE	42×42×57.6	Encoder	0.35	Single shaft	p. 26
FA511M423D	42×42×49	Standard	0.35	Dual shaft	p. 17
FA511M423S	42×42×49	Standard	0.35	Single shaft	p. 17
FA511M423S-XB	42×42×82	Brake	0.35	Single shaft	p. 24
FA511M423S-XE	42×42×65.3	Encoder	0.35	Single shaft	p. 26
FA512M601D	60×60×49	Standard	0.75	Dual shaft	p. 17
FA512M601D-CX10	60×60×94.8	Gear	0.75	Dual shaft	p. 20
FA512M601D-CX20	60×60×94.8	Gear	0.75	Dual shaft	p. 20
FA512M601D-CX3.6	60×60×94.8	Gear	0.75	Dual shaft	p. 20
FA512M601D-CX30	60×60×94.8	Gear	0.75	Dual shaft	p. 20
FA512M601D-CX36	60×60×94.8	Gear	0.75	Dual shaft	p. 20
FA512M601D-CX7.2	60×60×94.8	Gear	0.75	Dual shaft	p. 20
FA512M601D-HX100	60×60×116.3	H gear	0.75	Dual shaft	p. 22
FA512M601D-HX50	60×60×116.3	H gear	0.75	Dual shaft	p. 22
FA512M601S	60×60×49	Standard	0.75	Single shaft	p. 17
FA512M601S-CX10	60×60×94.8	Gear	0.75	Single shaft	p. 20
FA512M601S-CX20	60×60×94.8	Gear	0.75	Single shaft	p. 20
FA512M601S-CX3.6	60×60×94.8	Gear	0.75	Single shaft	p. 20
FA512M601S-CX30	60×60×94.8	Gear	0.75	Single shaft	p. 20
FA512M601S-CX36	60×60×94.8	Gear	0.75	Single shaft	p. 20
FA512M601S-CX7.2	60×60×94.8	Gear	0.75	Single shaft	p. 20
FA512M601S-HX100	60×60×116.3	H gear	0.75	Single shaft	p. 22
FA512M601S-HX50	60×60×116.3	H gear	0.75	Single shaft	p. 22
FA512M601S-XB	60×60×91.4	Brake	0.75	Single shaft	p. 24
FA512M601S-XE	60×60×65.6	Encoder	0.75	Single shaft	p. 26
FA512M602D	60×60×60	Standard	0.75	Dual shaft	p. 17
FA512M602S	60×60×60	Standard	0.75	Single shaft	p. 17
FA512M602S-XB	60×60×102.6	Brake	0.75	Single shaft	p. 24
FA512M602S-XE	60×60×76.8	Encoder	0.75	Single shaft	p. 26
FA512M603D	60×60×89	Standard	0.75	Dual shaft	p. 17
FA512M603S	60×60×89	Standard	0.75	Single shaft	p. 17
FA512M603S-XB	60×60×131.3	Brake	0.75	Single shaft	p. 24
FA512M603S-XE	60×60×105.5	Encoder	0.75	Single shaft	p. 26
FA512M861D	86×86×66	Standard	0.75	Dual shaft	p. 18
FA512M861D-CX10	86×86×131	Gear	0.75	Dual shaft	p. 21
FA512M861D-CX20	86×86×131	Gear	0.75	Dual shaft	p. 21

Model number	Motor size (mm)	Model	Rated current (A/phase)	Single shaft/ Dual shaft	Page
FA512M861D-CX3.6	86×86×131	Gear	0.75	Dual shaft	p. 21
FA512M861D-CX30	86×86×131	Gear	0.75	Dual shaft	p. 21
FA512M861D-CX36	86×86×131	Gear	0.75	Dual shaft	p. 21
FA512M861D-CX7.2	86×86×131	Gear	0.75	Dual shaft	p. 21
FA512M861D-HX100	86×86×148	H gear	0.75	Dual shaft	p. 23
FA512M861D-HX50	86×86×148	H gear	0.75	Dual shaft	p. 23
FA512M861S	86×86×66	Standard	0.75	Single shaft	p. 18
FA512M861S-CX10	86×86×131	Gear	0.75	Single shaft	p. 21
FA512M861S-CX20	86×86×131	Gear	0.75	Single shaft	p. 21
FA512M861S-CX3.6	86×86×131	Gear	0.75	Single shaft	p. 21
FA512M861S-CX30	86×86×131	Gear	0.75	Single shaft	p. 21
FA512M861S-CX36	86×86×131	Gear	0.75	Single shaft	p. 21
FA512M861S-CX7.2	86×86×131	Gear	0.75	Single shaft	p. 21
FA512M861S-HX100	86×86×148	H gear	0.75	Single shaft	p. 23
FA512M861S-HX50	86×86×148	H gear	0.75	Single shaft	p. 23
FA512M861S-XB	86×86×119.5	Brake	0.75	Single shaft	p. 25
FA512M861S-XE	86×86×79.5	Encoder	0.75	Single shaft	p. 27
FA512M862D	86×86×96.5	Standard	0.75	Dual shaft	p. 18
FA512M862S	86×86×96.5	Standard	0.75	Single shaft	p. 18
FA512M862S-XB	86×86×150	Brake	0.75	Single shaft	p. 25
FA512M862S-XE	86×86×110	Encoder	0.75	Single shaft	p. 27
FA512M863D	86×86×127	Standard	0.75	Dual shaft	p. 18
FA512M863S	86×86×127	Standard	0.75	Single shaft	p. 18
FA512M863S-XB	86×86×180.4	Brake	0.75	Single shaft	p. 25
FA512M863S-XE	86×86×140.5	Encoder	0.75	Single shaft	p. 27

### ■ Set Models 200 VAC series

Model number	Motor size (mm)	Model	Rated current (A/phase)	Single shaft/ Dual shaft	Page
FB511M421D	42×42×35	Standard	0.35	Dual shaft	p. 28
FB511M421D-CX10	42×42×65.4	Gear	0.35	Dual shaft	p. 30
FB511M421D-CX20	42×42×65.4	Gear	0.35	Dual shaft	p. 30
FB511M421D-CX3.6	42×42×65.4	Gear	0.35	Dual shaft	p. 30
FB511M421D-CX30	42×42×65.4	Gear	0.35	Dual shaft	p. 30
FB511M421D-CX36	42×42×65.4	Gear	0.35	Dual shaft	p. 30
FB511M421D-CX7.2	42×42×65.4	Gear	0.35	Dual shaft	p. 30
FB511M421D-HX100	42×42×74.4	H gear	0.35	Dual shaft	p. 33
FB511M421D-HX30	42×42×74.4	H gear	0.35	Dual shaft	p. 33
FB511M421D-HX50	42×42×74.4	H gear	0.35	Dual shaft	p. 33
FB511M421S	42×42×35	Standard	0.35	Single shaft	p. 28
FB511M421S-CX10	42×42×65.4	Gear	0.35	Single shaft	p. 30
FB511M421S-CX20	42×42×65.4	Gear	0.35	Single shaft	p. 30
FB511M421S-CX3.6	42×42×65.4	Gear	0.35	Single shaft	p. 30
FB511M421S-CX30	42×42×65.4	Gear	0.35	Single shaft	p. 30
FB511M421S-CX36	42×42×65.4	Gear	0.35	Single shaft	p. 30
FB511M421S-CX7.2	42×42×65.4	Gear	0.35	Single shaft	p. 30
FB511M421S-HX100	42×42×74.4	H gear	0.35	Single shaft	p. 33
FB511M421S-HX30	42×42×74.4	H gear	0.35	Single shaft	p. 33
FB511M421S-HX50	42×42×74.4	H gear	0.35	Single shaft	p. 33
FB511M421S-XB	42×42×68	Brake	0.35	Single shaft	p. 35
FB511M421S-XE	42×42×51.3	Encoder	0.35	Single shaft	p. 37
FB511M422D	42×42×41	Standard	0.35	Dual shaft	p. 28
FB511M422S	42×42×41	Standard	0.35	Single shaft	p. 28
FB511M422S-XB	42×42×74.3	Brake	0.35	Single shaft	p. 35
FB511M422S-XE	42×42×57.6	Encoder	0.35	Single shaft	p. 37
FB511M423D	42×42×49	Standard	0.35	Dual shaft	p. 28
FB511M423S	42×42×49	Standard	0.35	Single shaft	p. 28
FB511M423S-XB	42×42×82	Brake	0.35	Single shaft	p. 35
FB511M423S-XE	42×42×65.3	Encoder	0.35	Single shaft	p. 37
FB512M601D	60×60×49	Standard	0.75	Dual shaft	p. 28
FB512M601D-CX10	60×60×94.8	Gear	0.75	Dual shaft	p. 31
FB512M601D-CX20	60×60×94.8	Gear	0.75	Dual shaft	p. 31
FB512M601D-CX3.6	60×60×94.8	Gear	0.75	Dual shaft	p. 31



## Index by Model No.

Gear···Low backlash gear or spur gear, H gear···harmonic gear

Model number	Motor size (mm)	Model	Rated current (A/phase)	Single shaft/ Dual shaft	Page
FB512M601D-CX30	60×60×94.8	Gear	0.75	Dual shaft	p. 31
FB512M601D-CX36	60×60×94.8	Gear	0.75	Dual shaft	p. 31
FB512M601D-CX7.2	60×60×94.8	Gear	0.75	Dual shaft	p. 31
FB512M601D-HX100	60×60×116.3	H gear	0.75	Dual shaft	p. 33
FB512M601D-HX50	60×60×116.3	H gear	0.75	Dual shaft	p. 33
FB512M601S	60×60×49	Standard	0.75	Single shaft	p. 28
FB512M601S-CX10	60×60×94.8	Gear	0.75	Single shaft	p. 31
FB512M601S-CX20	60×60×94.8	Gear	0.75	Single shaft	p. 31
FB512M601S-CX3.6	60×60×94.8	Gear	0.75	Single shaft	p. 31
FB512M601S-CX30	60×60×94.8	Gear	0.75	Single shaft	p. 31
FB512M601S-CX36	60×60×94.8	Gear	0.75	Single shaft	p. 31
FB512M601S-CX7.2	60×60×94.8	Gear	0.75	Single shaft	p. 31
FB512M601S-HX100	60×60×116.3	H gear	0.75	Single shaft	p. 33
FB512M601S-HX50	60×60×116.3	H gear	0.75	Single shaft	p. 33
FB512M601S-XB	60×60×91.4	Brake	0.75	Single shaft	p. 35
FB512M601S-XE	60×60×65.6	Encoder	0.75	Single shaft	p. 37
FB512M602D	60×60×60	Standard	0.75	Dual shaft	p. 28
FB512M602S	60×60×60	Standard	0.75	Single shaft	p. 28
FB512M602S-XB	60×60×102.6	Brake	0.75	Single shaft	p. 35
FB512M602S-XE	60×60×76.8	Encoder	0.75	Single shaft	p. 37
FB512M603D	60×60×89	Standard	0.75	Dual shaft	p. 28
FB512M603S	60×60×89	Standard	0.75	Single shaft	p. 28
FB512M603S-XB	60×60×131.3	Brake	0.75	Single shaft	p. 35
FB512M603S-XE	60×60×105.5	Encoder	0.75	Single shaft	p. 37
FB512M861D	86×86×66	Standard	0.75	Dual shaft	p. 29
FB512M861D-CX10	86×86×131	Gear	0.75	Dual shaft	p. 32
FB512M861D-CX20	86×86×131	Gear	0.75	Dual shaft	p. 32
FB512M861D-CX3.6	86×86×131	Gear	0.75	Dual shaft	p. 32
FB512M861D-CX30	86×86×131	Gear	0.75	Dual shaft	p. 32
FB512M861D-CX36	86×86×131	Gear	0.75	Dual shaft	p. 32
FB512M861D-CX7.2	86×86×131	Gear	0.75	Dual shaft	p. 32
FB512M861D-HX100	86×86×148	H gear	0.75	Dual shaft	p. 34
FB512M861D-HX50	86×86×148	H gear	0.75	Dual shaft	p. 34
FB512M861S	86×86×66	Standard	0.75	Single shaft	p. 29
FB512M861S-CX10	86×86×131	Gear	0.75	Single shaft	p. 32
FB512M861S-CX20	86×86×131	Gear	0.75	Single shaft	p. 32
FB512M861S-CX3.6	86×86×131	Gear	0.75	Single shaft	p. 32
FB512M861S-CX30	86×86×131	Gear	0.75	Single shaft	p. 32
FB512M861S-CX36	86×86×131	Gear	0.75	Single shaft	p. 32
FB512M861S-CX7.2	86×86×131	Gear	0.75	Single shaft	p. 32
FB512M861S-HX100	86×86×148	H gear	0.75	Single shaft	p. 34
FB512M861S-HX50	86×86×148	H gear	0.75	Single shaft	p. 34
FB512M861S-XB	86×86×119.5	Brake	0.75	Single shaft	p. 36
FB512M861S-XE	86×86×79.5	Encoder	0.75	Single shaft	p. 38
FB512M862D	86×86×96.5	Standard	0.75	Dual shaft	p. 29
FB512M862S	86×86×96.5	Standard	0.75	Single shaft	p. 29
FB512M862S-XB	86×86×150	Brake	0.75	Single shaft	p. 36
FB512M862S-XE	86×86×110	Encoder	0.75	Single shaft	p. 38
FB512M863D	86×86×127	Standard	0.75	Dual shaft	p. 29
FB512M863S	86×86×127	Standard	0.75	Single shaft	p. 29
FB512M863S-XB	86×86×180.4	Brake	0.75	Single shaft	p. 36
FB512M863S-XE	86×86×140.5	Encoder	0.75	Single shaft	p. 38

### ■ Set Configuration Items Stepping Motors

Model number	Motor size (mm)	Model	Rated current (A/phase)	Single shaft/ Dual shaft	Page
SM5421-3210	42×42×35	Standard	0.35	Dual shaft	p. 17
SM5421-3240	42×42×35	Standard	0.35	Single shaft	p. 17
SM5421-32CXA10	42×42×65.4	Gear	0.35	Dual shaft	p. 19
SM5421-32CXA40	42×42×65.4	Gear	0.35	Single shaft	p. 19
SM5421-32CXB10	42×42×65.4	Gear	0.35	Dual shaft	p. 19
SM5421-32CXB40	42×42×65.4	Gear	0.35	Single shaft	p. 19
SM5421-32CXE10	42×42×65.4	Gear	0.35	Dual shaft	p. 19

Model number	Motor size (mm)	Model	Rated current (A/phase)	Single shaft/ Dual shaft	Page
SM5421-32CXE40	42×42×65.4	Gear	0.35	Single shaft	p. 19
SM5421-32CXG10	42×42×65.4	Gear	0.35	Dual shaft	p. 19
SM5421-32CXG40	42×42×65.4	Gear	0.35	Single shaft	p. 19
SM5421-32CXJ10	42×42×65.4	Gear	0.35	Dual shaft	p. 19
SM5421-32CXJ40	42×42×65.4	Gear	0.35	Single shaft	p. 19
SM5421-32CXK10	42×42×65.4	Gear	0.35	Dual shaft	p. 19
SM5421-32CXK40	42×42×65.4	Gear	0.35	Single shaft	p. 19
SM5421-32HXJ10	42×42×74.4	H gear	0.35	Dual shaft	p. 22
SM5421-32HXJ40	42×42×74.4	H gear	0.35	Single shaft	p. 22
SM5421-32HXL10	42×42×74.4	H gear	0.35	Dual shaft	p. 22
SM5421-32HXL40	42×42×74.4	H gear	0.35	Single shaft	p. 22
SM5421-32HXM10	42×42×74.4	H gear	0.35	Dual shaft	p. 22
SM5421-32HXM40	42×42×74.4	H gear	0.35	Single shaft	p. 22
SM5421-32XB40	42×42×68	Brake	0.35	Single shaft	p. 24
SM5421-32XE40	42×42×51.3	Encoder	0.35	Single shaft	p. 26
SM5422-3210	42×42×41	Standard	0.35	Dual shaft	p. 17
SM5422-3240	42×42×41	Standard	0.35	Single shaft	p. 17
SM5422-32XB40	42×42×74.3	Brake	0.35	Single shaft	p. 24
SM5422-32XE40	42×42×57.6	Encoder	0.35	Single shaft	p. 26
SM5423-3210	42×42×49	Standard	0.35	Dual shaft	p. 17
SM5423-3240	42×42×49	Standard	0.35	Single shaft	p. 17
SM5423-32XB40	42×42×82	Brake	0.35	Single shaft	p. 24
SM5423-32XE40	42×42×65.3	Encoder	0.35	Single shaft	p. 26
SM5601-7210	60×60×49	Standard	0.75	Dual shaft	p. 17
SM5601-7240	60×60×49	Standard	0.75	Single shaft	p. 17
SM5601-72CXA10	60×60×94.8	Gear	0.75	Dual shaft	p. 20
SM5601-72CXA40	60×60×94.8	Gear	0.75	Single shaft	p. 20
SM5601-72CXB10	60×60×94.8	Gear	0.75	Dual shaft	p. 20
SM5601-72CXB40	60×60×94.8	Gear	0.75	Single shaft	p. 20
SM5601-72CXE10	60×60×94.8	Gear	0.75	Dual shaft	p. 20
SM5601-72CXE40	60×60×94.8	Gear	0.75	Single shaft	p. 20
SM5601-72CXG10	60×60×94.8	Gear	0.75	Dual shaft	p. 20
SM5601-72CXG40	60×60×94.8	Gear	0.75	Single shaft	p. 20
SM5601-72CXJ10	60×60×94.8	Gear	0.75	Dual shaft	p. 20
SM5601-72CXJ40	60×60×94.8	Gear	0.75	Single shaft	p. 20
SM5601-72CXK10	60×60×94.8	Gear	0.75	Dual shaft	p. 20
SM5601-72CXK40	60×60×94.8	Gear	0.75	Single shaft	p. 20
SM5601-72HXL10	60×60×116.3	H gear	0.75	Dual shaft	p. 22
SM5601-72HXL40	60×60×116.3	H gear	0.75	Single shaft	p. 22
SM5601-72HXM10	60×60×116.3	H gear	0.75	Dual shaft	p. 22
SM5601-72HXM40	60×60×116.3	H gear	0.75	Single shaft	p. 22
SM5601-72XB40	60×60×91.4	Brake	0.75	Single shaft	p. 24
SM5601-72XE40	60×60×65.6	Encoder	0.75	Single shaft	p. 26
SM5602-7210	60×60×60	Standard	0.75	Dual shaft	p. 17
SM5602-7240	60×60×60	Standard	0.75	Single shaft	p. 17
SM5602-72XB40	60×60×102.6	Brake	0.75	Single shaft	p. 24
SM5602-72XE40	60×60×76.8	Encoder	0.75	Single shaft	p. 26
SM5603-7210	60×60×89	Standard	0.75	Dual shaft	p. 17
SM5603-7240	60×60×89	Standard	0.75	Single shaft	p. 17
SM5603-72XB40	60×60×131.3	Brake	0.75	Single shaft	p. 24
SM5603-72XE40	60×60×105.5	Encoder	0.75	Single shaft	p. 26
SM5861-7210	86×86×66	Standard	0.75	Dual shaft	p. 18
SM5861-7240	86×86×66	Standard	0.75	Single shaft	p. 18
SM5861-72CXA10	86×86×131	Gear	0.75	Dual shaft	p. 21
SM5861-72CXA40	86×86×131	Gear	0.75	Single shaft	p. 21
SM5861-72CXB10	86×86×131	Gear	0.75	Dual shaft	p. 21
SM5861-72CXB40	86×86×131	Gear	0.75	Single shaft	p. 21
SM5861-72CXE10	86×86×131	Gear	0.75	Dual shaft	p. 21
SM5861-72CXE40	86×86×131	Gear	0.75	Single shaft	p. 21
SM5861-72CXG10	86×86×131	Gear	0.75	Dual shaft	p. 21
SM5861-72CXG40	86×86×131	Gear	0.75	Single shaft	p. 21
SM5861-72CXJ10	86×86×131	Gear	0.75	Dual shaft	p. 21
SM5861-72CXJ40	86×86×131	Gear	0.75	Single shaft	p. 21
SM5861-72CXK10	86×86×131	Gear	0.75	Dual shaft	p. 21

Model number	Motor size (mm)	Model	Rated current (A/phase)	Single shaft/ Dual shaft	Page
SM5861-72CXK40	86×86×131	Gear	0.75	Single shaft	p. 21
SM5861-72HXL10	86×86×148	H gear	0.75	Dual shaft	p. 23
SM5861-72HXL40	86×86×148	H gear	0.75	Single shaft	p. 23
SM5861-72HXM10	86×86×148	H gear	0.75	Dual shaft	p. 23
SM5861-72HXM40	86×86×148	H gear	0.75	Single shaft	p. 23
SM5861-72XB40	86×86×119.5	Brake	0.75	Single shaft	p. 25
SM5861-72XE40	86×86×79.5	Encoder	0.75	Single shaft	p. 27
SM5862-7210	86×86×96.5	Standard	0.75	Dual shaft	p. 18
SM5862-7240	86×86×96.5	Standard	0.75	Single shaft	p. 18
SM5862-72XB40	86×86×150	Brake	0.75	Single shaft	p. 25
SM5862-72XE40	86×86×110	Encoder	0.75	Single shaft	p. 27
SM5863-7210	86×86×127	Standard	0.75	Dual shaft	p. 18
SM5863-7240	86×86×127	Standard	0.75	Single shaft	p. 18
SM5863-72XB40	86×86×180.4	Brake	0.75	Single shaft	p. 25
SM5863-72XE40	86×86×140.5	Encoder	0.75	Single shaft	p. 27

### ■ Drivers

Model number	Input source (V)	Rated current (A/phase)	Applicable motor sizes (mm)	Page
F5PAA035P100	AC100 to 120	0.35	42	p. 45
F5PAA075P100	AC100 to 120	0.75	60, 86	p. 45
F5PAB035P100	AC200 to 240	0.35	42	p. 45
F5PAB075P100	AC200 to 240	0.75	60, 86	p. 45

### ■ Cables, Connectors

Model number	Type	Cable length (m)	Page
FC5E0000A	Encoder extension connector set	–	p. 16
FC5E0010A	Encoder extension cable	1	p. 16
FC5E0020A	Encoder extension cable	2	p. 16
FC5E0030A	Encoder extension cable	3	p. 16
FC5S0000A	Connector for I/O signals	–	p. 16
FC5S0010A	I/O signal cable	1	p. 16
FC5S0020A	I/O signal cable	2	p. 16
FC6M0000A	Motor extension connector set	–	p. 16
FC6M0010A	Motor extension cable	1	p. 16
FC6M0020A	Motor extension cable	2	p. 16
FC6M0030A	Motor extension cable	3	p. 16
FC6M0010B	Motor extension cable	1	p. 16
FC6M0020B	Motor extension cable	2	p. 16
FC6M0030B	Motor extension cable	3	p. 16

### ■ Options

Model number	Type	Specification	Page
PBFM-U6	Connector unit for setup software	USB-RS485 converter	
SANMOTION MOTOR SETUP SOFTWARE	Setup software	Windows PC software	p. 16

## DC Input Set Models

### ■ Set Models Microstep

Model number	Motor size (mm)	Model	Rated current (A/phase)	Single shaft/ Dual shaft	Page
FAF521D	28×28×32	Standard	0.75	Dual shaft	p. 56
FAF521D-GX10	28×28×61.5	Gear	0.75	Dual shaft	p. 64
FAF521D-GX20	28×28×61.5	Gear	0.75	Dual shaft	p. 64
FAF521D-GX3.6	28×28×61.5	Gear	0.75	Dual shaft	p. 64
FAF521D-GX30	28×28×61.5	Gear	0.75	Dual shaft	p. 65
FAF521D-GX50	28×28×61.5	Gear	0.75	Dual shaft	p. 65
FAF521D-GX7.2	28×28×61.5	Gear	0.75	Dual shaft	p. 64
FAF521D-HX100	28×28×70.7	H gear	0.75	Dual shaft	p. 66
FAF521D-HX50	28×28×70.7	H gear	0.75	Dual shaft	p. 66
FAF521S	28×28×32	Standard	0.75	Single shaft	p. 56
FAF521S-GX10	28×28×61.5	Gear	0.75	Single shaft	p. 64
FAF521S-GX20	28×28×61.5	Gear	0.75	Single shaft	p. 64
FAF521S-GX3.6	28×28×61.5	Gear	0.75	Single shaft	p. 64
FAF521S-GX30	28×28×61.5	Gear	0.75	Single shaft	p. 65
FAF521S-GX50	28×28×61.5	Gear	0.75	Single shaft	p. 65
FAF521S-GX7.2	28×28×61.5	Gear	0.75	Single shaft	p. 64
FAF521S-HX100	28×28×70.7	H gear	0.75	Single shaft	p. 66
FAF521S-HX50	28×28×70.7	H gear	0.75	Single shaft	p. 66
FAF525D	28×28×51.5	Standard	0.75	Dual shaft	p. 56
FAF525S	28×28×51.5	Standard	0.75	Single shaft	p. 56
FAF541D	42×42×35	Standard	1.4	Dual shaft	p. 56
FAF541D-CX10	42×42×65.4	Gear	1.4	Dual shaft	p. 59
FAF541D-CX20	42×42×65.4	Gear	1.4	Dual shaft	p. 59
FAF541D-CX3.6	42×42×65.4	Gear	1.4	Dual shaft	p. 59
FAF541D-CX30	42×42×65.4	Gear	1.4	Dual shaft	p. 60
FAF541D-CX36	42×42×65.4	Gear	1.4	Dual shaft	p. 60
FAF541D-CX7.2	42×42×65.4	Gear	1.4	Dual shaft	p. 59
FAF541D-HX100	42×42×74.4	H gear	1.4	Dual shaft	p. 67
FAF541D-HX30	42×42×74.4	H gear	1.4	Dual shaft	p. 66
FAF541D-HX50	42×42×74.4	H gear	1.4	Dual shaft	p. 66
FAF541S	42×42×35	Standard	1.4	Single shaft	p. 56
FAF541S-CX10	42×42×65.4	Gear	1.4	Single shaft	p. 59
FAF541S-CX20	42×42×65.4	Gear	1.4	Single shaft	p. 59
FAF541S-CX3.6	42×42×65.4	Gear	1.4	Single shaft	p. 59
FAF541S-CX30	42×42×65.4	Gear	1.4	Single shaft	p. 60
FAF541S-CX36	42×42×65.4	Gear	1.4	Single shaft	p. 60
FAF541S-CX7.2	42×42×65.4	Gear	1.4	Single shaft	p. 59
FAF541S-HX100	42×42×74.4	H gear	1.4	Single shaft	p. 67
FAF541S-HX30	42×42×74.4	H gear	1.4	Single shaft	p. 66
FAF541S-HX50	42×42×74.4	H gear	1.4	Single shaft	p. 66
FAF541S-XB	42×42×68	Brake	1.4	Single shaft	p. 69
FAF542D	42×42×41	Standard	1.4	Dual shaft	p. 56
FAF542S	42×42×41	Standard	1.4	Single shaft	p. 56
FAF542S-XB	42×42×74.3	Brake	1.4	Single shaft	p. 69
FAF543D	42×42×49	Standard	1.4	Dual shaft	p. 57
FAF543S	42×42×49	Standard	1.4	Single shaft	p. 57
FAF543S-XB	42×42×82	Brake	1.4	Single shaft	p. 69
FAM561D	60×60×49	Standard	1.4	Dual shaft	p. 57
FAM561D-CX10	60×60×94.8	Gear	1.4	Dual shaft	p. 61
FAM561D-CX20	60×60×94.8	Gear	1.4	Dual shaft	p. 61
FAM561D-CX3.6	60×60×94.8	Gear	1.4	Dual shaft	p. 60
FAM561D-CX30	60×60×94.8	Gear	1.4	Dual shaft	p. 61
FAM561D-CX36	60×60×94.8	Gear	1.4	Dual shaft	p. 61
FAM561D-CX7.2	60×60×94.8	Gear	1.4	Dual shaft	p. 60
FAM561D-HX100	60×60×116.3	H gear	1.4	Dual shaft	p. 67
FAM561D-HX50	60×60×116.3	H gear	1.4	Dual shaft	p. 67
FAM561S	60×60×49	Standard	1.4	Single shaft	p. 57
FAM561S-CX10	60×60×94.8	Gear	1.4	Single shaft	p. 61
FAM561S-CX20	60×60×94.8	Gear	1.4	Single shaft	p. 61
FAM561S-CX3.6	60×60×94.8	Gear	1.4	Single shaft	p. 60
FAM561S-CX30	60×60×94.8	Gear	1.4	Single shaft	p. 61

## Index by Model No.

Gear...Low backlash gear or spur gear, H gear...harmonic gear

Model number	Motor size (mm)	Model	Rated current (A/phase)	Single shaft/ Dual shaft	Page
FAM561S-CX36	60×60×94.8	Gear	1.4	Single shaft	p. 61
FAM561S-CX7.2	60×60×94.8	Gear	1.4	Single shaft	p. 60
FAM561S-HX100	60×60×116.3	H gear	1.4	Single shaft	p. 67
FAM561S-HX50	60×60×116.3	H gear	1.4	Single shaft	p. 67
FAM561S-XB	60×60×91.4	Brake	1.4	Single shaft	p. 69
FAM562D	60×60×60	Standard	1.4	Dual shaft	p. 57
FAM562S	60×60×60	Standard	1.4	Single shaft	p. 57
FAM562S-XB	60×60×102.6	Brake	1.4	Single shaft	p. 70
FAM563D	60×60×89	Standard	1.4	Dual shaft	p. 57
FAM563S	60×60×89	Standard	1.4	Single shaft	p. 57
FAM563S-XB	60×60×131.3	Brake	1.4	Single shaft	p. 70
FAM581D	86×86×66	Standard	1.4	Dual shaft	p. 58
FAM581D-CX10	86×86×131	Gear	1.4	Dual shaft	p. 62
FAM581D-CX20	86×86×131	Gear	1.4	Dual shaft	p. 62
FAM581D-CX3.6	86×86×131	Gear	1.4	Dual shaft	p. 62
FAM581D-CX30	86×86×131	Gear	1.4	Dual shaft	p. 63
FAM581D-CX36	86×86×131	Gear	1.4	Dual shaft	p. 63
FAM581D-CX7.2	86×86×131	Gear	1.4	Dual shaft	p. 62
FAM581D-HX100	86×86×148	H gear	1.4	Dual shaft	p. 68
FAM581D-HX50	86×86×148	H gear	1.4	Dual shaft	p. 67
FAM581S	86×86×66	Standard	1.4	Single shaft	p. 58
FAM581S-CX10	86×86×131	Gear	1.4	Single shaft	p. 62
FAM581S-CX20	86×86×131	Gear	1.4	Single shaft	p. 62
FAM581S-CX3.6	86×86×131	Gear	1.4	Single shaft	p. 62
FAM581S-CX30	86×86×131	Gear	1.4	Single shaft	p. 63
FAM581S-CX36	86×86×131	Gear	1.4	Single shaft	p. 63
FAM581S-CX7.2	86×86×131	Gear	1.4	Single shaft	p. 62
FAM581S-HX100	86×86×148	H gear	1.4	Single shaft	p. 68
FAM581S-HX50	86×86×148	H gear	1.4	Single shaft	p. 67
FAM581S-XB	86×86×119.5	Brake	1.4	Single shaft	p. 70
FAM582D	86×86×96.5	Standard	1.4	Dual shaft	p. 58
FAM582S	86×86×96.5	Standard	1.4	Single shaft	p. 58
FAM582S-XB	86×86×150	Brake	1.4	Single shaft	p. 70

### ■ Set Models Full/half step

Model number	Motor size (mm)	Model	Rated current (A/phase)	Single shaft/ Dual shaft	Page
FD521D	28×28×32	Standard	0.75	Dual shaft	p. 85
FD521D-GX10	28×28×61.5	Gear	0.75	Dual shaft	p. 93
FD521D-GX20	28×28×61.5	Gear	0.75	Dual shaft	p. 93
FD521D-GX3.6	28×28×61.5	Gear	0.75	Dual shaft	p. 93
FD521D-GX30	28×28×61.5	Gear	0.75	Dual shaft	p. 94
FD521D-GX50	28×28×61.5	Gear	0.75	Dual shaft	p. 94
FD521D-GX7.2	28×28×61.5	Gear	0.75	Dual shaft	p. 93
FD521D-HX100	28×28×70.7	H gear	0.75	Dual shaft	p. 95
FD521D-HX50	28×28×70.7	H gear	0.75	Dual shaft	p. 95
FD521S	28×28×32	Standard	0.75	Single shaft	p. 85
FD521S-GX10	28×28×61.5	Gear	0.75	Single shaft	p. 93
FD521S-GX20	28×28×61.5	Gear	0.75	Single shaft	p. 93
FD521S-GX3.6	28×28×61.5	Gear	0.75	Single shaft	p. 93
FD521S-GX30	28×28×61.5	Gear	0.75	Single shaft	p. 94
FD521S-GX50	28×28×61.5	Gear	0.75	Single shaft	p. 94
FD521S-GX7.2	28×28×61.5	Gear	0.75	Single shaft	p. 93
FD521S-HX100	28×28×70.7	H gear	0.75	Single shaft	p. 95
FD521S-HX50	28×28×70.7	H gear	0.75	Single shaft	p. 95
FD525D	28×28×51.5	Standard	0.75	Dual shaft	p. 85
FD525S	28×28×51.5	Standard	0.75	Single shaft	p. 85
FD541D	42×42×35	Standard	1.4	Dual shaft	p. 85
FD541D-CX10	42×42×65.4	Gear	1.4	Dual shaft	p. 88
FD541D-CX20	42×42×65.4	Gear	1.4	Dual shaft	p. 88
FD541D-CX3.6	42×42×65.4	Gear	1.4	Dual shaft	p. 88
FD541D-CX30	42×42×65.4	Gear	1.4	Dual shaft	p. 89
FD541D-CX36	42×42×65.4	Gear	1.4	Dual shaft	p. 89

Model number	Motor size (mm)	Model	Rated current (A/phase)	Single shaft/ Dual shaft	Page
FD541D-CX7.2	42×42×65.4	Gear	1.4	Dual shaft	p. 88
FD541D-HX100	42×42×74.4	H gear	1.4	Dual shaft	p. 96
FD541D-HX30	42×42×74.4	H gear	1.4	Dual shaft	p. 95
FD541D-HX50	42×42×74.4	H gear	1.4	Dual shaft	p. 95
FD541S	42×42×35	Standard	1.4	Single shaft	p. 85
FD541S-CX10	42×42×65.4	Gear	1.4	Single shaft	p. 88
FD541S-CX20	42×42×65.4	Gear	1.4	Single shaft	p. 88
FD541S-CX3.6	42×42×65.4	Gear	1.4	Single shaft	p. 88
FD541S-CX30	42×42×65.4	Gear	1.4	Single shaft	p. 89
FD541S-CX36	42×42×65.4	Gear	1.4	Single shaft	p. 89
FD541S-CX7.2	42×42×65.4	Gear	1.4	Single shaft	p. 88
FD541S-HX100	42×42×74.4	H gear	1.4	Single shaft	p. 96
FD541S-HX30	42×42×74.4	H gear	1.4	Single shaft	p. 95
FD541S-HX50	42×42×74.4	H gear	1.4	Single shaft	p. 95
FD541S-XB	42×42×68	Brake	1.4	Single shaft	p. 98
FD542D	42×42×41	Standard	1.4	Dual shaft	p. 85
FD542S	42×42×41	Standard	1.4	Single shaft	p. 85
FD542S-XB	42×42×74.3	Brake	1.4	Single shaft	p. 98
FD543D	42×42×49	Standard	1.4	Dual shaft	p. 86
FD543S	42×42×49	Standard	1.4	Single shaft	p. 86
FD543S-XB	42×42×82	Brake	1.4	Single shaft	p. 98
FDM561D	60×60×49	Standard	1.4	Dual shaft	p. 86
FDM561D-CX10	60×60×94.8	Gear	1.4	Dual shaft	p. 90
FDM561D-CX20	60×60×94.8	Gear	1.4	Dual shaft	p. 90
FDM561D-CX3.6	60×60×94.8	Gear	1.4	Dual shaft	p. 89
FDM561D-CX30	60×60×94.8	Gear	1.4	Dual shaft	p. 90
FDM561D-CX36	60×60×94.8	Gear	1.4	Dual shaft	p. 90
FDM561D-CX7.2	60×60×94.8	Gear	1.4	Dual shaft	p. 89
FDM561D-HX100	60×60×116.3	H gear	1.4	Dual shaft	p. 96
FDM561D-HX50	60×60×116.3	H gear	1.4	Dual shaft	p. 96
FDM561S	60×60×49	Standard	1.4	Single shaft	p. 86
FDM561S-CX10	60×60×94.8	Gear	1.4	Single shaft	p. 90
FDM561S-CX20	60×60×94.8	Gear	1.4	Single shaft	p. 90
FDM561S-CX3.6	60×60×94.8	Gear	1.4	Single shaft	p. 89
FDM561S-CX30	60×60×94.8	Gear	1.4	Single shaft	p. 90
FDM561S-CX36	60×60×94.8	Gear	1.4	Single shaft	p. 90
FDM561S-CX7.2	60×60×94.8	Gear	1.4	Single shaft	p. 89
FDM561S-HX100	60×60×116.3	H gear	1.4	Single shaft	p. 96
FDM561S-HX50	60×60×116.3	H gear	1.4	Single shaft	p. 96
FDM561S-XB	60×60×91.4	Brake	1.4	Single shaft	p. 98
FDM562D	60×60×60	Standard	1.4	Dual shaft	p. 86
FDM562S	60×60×60	Standard	1.4	Single shaft	p. 86
FDM562S-XB	60×60×102.6	Brake	1.4	Single shaft	p. 99
FDM563D	60×60×89	Standard	1.4	Dual shaft	p. 86
FDM563S	60×60×89	Standard	1.4	Single shaft	p. 86
FDM563S-XB	60×60×131.3	Brake	1.4	Single shaft	p. 99
FDM581D	86×86×66	Standard	1.4	Dual shaft	p. 87
FDM581D-CX10	86×86×131	Gear	1.4	Dual shaft	p. 91
FDM581D-CX20	86×86×131	Gear	1.4	Dual shaft	p. 91
FDM581D-CX3.6	86×86×131	Gear	1.4	Dual shaft	p. 91
FDM581D-CX30	86×86×131	Gear	1.4	Dual shaft	p. 92
FDM581D-CX36	86×86×131	Gear	1.4	Dual shaft	p. 92
FDM581D-CX7.2	86×86×131	Gear	1.4	Dual shaft	p. 91
FDM581D-HX100	86×86×148	H gear	1.4	Dual shaft	p. 97
FDM581D-HX50	86×86×148	H gear	1.4	Dual shaft	p. 96
FDM581S	86×86×66	Standard	1.4	Single shaft	p. 87
FDM581S-CX10	86×86×131	Gear	1.4	Single shaft	p. 91
FDM581S-CX20	86×86×131	Gear	1.4	Single shaft	p. 91
FDM581S-CX3.6	86×86×131	Gear	1.4	Single shaft	p. 91
FDM581S-CX30	86×86×131	Gear	1.4	Single shaft	p. 92
FDM581S-CX36	86×86×131	Gear	1.4	Single shaft	p. 92
FDM581S-CX7.2	86×86×131	Gear	1.4	Single shaft	p. 91
FDM581S-HX100	86×86×148	H gear	1.4	Single shaft	p. 97
FDM581S-HX50	86×86×148	H gear	1.4	Single shaft	p. 96



Model number	Motor size (mm)	Model	Rated current (A/phase)	Single shaft/ Dual shaft	Page
FDM581S-XB	86×86×119.5	Brake	1.4	Single shaft	p. 99
FDM582D	86×86×96.5	Standard	1.4	Dual shaft	p. 87
FDM582S	86×86×96.5	Standard	1.4	Single shaft	p. 87
FDM582S-XB	86×86×150	Brake	1.4	Single shaft	p. 99

### ■ Cable with Connector (for microstep)

Model number	Type	Cable length (m)	Page
FC3P0010A	Power supply cable	1	p. 55
FC3M0010A	Stepping motor extension cable	1	p. 55
FC3S0010A	I/O signal cable	1	p. 55

### ■ Option (sold separately) Regenerative resistor (for microstep)

Model number	Type	Cable length (m)	Page
FFE-01	Regeneration resistor	0.35	p. 55

### ■ Set Configuration Items Stepping Motors (Common to microstep and full/half step)

Model number	Motor size (mm)	Model	Rated current (A/phase)	Single shaft/ Dual shaft	Page
SF5421-8211	42×42×35	Standard	1.4	Dual shaft	p. 56/p. 85
SF5421-8241	42×42×35	Standard	1.4	Single shaft	p. 56/p. 85
SF5421-82CXA11	42×42×65.4	Gear	1.4	Dual shaft	p. 59/p. 88
SF5421-82CXA41	42×42×65.4	Gear	1.4	Single shaft	p. 59/p. 88
SF5421-82CXB11	42×42×65.4	Gear	1.4	Dual shaft	p. 59/p. 88
SF5421-82CXB41	42×42×65.4	Gear	1.4	Single shaft	p. 59/p. 88
SF5421-82CXE11	42×42×65.4	Gear	1.4	Dual shaft	p. 59/p. 88
SF5421-82CXE41	42×42×65.4	Gear	1.4	Single shaft	p. 59/p. 88
SF5421-82CXG11	42×42×65.4	Gear	1.4	Dual shaft	p. 59/p. 88
SF5421-82CXG41	42×42×65.4	Gear	1.4	Single shaft	p. 59/p. 88
SF5421-82CXJ11	42×42×65.4	Gear	1.4	Dual shaft	p. 60/p. 89
SF5421-82CXJ41	42×42×65.4	Gear	1.4	Single shaft	p. 60/p. 89
SF5421-82CXX11	42×42×65.4	Gear	1.4	Dual shaft	p. 60/p. 89
SF5421-82CXX41	42×42×65.4	Gear	1.4	Single shaft	p. 60/p. 89
SF5421-82HXJ11	42×42×74.4	H gear	1.4	Dual shaft	p. 66/p. 95
SF5421-82HXJ41	42×42×74.4	H gear	1.4	Single shaft	p. 66/p. 95
SF5421-82HXL11	42×42×74.4	H gear	1.4	Dual shaft	p. 66/p. 95
SF5421-82HXL41	42×42×74.4	H gear	1.4	Single shaft	p. 66/p. 95
SF5421-82HXM11	42×42×74.4	H gear	1.4	Dual shaft	p. 67/p. 96
SF5421-82HXM41	42×42×74.4	H gear	1.4	Single shaft	p. 67/p. 96
SF5421-82XB41	42×42×68	Brake	1.4	Single shaft	p. 69/p. 98
SF5422-8211	42×42×41	Standard	1.4	Dual shaft	p. 56/p. 85
SF5422-8241	42×42×41	Standard	1.4	Single shaft	p. 56/p. 85
SF5422-82XB41	42×42×74.3	Brake	1.4	Single shaft	p. 69/p. 98
SF5423-8211	42×42×49	Standard	1.4	Dual shaft	p. 56/p. 85
SF5423-8241	42×42×49	Standard	1.4	Single shaft	p. 56/p. 85
SF5423-82XB41	42×42×82	Brake	1.4	Single shaft	p. 69/p. 98
SH5281-7211	28×28×32	Standard	0.75	Dual shaft	p. 56/p. 85
SH5281-7241	28×28×32	Standard	0.75	Single shaft	p. 56/p. 85
SH5281-72GXA1	28×28×61.5	Gear	0.75	Dual shaft	p. 64/p. 93
SH5281-72GXA4	28×28×61.5	Gear	0.75	Single shaft	p. 64/p. 93
SH5281-72GXB1	28×28×61.5	Gear	0.75	Dual shaft	p. 64/p. 93
SH5281-72GXB4	28×28×61.5	Gear	0.75	Single shaft	p. 64/p. 93
SH5281-72GXE1	28×28×61.5	Gear	0.75	Dual shaft	p. 64/p. 93
SH5281-72GXE4	28×28×61.5	Gear	0.75	Single shaft	p. 64/p. 93
SH5281-72GXG1	28×28×61.5	Gear	0.75	Dual shaft	p. 64/p. 93
SH5281-72GXG4	28×28×61.5	Gear	0.75	Single shaft	p. 64/p. 93
SH5281-72GXJ1	28×28×61.5	Gear	0.75	Dual shaft	p. 65/p. 94
SH5281-72GXJ4	28×28×61.5	Gear	0.75	Single shaft	p. 65/p. 94
SH5281-72GXL1	28×28×61.5	Gear	0.75	Dual shaft	p. 65/p. 94

Model number	Motor size (mm)	Model	Rated current (A/phase)	Single shaft/ Dual shaft	Page
SH5281-72GXL4	28×28×61.5	Gear	0.75	Single shaft	p. 65/p. 94
SH5281-72HXL1	28×28×70.7	H gear	0.75	Dual shaft	p. 66/p. 95
SH5281-72HXL4	28×28×70.7	H gear	0.75	Single shaft	p. 66/p. 95
SH5281-72HXM1	28×28×70.7	H gear	0.75	Dual shaft	p. 66/p. 95
SH5281-72HXM4	28×28×70.7	H gear	0.75	Single shaft	p. 66/p. 95
SH5285-7211	28×28×51.5	Standard	0.75	Dual shaft	p. 56/p. 85
SH5285-7241	28×28×51.5	Standard	0.75	Single shaft	p. 56/p. 85
SM5601-8211	60×60×49	Standard	1.4	Dual shaft	p. 57/p. 86
SM5601-8241	60×60×49	Standard	1.4	Single shaft	p. 57/p. 86
SM5601-82CXA11	60×60×94.8	Gear	1.4	Dual shaft	p. 60/p. 89
SM5601-82CXA41	60×60×94.8	Gear	1.4	Single shaft	p. 60/p. 89
SM5601-82CXB11	60×60×94.8	Gear	1.4	Dual shaft	p. 60/p. 89
SM5601-82CXB41	60×60×94.8	Gear	1.4	Single shaft	p. 60/p. 89
SM5601-82CXE11	60×60×94.8	Gear	1.4	Dual shaft	p. 61/p. 90
SM5601-82CXE41	60×60×94.8	Gear	1.4	Single shaft	p. 61/p. 90
SM5601-82CXG11	60×60×94.8	Gear	1.4	Dual shaft	p. 61/p. 90
SM5601-82CXG41	60×60×94.8	Gear	1.4	Single shaft	p. 61/p. 90
SM5601-82CXJ11	60×60×94.8	Gear	1.4	Dual shaft	p. 61/p. 90
SM5601-82CXJ41	60×60×94.8	Gear	1.4	Single shaft	p. 61/p. 90
SM5601-82CXX11	60×60×94.8	Gear	1.4	Dual shaft	p. 61/p. 90
SM5601-82CXX41	60×60×94.8	Gear	1.4	Single shaft	p. 61/p. 90
SM5601-82HXL11	60×60×116.3	H gear	1.4	Dual shaft	p. 67/p. 96
SM5601-82HXL41	60×60×116.3	H gear	1.4	Single shaft	p. 67/p. 96
SM5601-82HXM11	60×60×116.3	H gear	1.4	Dual shaft	p. 67/p. 96
SM5601-82HXM41	60×60×116.3	H gear	1.4	Single shaft	p. 67/p. 96
SM5601-82XB41	60×60×91.4	Brake	1.4	Single shaft	p. 69/p. 98
SM5602-8211	60×60×60	Standard	1.4	Dual shaft	p. 57/p. 86
SM5602-8241	60×60×60	Standard	1.4	Single shaft	p. 57/p. 86
SM5602-82XB41	60×60×102.6	Brake	1.4	Single shaft	p. 70/p. 99
SM5603-8211	60×60×89	Standard	1.4	Dual shaft	p. 57/p. 86
SM5603-8241	60×60×89	Standard	1.4	Single shaft	p. 57/p. 86
SM5603-82XB41	60×60×131.3	Brake	1.4	Single shaft	p. 70/p. 99
SM5861-8211	86×86×66	Standard	1.4	Dual shaft	p. 58/p. 87
SM5861-8241	86×86×66	Standard	1.4	Single shaft	p. 58/p. 87
SM5861-82CXA11	86×86×131	Gear	1.4	Dual shaft	p. 62/p. 91
SM5861-82CXA41	86×86×131	Gear	1.4	Single shaft	p. 62/p. 91
SM5861-82CXB11	86×86×131	Gear	1.4	Dual shaft	p. 62/p. 91
SM5861-82CXB41	86×86×131	Gear	1.4	Single shaft	p. 62/p. 91
SM5861-82CXE11	86×86×131	Gear	1.4	Dual shaft	p. 62/p. 91
SM5861-82CXE41	86×86×131	Gear	1.4	Single shaft	p. 62/p. 91
SM5861-82CXG11	86×86×131	Gear	1.4	Dual shaft	p. 62/p. 91
SM5861-82CXG41	86×86×131	Gear	1.4	Single shaft	p. 62/p. 91
SM5861-82CXJ11	86×86×131	Gear	1.4	Dual shaft	p. 63/p. 92
SM5861-82CXJ41	86×86×131	Gear	1.4	Single shaft	p. 63/p. 92
SM5861-82CXX11	86×86×131	Gear	1.4	Dual shaft	p. 63/p. 92
SM5861-82CXX41	86×86×131	Gear	1.4	Single shaft	p. 63/p. 92
SM5861-82HXL11	86×86×148	H gear	1.4	Dual shaft	p. 67/p. 96
SM5861-82HXL41	86×86×148	H gear	1.4	Single shaft	p. 67/p. 96
SM5861-82HXM11	86×86×148	H gear	1.4	Dual shaft	p. 68/p. 97
SM5861-82HXM41	86×86×148	H gear	1.4	Single shaft	p. 68/p. 97
SM5861-82XB41	86×86×119.5	Brake	1.4	Single shaft	p. 70/p. 99
SM5862-8211	86×86×96.5	Standard	1.4	Dual shaft	p. 58/p. 87
SM5862-8241	86×86×96.5	Standard	1.4	Single shaft	p. 58/p. 87
SM5862-82XB41	86×86×150	Brake	1.4	Single shaft	p. 70/p. 99

## Index by Model No.

### Stepping Motors

Model number	Motor size (mm)	Rated current (A/phase)	Single shaft/ Dual shaft	Page
103H6500-7311	50×50×39.8	1.4	Dual shaft	p. 110
103H6500-7341	50×50×39.8	1.4	Single shaft	p. 110
103H6501-7311	50×50×48.8	1.4	Dual shaft	p. 110
103H6501-7341	50×50×48.8	1.4	Single shaft	p. 110
SH5281-7211	28×28×32	0.75	Dual shaft	p. 108
SH5281-7241	28×28×32	0.75	Single shaft	p. 108
SH5285-7211	28×28×51.5	0.75	Dual shaft	p. 108
SH5285-7241	28×28×51.5	0.75	Single shaft	p. 108
SM5421-3211	42×42×35	0.35	Dual shaft	p. 109
SM5421-3241	42×42×35	0.35	Single shaft	p. 109
SM5421-7211	42×42×35	0.75	Dual shaft	p. 109
SM5421-7241	42×42×35	0.75	Single shaft	p. 109
SM5422-3211	42×42×41	0.35	Dual shaft	p. 109
SM5422-3241	42×42×41	0.35	Single shaft	p. 109
SM5422-7211	42×42×41	0.75	Dual shaft	p. 109
SM5422-7241	42×42×41	0.75	Single shaft	p. 109
SM5423-3211	42×42×49	0.35	Dual shaft	p. 109
SM5423-3241	42×42×49	0.35	Single shaft	p. 109
SM5423-7211	42×42×49	0.75	Dual shaft	p. 109
SM5423-7241	42×42×49	0.75	Single shaft	p. 109
SM5601-7211	60×60×49	0.75	Dual shaft	p. 111
SM5601-7241	60×60×49	0.75	Single shaft	p. 111
SM5601-8211	60×60×49	1.4	Dual shaft	p. 111
SM5601-8241	60×60×49	1.4	Single shaft	p. 111
SM5602-7211	60×60×60	0.75	Dual shaft	p. 111
SM5602-7241	60×60×60	0.75	Single shaft	p. 111
SM5602-8211	60×60×60	1.4	Dual shaft	p. 111
SM5602-8241	60×60×60	1.4	Single shaft	p. 111
SM5603-7211	60×60×89	0.75	Dual shaft	p. 111
SM5603-7241	60×60×89	0.75	Single shaft	p. 111
SM5603-8211	60×60×89	1.4	Dual shaft	p. 111
SM5603-8241	60×60×89	1.4	Single shaft	p. 111
SM5861-7211	86×86×66	0.75	Dual shaft	p. 112
SM5861-7241	86×86×66	0.75	Single shaft	p. 112
SM5861-8211	86×86×66	1.4	Dual shaft	p. 112
SM5861-8241	86×86×66	1.4	Single shaft	p. 112
SM5862-7211	86×86×96.5	0.75	Dual shaft	p. 112
SM5862-7241	86×86×96.5	0.75	Single shaft	p. 112
SM5862-8211	86×86×96.5	1.4	Dual shaft	p. 112
SM5862-8241	86×86×96.5	1.4	Single shaft	p. 112
SM5863-7211	86×86×127	0.75	Dual shaft	p. 112
SM5863-7241	86×86×127	0.75	Single shaft	p. 112
SM5863-8211	86×86×127	1.4	Dual shaft	p. 112
SM5863-8241	86×86×127	1.4	Single shaft	p. 112

### Linear Actuator Stepping Motors

Model number	Motor size (mm)	Rated current (A/phase)	Page
SL5421-7241	42×42×87	0.75	p. 115
SL5421-72XB41	42×42×117	0.75	p. 115
SL5601-8241	60×60×135.6	1.4	p. 115
SL5601-82XB41	60×60×135.6	1.4	p. 115

## ■ Selection materials for each mechanism

The diagrams below depict representative mechanisms and the points used in their selection. Notify us of the information shown here when requesting us to make a selection.

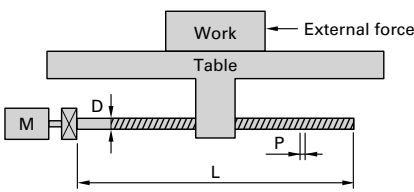
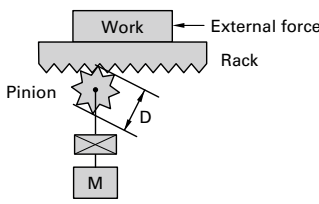
Ball screw			Rack and pinion		
					
External force	F	N	External force	F	N
Weight of work+table	W	kg	Work+rack weight	W	kg
Ball screw diameter	D	m	Pinion diameter	D	m
Ball screw length	L	m	Pinion thickness	L	m
Ball screw lead	P	m	Pinion material specific gravity	$\rho$	kg/m <sup>3</sup>
Ball screw material specific gravity	$\rho$	kg/m <sup>3</sup>	Friction coefficient	$\mu$	
Friction coefficient	$\mu$		Gear ratio*	G	
Gear ratio*	G		Mechanical efficiency	$\eta$	
Mechanical efficiency	$\eta$				

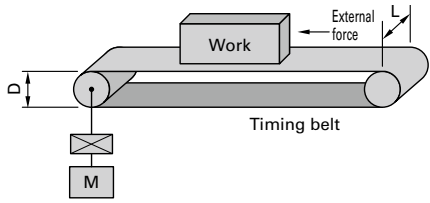
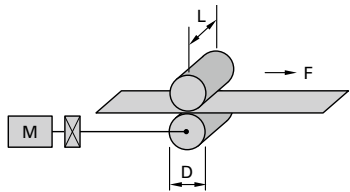
Belt drive			Roll feed		
					
External force	F	N	Sheet tension	F	N
Work+belt weight	W	kg	Roll diameter	D	m
Pulley diameter	D	m	Roll width	L	m
Pulley width	L	m	Roll material specific gravity	$\rho$	kg/m <sup>3</sup>
Pulley material specific gravity	$\rho$	kg/m <sup>3</sup>	Roll moment of inertia	J	kg · m <sup>2</sup>
Pulley moment of inertia	J	kg · m <sup>2</sup>	Gear ratio*	G	
Gear ratio*	G		Mechanical efficiency	$\eta$	
Mechanical efficiency	$\eta$				

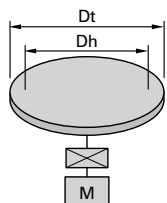
Rotary table		
		
Table weight	W	kg
Table diameter	Dt	m
Table support diameter	Dh	m
Table moment of inertia	J	kg · m <sup>2</sup>
Support area friction coefficient	$\mu$	
Gear ratio*	G	
Mechanical efficiency	$\eta$	

\*How to find the gear ratio (G)

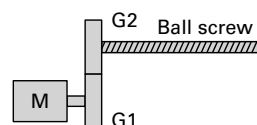

$$G = \frac{\text{Number of ball screw gears (G2)}}{\text{Number of motor gears (G1)}}$$

## ■ Precautions For Adoption

Failure to follow the precautions on the right may cause moderate injury and property damage, or in some circumstances, could lead to a serious accident.

Always follow all listed precautions.

## Cautions

- Read the accompanying Instruction Manual carefully prior to using the product.
- If applying to medical devices and other equipment affecting people's lives, please contact us beforehand and take appropriate safety measures.
- If applying to equipment that can have significant effects on society and the general public, please contact us beforehand.
- Do not use this product in an environment where vibration is present, such as in a moving vehicle or shipping vessel.
- Do not perform any retrofitting, re-engineering, or modification to this equipment.
- The products presented in this catalog are meant to be used for general industrial applications. If using for special applications related to aviation and space, nuclear power, electric power, submarine repeaters, etc., please contact us beforehand.

\*For any question or inquiry regarding the above, contact our Sales Department.

<https://www.sanyodenki.com>

### **SANYO DENKI CO., LTD.**

3-33-1 Minami-Otsuka, Toshima-ku, Tokyo 170-8451, Japan

TEL: +81 3 5927 1020

### **SANYO DENKI EUROPE SA.**

P.A. Paris Nord II, 48 Allée des Erables-VILLEPINTE, BP.57286, F-95958 ROISSY CDG Cedex, France

TEL: +33 1 48 63 26 61

### **SANYO DENKI AMERICA, INC.**

468 Amapola Avenue Torrance, CA 90501, U.S.A.

TEL: +1 310 783 5400

### **SANYO DENKI SHANGHAI CO., LTD.**

Room 2106-2110, Bldg A, Far East International Plaza, No.319, Xianxia Road, Shanghai, 200051, China

TEL: +86 21 6235 1107

#### **Beijing Branch**

Room1222, Tower B, Beijing COFCO Plaza, No.8 Jianguomennei Dajie, Dong Cheng District, Beijing 100005 China

TEL: +86 10 6522 2160

### **SANYO DENKI (H.K.) CO., LIMITED**

Room 2305, 23/F, South Tower, Concordia Plaza, 1 Science Museum Road, TST East, Kowloon, Hong Kong

TEL: +852 2312 6250

### **SANYO DENKI TAIWAN CO., LTD.**

N-711, 7F, Chia Hsin 2nd Bldg., No.96, Sec.2, Zhongshan N. Rd., Taipei 10449, Taiwan

TEL: +886 2 2511 3938

### **SANYO DENKI SINGAPORE PTE. LTD.**

988 Toa Payoh North, #04-08, Singapore 319002

TEL: +65 6223 1071

#### **Indonesia Representative Office**

Summitmas II 4th Floor, Jl. Jend. Sudirman Kav.61-62, Jakarta 12190, Indonesia

TEL: + 62 21 252 3202

### **SANYO DENKI GERMANY GmbH**

Frankfurter Strasse 80-82, 65760 Eschborn, Germany

TEL: +49 6196 76113 0

### **SANYO DENKI KOREA CO., LTD.**

15F, KDB Building, 372, Hangang-daero, Yongsan-gu, Seoul, 04323, Korea

TEL: +82 2 773 5623

#### **Busan Branch**

8F, CJ Korea Express Bldg., 119, Daegyo-ro, Jung-gu, Busan, 48943, Korea

TEL: +82 51 796 5151

### **SANYO DENKI (Shenzhen) CO., LTD.**

2F 02-11, Shenzhen International Chamber of Commerce Tower, No.168 Fuhua 3 Road, Futian District, Shenzhen, 518048 China

TEL: +86 755 3337 3868

#### **Tianjin Branch**

Room AB 16th Floor TEDA Building, No. 256 Jie Fang Nan Road, Hexi District, Tianjin 300042 China

TEL: +86 22 2320 1186

#### **Chengdu Branch**

Room2105B, Block A, Times Plaza, 2 Zongfu Road, Jinjiang District, Chengdu, 610016 China

TEL: +86 28 8661 6901

### **SANYO DENKI (THAILAND) CO., LTD.**

388 Exchange Tower, 25th Floor, Unit 2501-1, Sukhumvit Road, Klongtoey, Klongtoey, Bangkok 10110 Thailand

TEL: +66 2261 8670

### **SANYO DENKI INDIA PRIVATE LIMITED**

#14 (Old No.6/3), Avenue Road, Nungambakkam, Chennai - 600034, Tamil Nadu, India

TEL: +91 44 420 384 72