

Airflow Tester

Features (Patented as a movable measurement device for measuring device airflow and system impedance)

Enables the selection of the optimal fan for a device

An optimal fan for a device can be selected by entering accurate measurement results into thermal design simulation software.

Compact and lightweight

With a compact design and weight of approximately 6 kg, it is portable enough to measure immobile equipment.

Measurement Functions

- System Impedance Measurement of the resistance to the flow of air within a device
- Operating Airflow Measurement of the actual airflow that passes through a device when a fan is mounted
- P-Q Performance Measurement of airflow versus static pressure characteristics*

* Performance curve that illustrates the characteristics of a fan for use within a certain system.

It shows the relationship between airflow and static pressure.



With connection duct mounted



Specifications

Model no.		9AT2560S-000□ ⁽¹⁾	9AT2560A-000□ ⁽¹⁾	9AT2560C-000□ ⁽¹⁾
Measurement units	Airflow	m ³ /min	CFM	CFM
	Static pressure	Pa	inchH ₂ O	Pa
Measurement range	Airflow	0.20 to 8.00 m ³ /min (Resolution: 0.01 m ³ /min)	7 to 282 CFM (Resolution: 1 CFM)	7 to 282 CFM (Resolution: 1 CFM)
	Static pressure	0 to 999 Pa (Resolution: 1 Pa)	0 to 4.01 inchH ₂ O (Resolution: 0.01 inchH ₂ O)	0 to 999 Pa (Resolution: 1 Pa)
Measurement accuracy	Airflow	±7% of maximum measurable airflow with each nozzle		
	Static pressure	±10 Pa (0.04 inchH ₂ O) for measurement results < 200 Pa, ±50 Pa (0.20 inchH ₂ O) for measurement results ≥ 200 Pa		
Operating environment	Ambient temperature	0 to 40°C		
	Humidity	20 to 85% RH (non-condensing)		
Display		Data no., Measurement values (airflow, static pressure ⁽²⁾), Measurement status, Nozzle selection, Measurement mode selection		
Interface		Digital output: Included USB serial adapter		
Power supply	Input voltage	100 to 240 VAC, 50/60 Hz		
	Power consumption	260 VA max.		
Dimensions		600 (W) × 250 (H) × 250 (D) mm		
Mass		Main unit: Approx. 6 kg, Connection duct (including board holder): Approx. 1.5 kg		
Included peripherals		1 Set of measurement nozzles, Plastic mounting board (5 pcs / set), Connection duct, AC power cable (2.5 m), USB serial adapter, Instruction manual, Quick start guide, Data viewer software		

(1) The AC power plug shape differs with the number in □ of model numbers.

AC power plug included in models with 1 in □ is for Japan and North America regions (2 parallel flat pins + a round grounding pin), Input voltage: 100/120 VAC, 50/60 Hz

AC power plug included in models with 2 in □ is for Europe region (2 round pins + a female grounding contact), Input voltage: 220 VAC, 50 Hz

AC power plug included in models with 3 in □ is for China region (2 angled flat pins + a flat grounding pin), Input voltage: 220 VAC, 50 Hz

Product also available without an AC power cable. Model no. 9AT2560S-0000, 9AT2560A-0000, 9AT2560C-0000

(2) Static pressure values are calculated with standard atmosphere as 1013 hPa at 20°C.

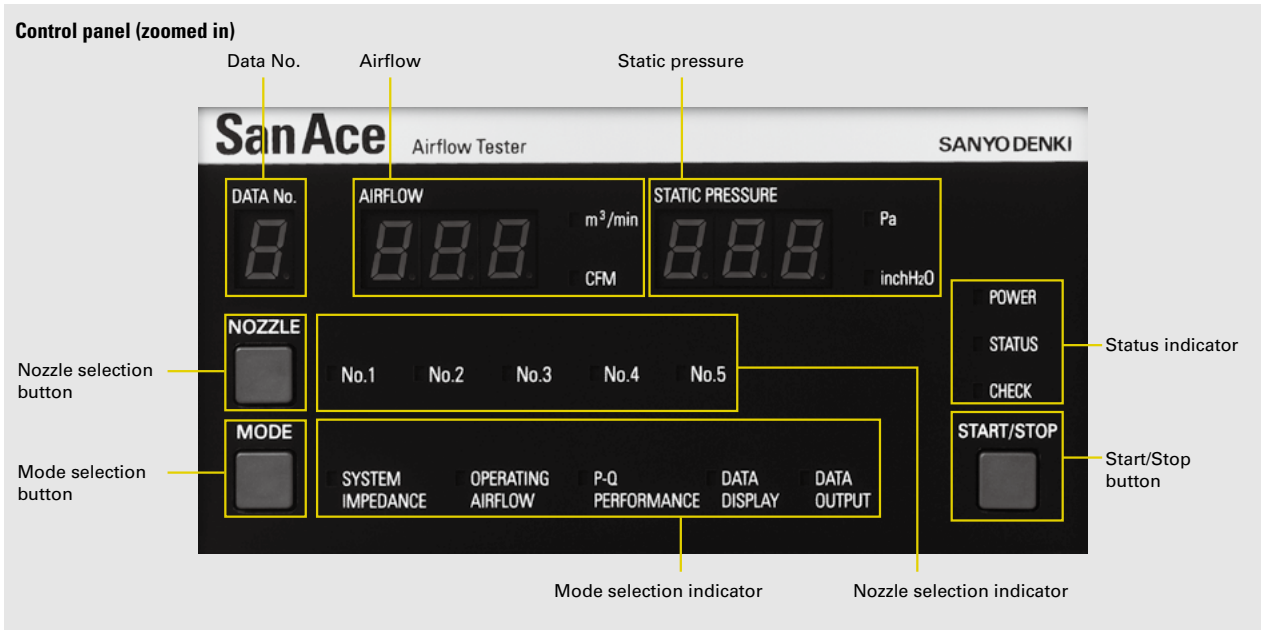
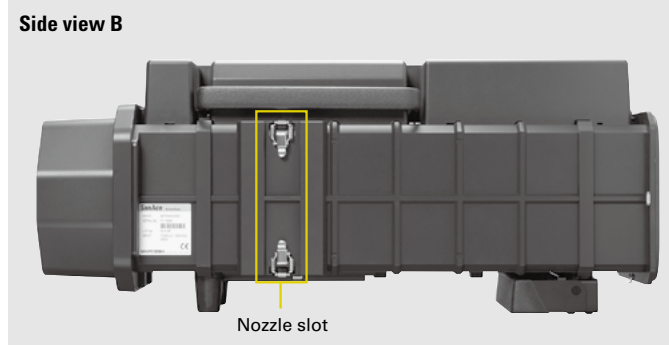
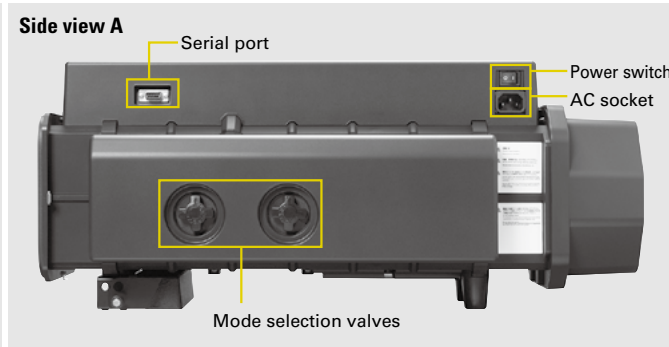
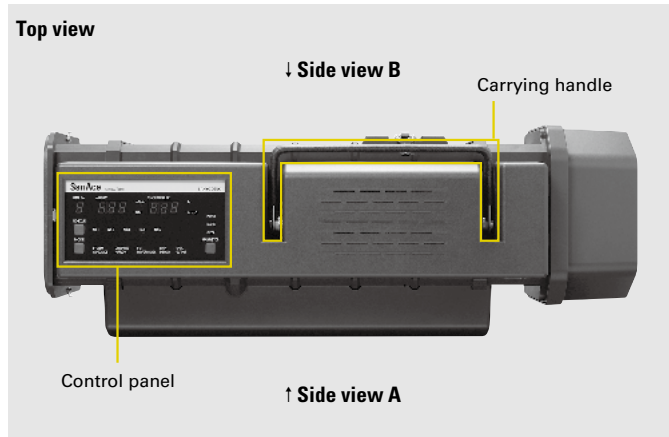

Usage Examples

Cut out a hole in the mounting board matching the vent opening of the device to be measured, and place the mounting board firmly against the device to perform measurements.

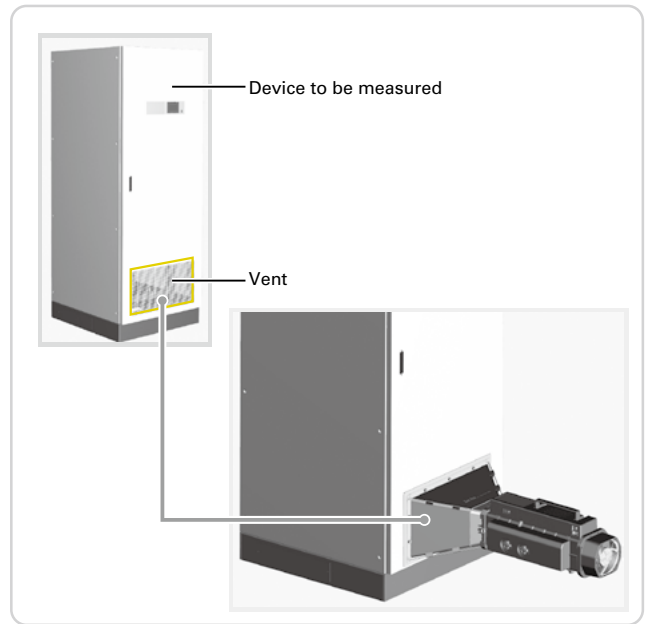
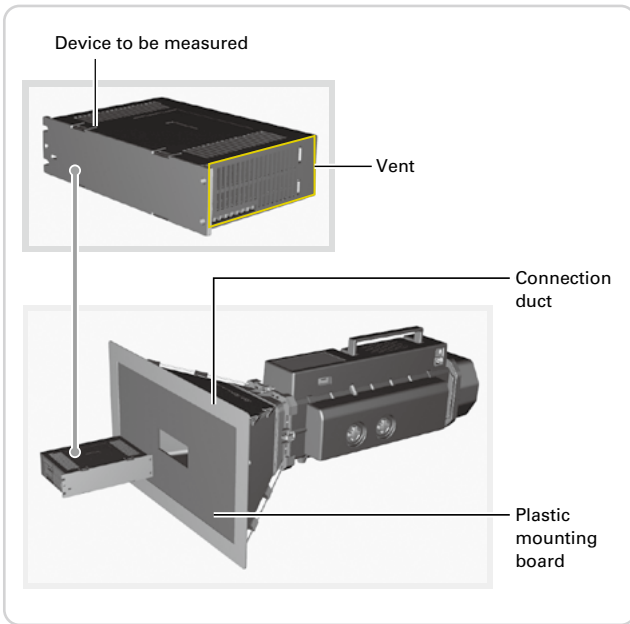

Data Viewer Software (included)

Obtained measurement data can be represented as a graph and saved on a PC.

Screen examples P-Q performance shown below based on catalog data.

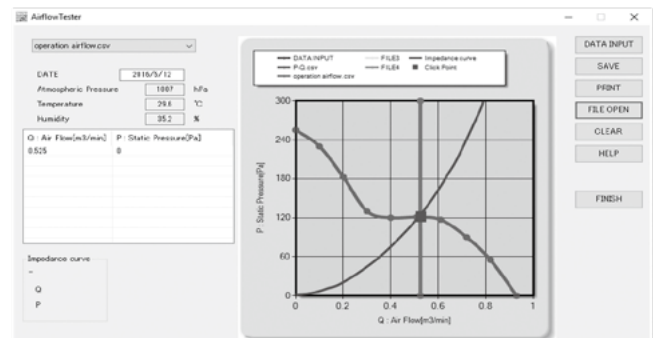
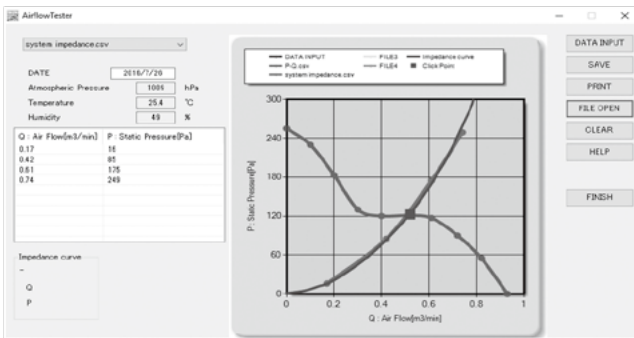

Option

Carrying case Measurement nozzle case included

Model no.	9AT2560-B001 Please add "CS" to the end of the model no. of Airflow Tester in page 1 when ordering Airflow Tester and carrying case as a set. e.g. 9AT2560S-0001CS
Dimensions	705 (W) × 385 (H) × 415 (D) mm



Carrying case, measurement nozzle case

Plastic mounting boards

Sized to fit the duct frame. Five boards included with Airflow Tester.

Model no.	9AT2560-P001
Quantity	5 pcs / set
Dimensions	525 (W) × 275 (H) × 4 (D) mm

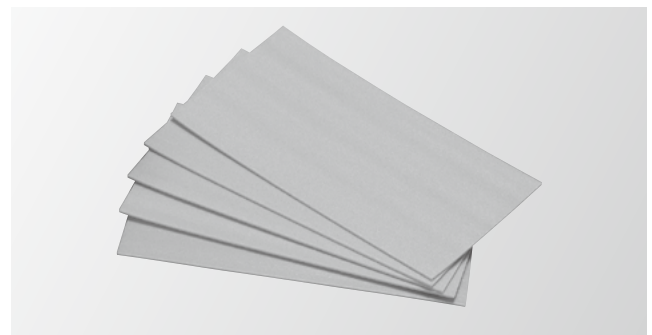

Plastic mounting boards (5 pcs)

■ Dimensions (unit: mm)

● Main unit

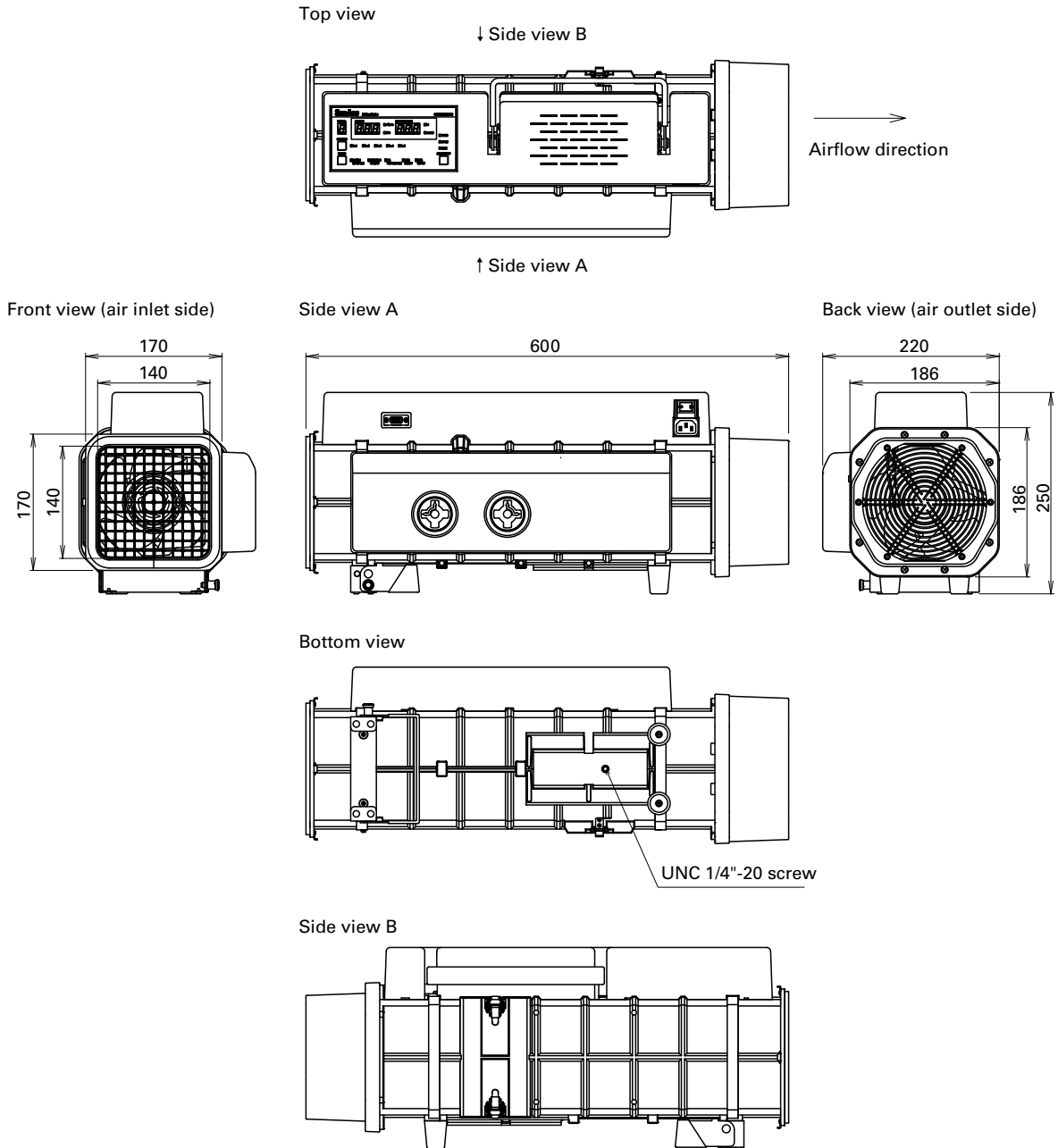

● Connection duct

