

97x33 mm

San Ace B97 9BM type   



General Specifications

- Material Frame: Plastic (Flammability: UL 94V-0), Impeller: Plastic (Flammability: UL 94V-0)
- Expected life See the table below. (L10 life: 90% survival rate for continuous operation in free air at 60°C, rated voltage) Expected life at 40°C is for reference only.
- Motor protection function Locked rotor burnout protection, Reverse polarity protection For details, please refer to p. 580.
- Dielectric strength 50/60 Hz, 500 VAC, for 1 minute (between lead wire conductors and frame)
- Insulation resistance 10 MΩ min. at 500 VDC (between lead wire conductors and frame)
- Sound pressure level (SPL) A-weighted sound pressure level (SPL) at 1 m away from the air inlet.
- Storage temperature -30 to +70°C (Non-condensing)
- Lead wire ⊕Red ⊖Black Sensor Yellow
- Mass 175 g

Specifications

The models listed below **have pulse sensors.**

Model no.	Rated voltage [V]	Operating voltage range [V]	Rated current [A]	Rated input [W]	Rated speed [min ⁻¹]	Max. airflow [m ³ /min] [CFM]	Max. static pressure [Pa] [inchH ₂ O]	SPL [dB (A)]	Operating temperature [°C]	Expected life [h]
109BM12GC2-1	12	7 to 13.8	0.6	7.2	3800	0.82 28.9	281 1.129	51.5	-20 to +70	40000/60°C (70000/40°C)
109BM12HC2-1			0.4	4.8	3300	0.71 25.1	204 0.819	48.5		
109BM12MC2-1			0.26	3.12	2700	0.58 20.5	119 0.478	43.5		
109BM24GC2-1	24	12 to 27.6	0.31	7.44	3800	0.82 28.9	281 1.129	51.5		
109BM24HC2-1			0.26	6.24	3300	0.71 25.1	204 0.819	48.5		
109BM24MC2-1			0.15	3.6	2700	0.58 20.5	119 0.478	43.5		

Note: Sensor and control options are available for selection. Refer to the table on p. 602.

Airflow - Static Pressure Characteristics

109BM12GC2-1 With pulse sensor

Operating voltage range

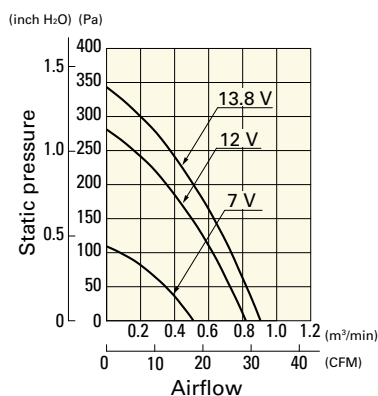

109BM12HC2-1 With pulse sensor

Operating voltage range

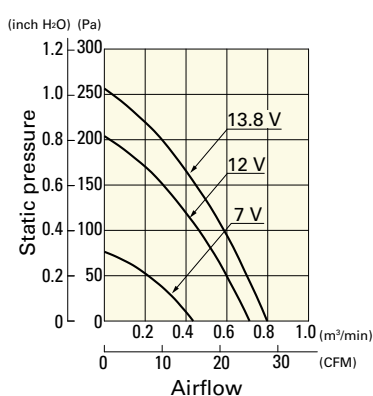

109BM12MC2-1 With pulse sensor

Operating voltage range

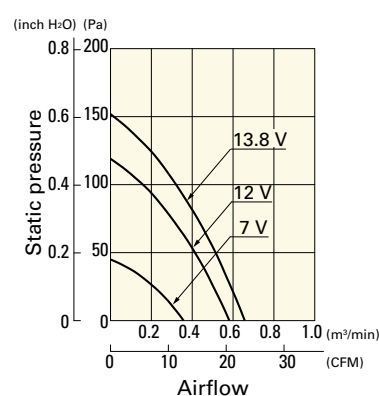

Airflow - Static Pressure Characteristics

109BM24GC2-1 With pulse sensor

Operating voltage range

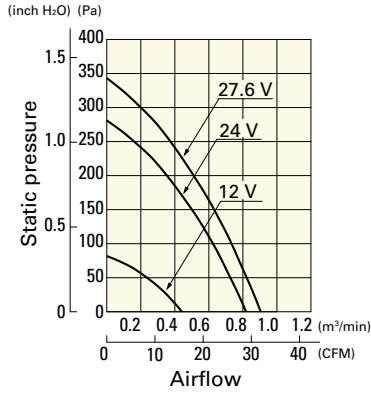

109BM24HC2-1 With pulse sensor

Operating voltage range

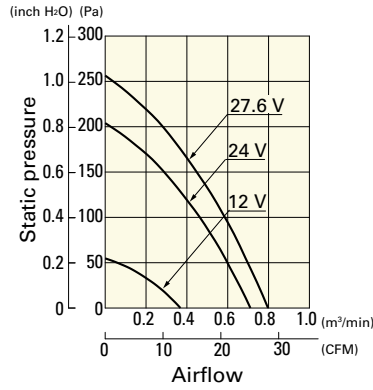

109BM24MC2-1 With pulse sensor

Operating voltage range

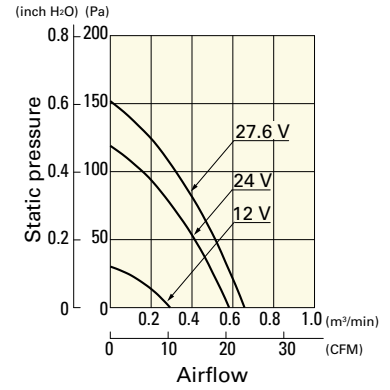

Dimensions (unit: mm)

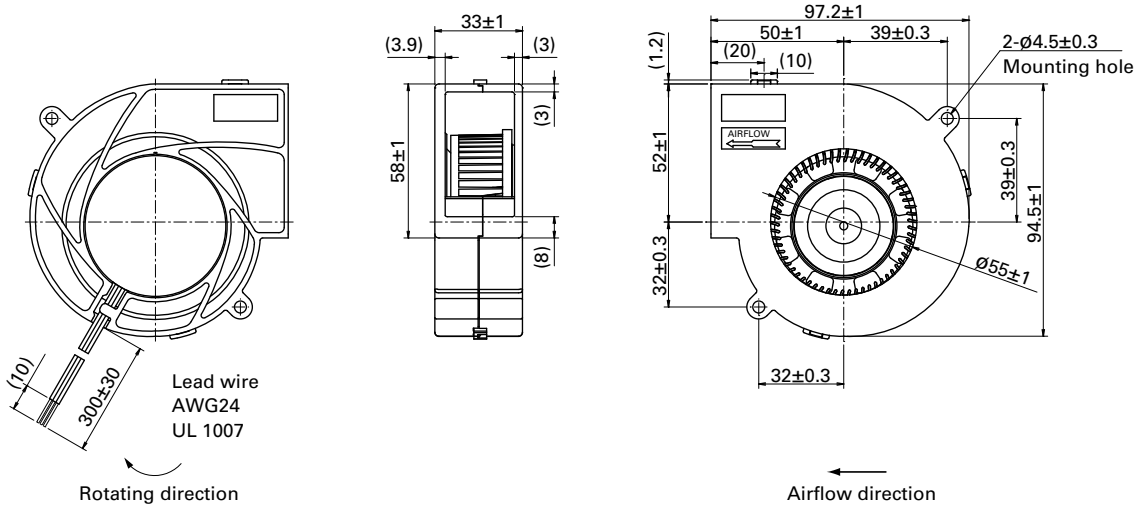

Blower 97 mm DC