



80x80x25 mm

San Ace 80W 9WL type   

DC
Splash Proof Fan 80 mm sq.

General Specifications

- Material Frame: Aluminum (Black coating), Impeller: Plastic (Flammability: UL 94V-1)
- Expected life See the table below. (L10 life: 90% survival rate for continuous operation in indoor free air at 60°C, rated voltage)
Expected life at 40°C is for reference only.
- Motor protection function Locked rotor burnout protection, Reverse polarity protection
For details, please refer to p. 580.
- Dielectric strength 50/60 Hz, 500 VAC, for 1 minute (between lead wire conductors and frame)
- Insulation resistance 10 MΩ min. at 500 VDC (between lead wire conductors and frame)
- Sound pressure level (SPL) A-weighted sound pressure level (SPL) at 1 m away from the air inlet.
- Storage temperature -30 to +70°C (Non-condensing)
- Lead wire ⊕Red ⊖Black Sensor Yellow Control Brown
(For models without PWM control function, there is no speed control wiring.)
- Mass 150 g
- Ingress protection IP68

Specifications

The models listed below **have pulse sensors with PWM control function.**

Model no.	Rated voltage [V]	Operating voltage range [V]	PWM duty cycle* [%]	Rated current [A]	Rated input [W]	Rated speed [min ⁻¹]	Max. airflow [m ³ /min] [CFM]		Max. static pressure [Pa] [inchH ₂ O]		SPL [dB (A)]	Operating temperature [°C]	Expected life [h]
9WL0812P4J001	12	10.8 to 13.2	100	0.6	7.2	7400	2.07	73.0	177	0.71	49	-20 to +70	180000/60°C (215000/40°C)
			20	0.06	0.72	1800	0.5	17.6	10.4	0.04	16		
9WL0812P4G001			100	0.3	3.6	5500	1.54	54.3	98	0.39	43		
			25	0.05	0.6	1400	0.39	13.7	6.3	0.02	14		
9WL0812P4H001			100	0.12	1.44	3700	1.03	36.3	44	0.17	31		
			25	0.04	0.48	1100	0.3	10.5	3.9	0.01	13		
9WL0824P4J001	24	21.6 to 26.4	100	0.28	6.72	7400	2.07	73.0	177	0.71	49		
			20	0.05	1.2	2400	0.67	23.6	18.6	0.07	22		
9WL0824P4G001			100	0.14	3.36	5500	1.54	54.3	98	0.39	43		
			20	0.02	0.48	1200	0.33	11.6	4.6	0.01	13		
9WL0824P4H001			100	0.05	1.2	3700	1.03	36.3	44	0.17	31		
			30	0.02	0.48	1100	0.3	10.5	3.9	0.01	13		

* PWM frequency is 25 kHz. Models without ratings for 0% PWM duty cycle have zero speed at 0%. When control terminal is open, speed is the same as at 100% duty cycle.

The models listed below **have pulse sensors.**

Model no.	Rated voltage [V]	Operating voltage range [V]	Rated current [A]	Rated input [W]	Rated speed [min ⁻¹]	Max. airflow [m ³ /min] [CFM]		Max. static pressure [Pa] [inchH ₂ O]		SPL [dB (A)]	Operating temperature [°C]	Expected life [h]
9WL0812L4001	12	8 to 13.2	0.06	0.72	2300	0.64	22.6	17	0.068	22	-20 to +70	180000/60°C (215000/40°C)
9WL0824F4001	24	12 to 26.4	0.045	1.08	3300	0.92	32.5	35	0.14	29		
9WL0824L4001		14 to 26.4	0.03	0.72	2300	0.64	22.6	17	0.068	22		

Note: Sensor and control options are available for selection. Refer to the table on pp. 618 to 619.

Airflow - Static Pressure Characteristics / PWM Duty - Speed Characteristics Example

9WL0812P4J001 With pulse sensor with PWM control function

PWM duty cycle

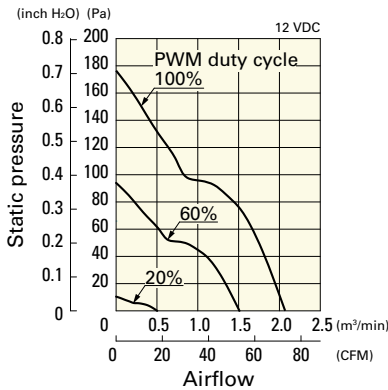

Operating voltage range

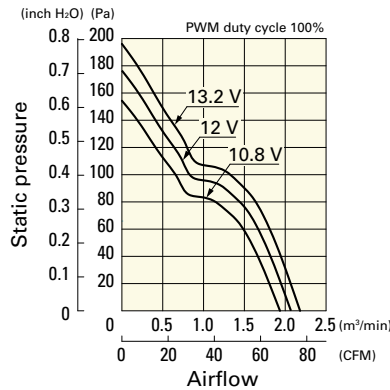

PWM duty - Speed characteristics example

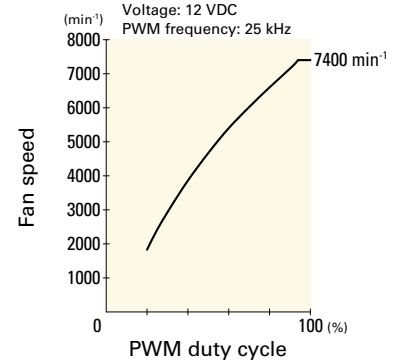

9WL0812P4G001 With pulse sensor with PWM control function

PWM duty cycle

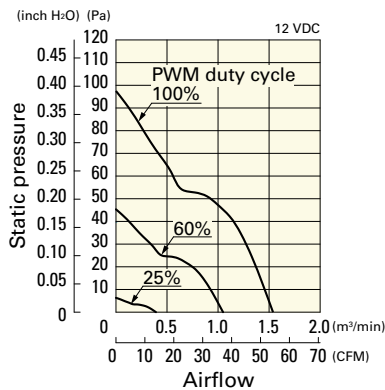

Operating voltage range

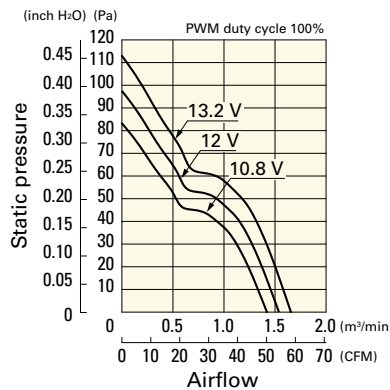

PWM duty - Speed characteristics example

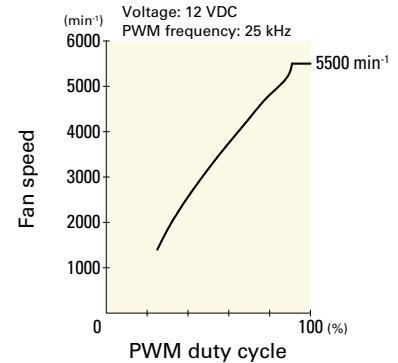

9WL0812P4H001 With pulse sensor with PWM control function

PWM duty cycle

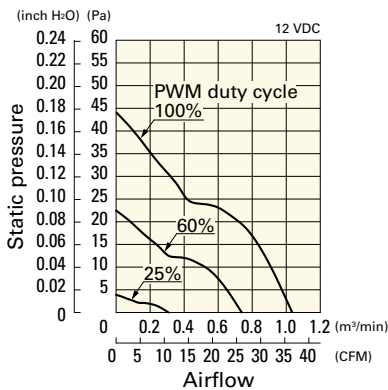

Operating voltage range

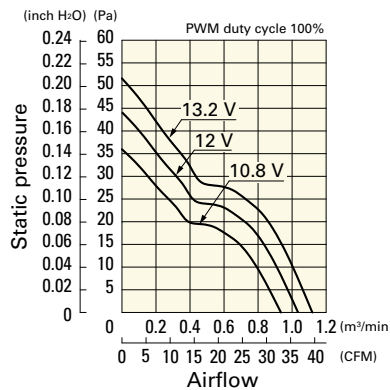

PWM duty - Speed characteristics example

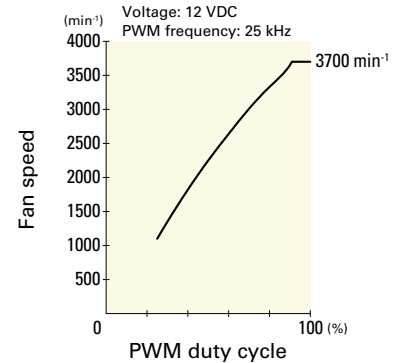

9WL0824P4J001 With pulse sensor with PWM control function

PWM duty cycle

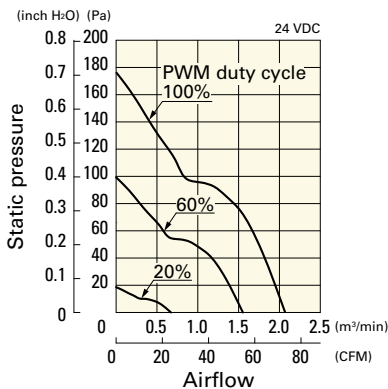

Operating voltage range

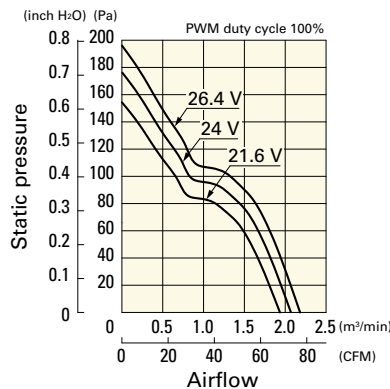

PWM duty - Speed characteristics example

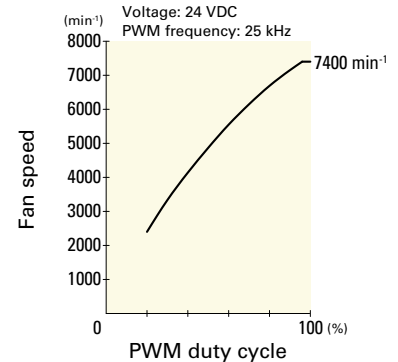

DC
Splash Proof Fan 80 mm sq.

Airflow - Static Pressure Characteristics / PWM Duty - Speed Characteristics Example

9WL0824P4G001 With pulse sensor with PWM control function

PWM duty cycle

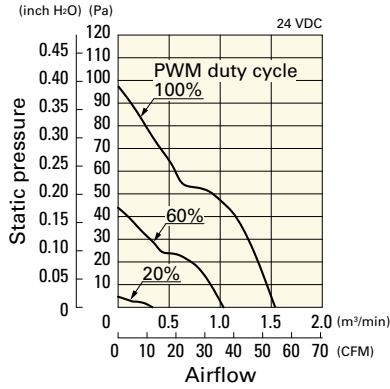

Operating voltage range

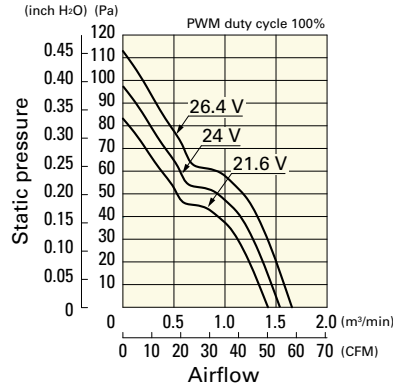

PWM duty - Speed characteristics example

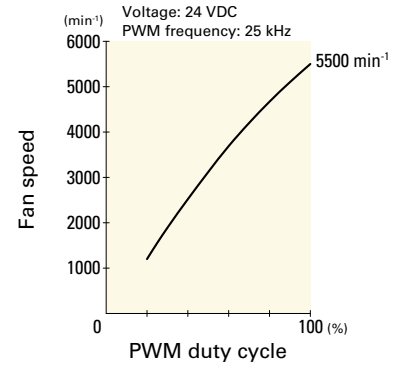

9WL0824P4H001 With pulse sensor with PWM control function

PWM duty cycle

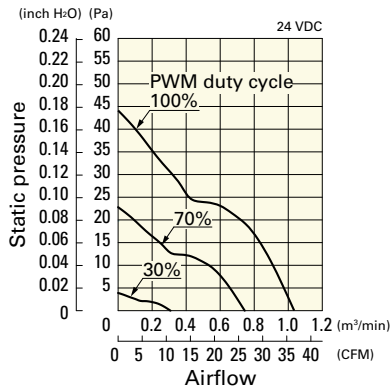

Operating voltage range

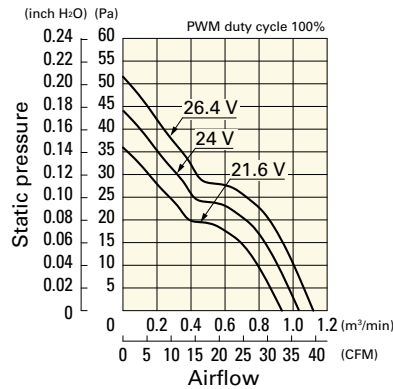

PWM duty - Speed characteristics example

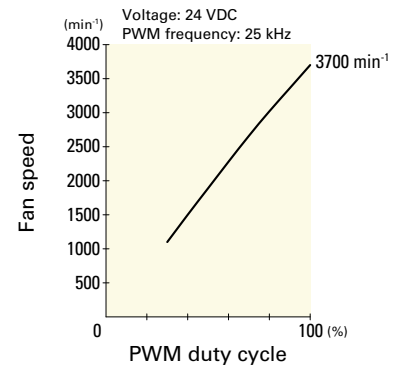

Airflow - Static Pressure Characteristics

9WL0812L4001 With pulse sensor

Operating voltage range

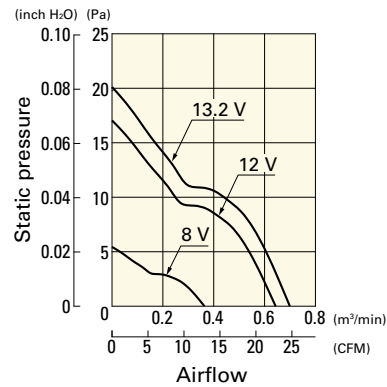

9WL0824F4001 With pulse sensor

Operating voltage range

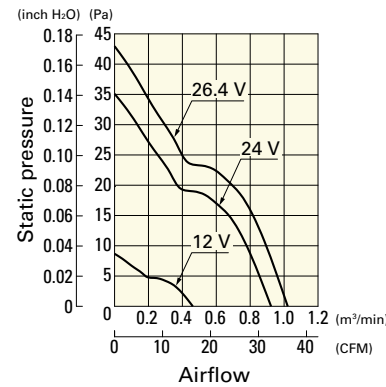

9WL0824L4001 With pulse sensor

Operating voltage range

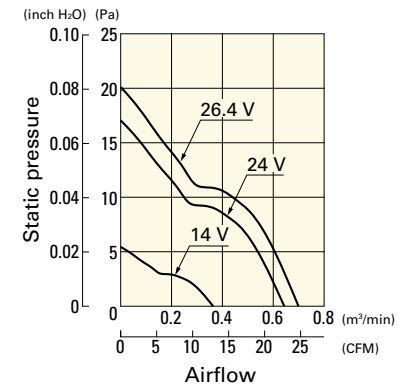

Dimensions (unit: mm) (With pulse sensor with PWM control function)

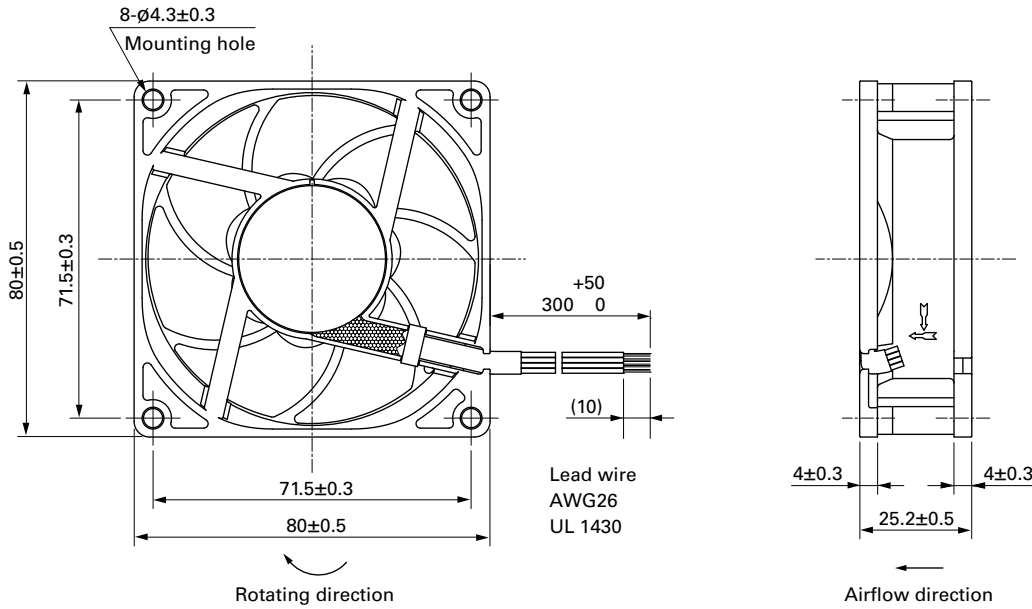

Reference Dimensions of Mounting Holes and Vent Opening (unit: mm)

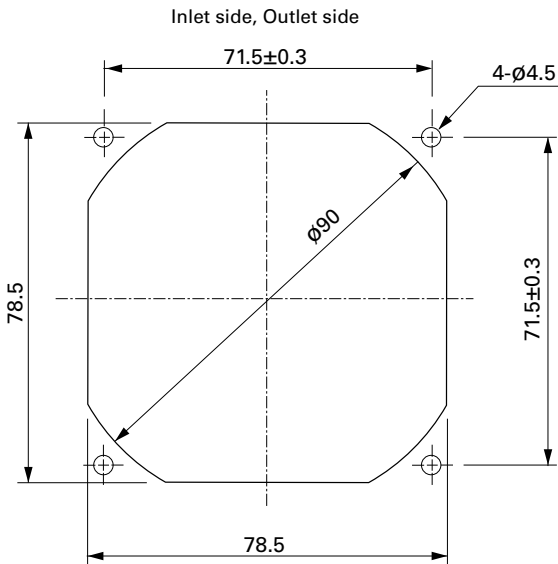

Options

Finger guards

page: p. 564

Model no.: 109-049E, 109-049H, 109-049C

Resin finger guards

page: p. 571

Model no.: 109-1002G