

DC Fan



80×80×25 mm

San Ace 80 9RA type

General Specifications

- Material Frame: Plastic (Flammability: UL 94V-0), Impeller: Plastic (Flammability: UL 94V-1)
- Expected life See the table below. (L10 life: 90% survival rate for continuous operation in free air at 60°C, rated voltage)
Expected life at 40°C is for reference only.
- Motor protection function Locked rotor burnout protection, Reverse polarity protection
For details, please refer to p. 580.
- Dielectric strength 50/60 Hz, 500 VAC, for 1 minute (between lead wire conductors and frame)
- Insulation resistance 10 MΩ min. at 500 VDC (between lead wire conductors and frame)
- Sound pressure level (SPL) A-weighted sound pressure level (SPL) at 1 m away from the air inlet.
- Storage temperature -30 to +70°C (Non-condensing)
- Lead wire ⊕Red ⊖Black Sensor Yellow Control Brown
(For models without PWM control function, there is no speed control wiring.)
- Mass 110 g

Specifications

The models listed below **have ribs and pulse sensors with PWM control function.** For models without ribs, append "1" to the end of model numbers.

Model no.	Rated voltage [V]	Operating voltage range [V]	PWM duty cycle [%]	Rated current [A]	Rated input [W]	Rated speed [min ⁻¹]	Max. airflow [m ³ /min] [CFM]	Max. static pressure [Pa] [inchH ₂ O]	SPL [dB (A)]	Operating temperature [°C]	Expected life [h]
» 9RA0812P4G001	12	10.8 to 13.2	100	0.22	2.64	5000	1.4 49.4	83 0.33	37	-20 to +70	60000/60°C (90000/40°C)
			30	0.03	0.36	1100	0.3 10.6	4 0.01	11		
» 9RA0824P4G001	24	21.6 to 26.4	100	0.11	2.64	5000	1.4 49.4	83 0.33	37		
			20	0.02	0.48	1000	0.28 9.8	3.3 0.01	10		
» 9RA0848P4G001	48	43.2 to 52.8	100	0.07	3.36	5000	1.4 49.4	83 0.33	37		
			20	0.02	0.96	1700	0.47 16.5	9.6 0.04	14		

* PWM frequency is 25 kHz. Models without ratings for 0% PWM duty cycle have zero speed at 0%. When control terminal is open, speed is the same as at 100% duty cycle.

The models listed below **have ribs and pulse sensors.** For models without ribs, append "1" to the end of model numbers.

Model no.	Rated voltage [V]	Operating voltage range [V]	Rated current [A]	Rated input [W]	Rated speed [min ⁻¹]	Max. airflow [m ³ /min] [CFM]	Max. static pressure [Pa] [inchH ₂ O]	SPL [dB (A)]	Operating temperature [°C]	Expected life [h]
» 9RA0812G4001	12	7 to 13.8	0.22	2.64	5000	1.4 49.4	83 0.33	37	-20 to +70	60,000/60°C (90,000/40°C)
» 9RA0812S4001			0.12	1.44	3900	1.09 38.5	50 0.21	31		
» 9RA0812H4001			0.08	0.96	3300	0.92 32.5	36 0.14	27		
» 9RA0812M4001			0.06	0.72	2650	0.74 26.1	23 0.09	22		
» 9RA0824G4001	24	14 to 27.6	0.11	2.64	5000	1.4 49.4	83 0.33	37		
» 9RA0824S4001			0.06	1.44	3900	1.09 38.5	50 0.21	31		
» 9RA0824H4001			0.05	1.2	3300	0.92 32.5	36 0.14	27		
» 9RA0824M4001			0.04	0.96	2650	0.74 26.1	23 0.09	22		
» 9RA0848G4001	48	36 to 55.2	0.07	3.36	5000	1.4 49.4	83 0.33	37		
» 9RA0848S4001			0.05	2.4	3900	1.09 38.5	50 0.21	31		

Note 1: Sensor and control options are available for selection. Refer to the table on pp. 614 to 615.

Note 2: The » mark indicates Short LeadTime Service applicable models. See p. 630 for details.

Airflow - Static Pressure Characteristics / PWM Duty - Speed Characteristics Example

9RA0812P4G001 With pulse sensor with PWM control function

PWM duty cycle

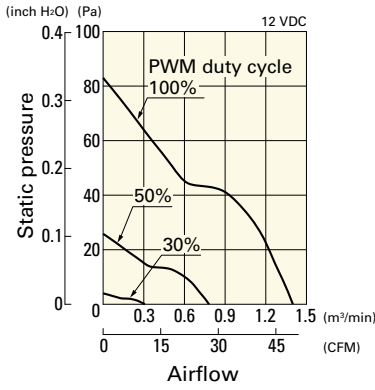

Operating voltage range

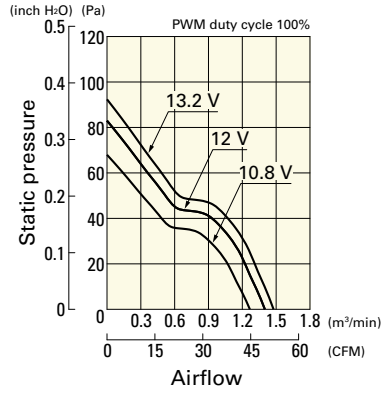

PWM duty - Speed characteristics example

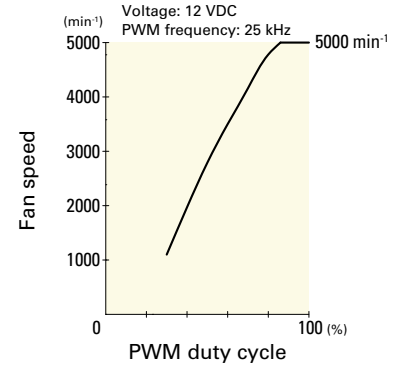

9RA0824P4G001 With pulse sensor with PWM control function

PWM duty cycle

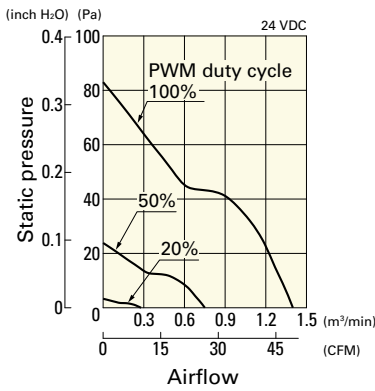

Operating voltage range

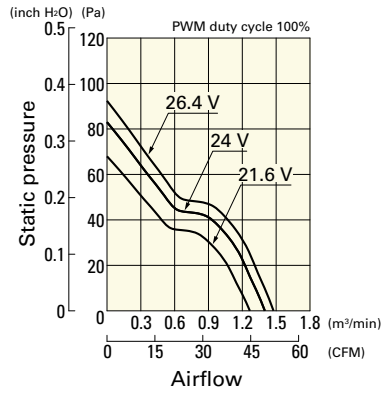

PWM duty - Speed characteristics example

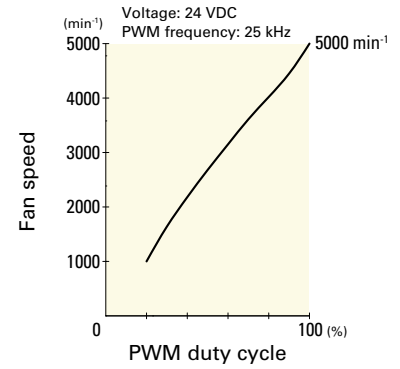

9RA0848P4G001 With pulse sensor with PWM control function

PWM duty cycle

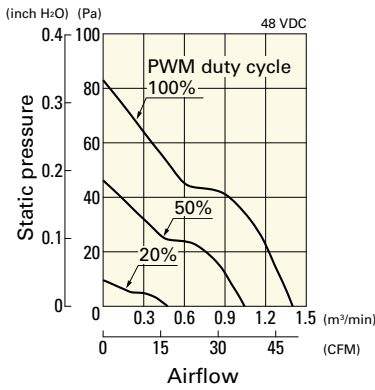

Operating voltage range

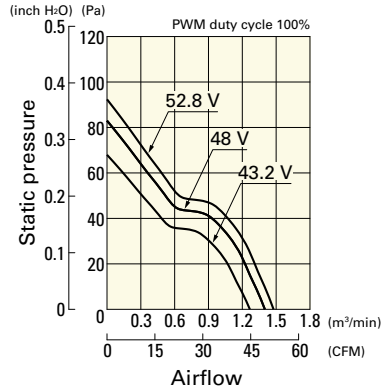

PWM duty - Speed characteristics example

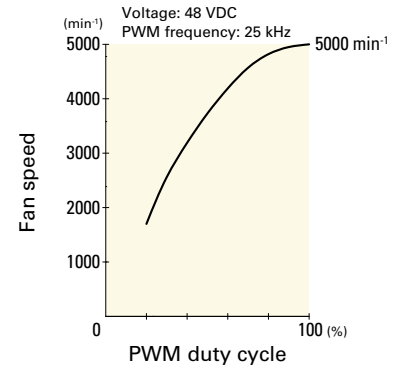

Airflow - Static Pressure Characteristics

9RA0812G4001 With pulse sensor

Operating voltage range

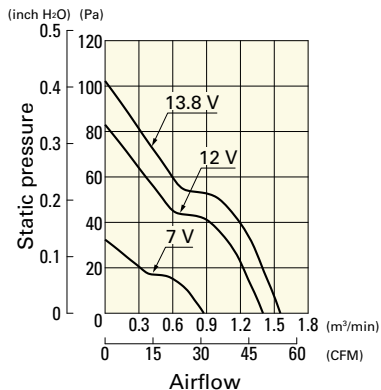

9RA0812S4001 With pulse sensor

Operating voltage range

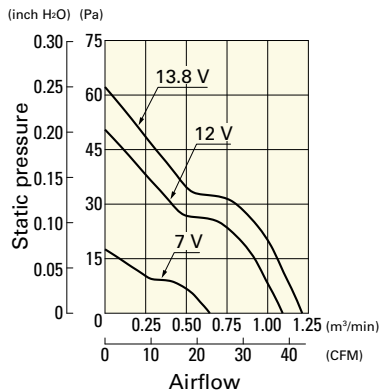

9RA0812H4001 With pulse sensor

Operating voltage range

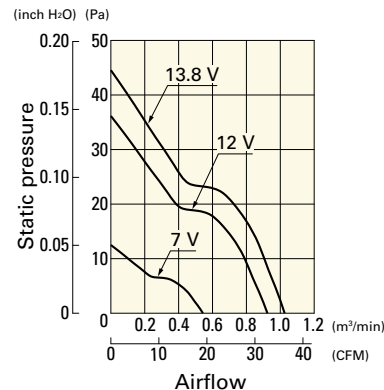

9RA0812M4001 With pulse sensor

Operating voltage range

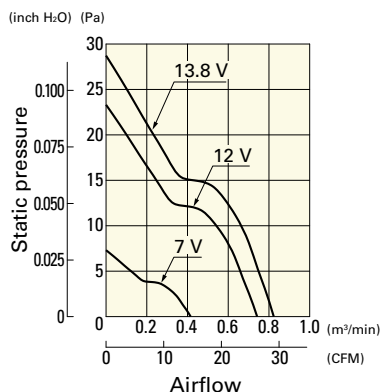

9RA0824G4001 With pulse sensor

Operating voltage range

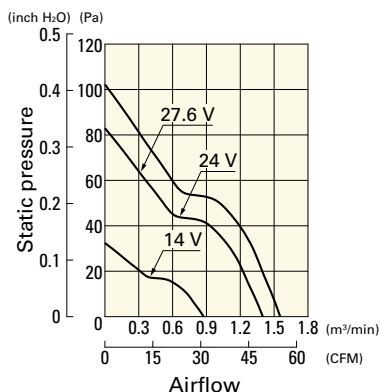

9RA0824S4001 With pulse sensor

Operating voltage range

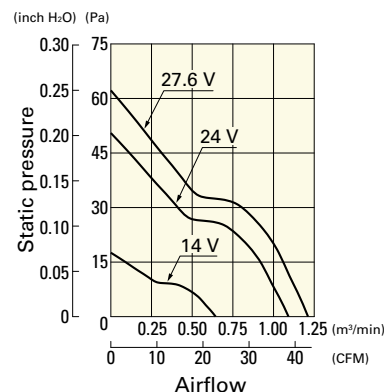

9RA0824H4001 With pulse sensor

Operating voltage range

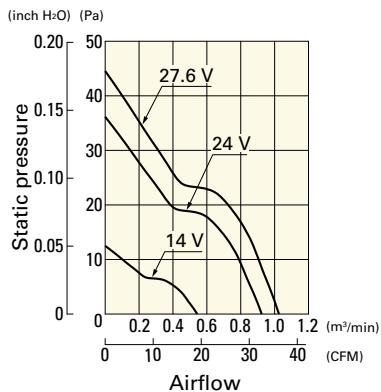

9RA0824M4001 With pulse sensor

Operating voltage range

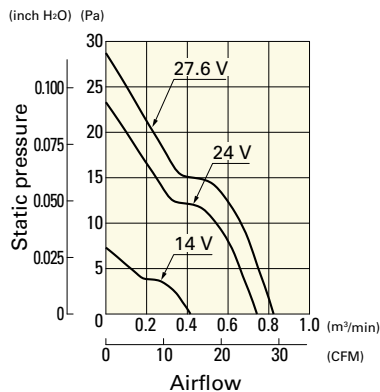

9RA0848G4001 With pulse sensor

Operating voltage range

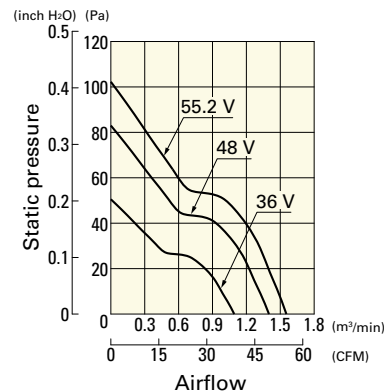

9RA0848S4001 With pulse sensor

Operating voltage range

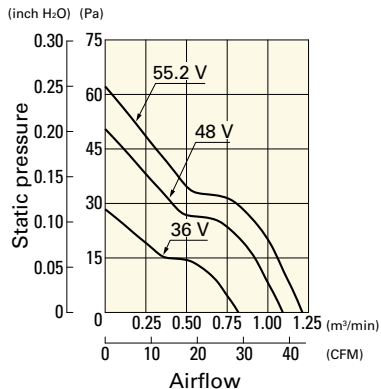

Dimensions (unit: mm) (Ribbed frame with pulse sensor with PWM control function)

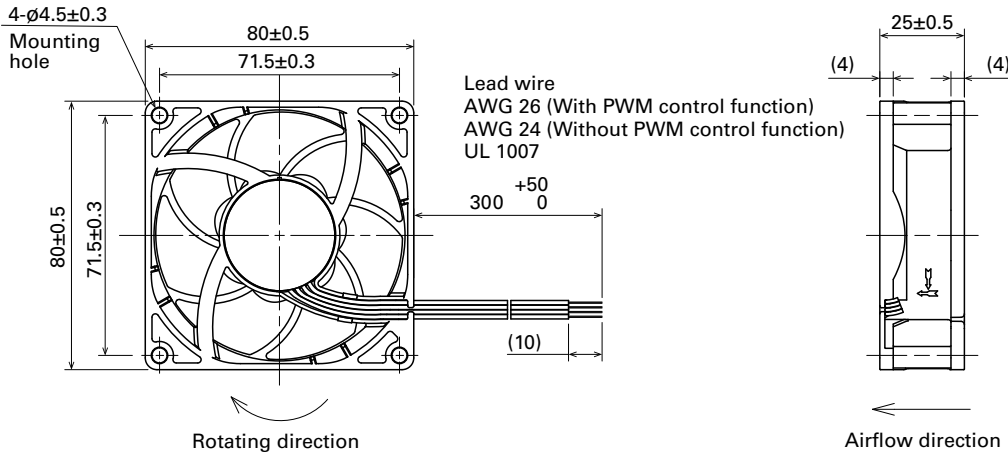

Reference Dimensions of Mounting Holes and Vent Opening (unit: mm)

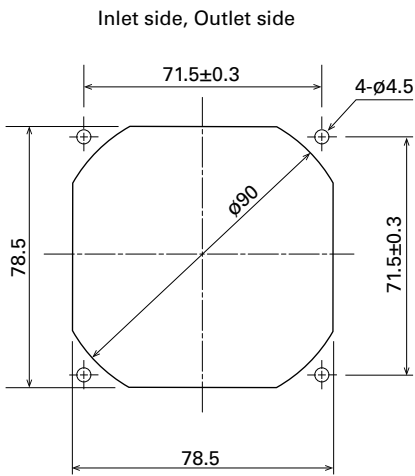

Options

Finger guards

page: p. 564

Model no.: 109-049E, 109-049H, 109-049C

Resin finger guards

page: p. 571

Model no.: 109-1002G

Resin filter kits

page: p. 572

Model no.: 109-1002F13 (13PPI), 109-1002F20 (20PPI),
109-1002F30 (30PPI), 109-1002F40 (40PPI)