

Ø 175x69 mm

San Ace C175 9TG type US

General Specifications

- Material Motor case: Aluminum (Black coating), Impeller: Plastic (Flammability: UL 94V-0)
- Expected life See the table below. (L10 life: 90% survival rate for continuous operation in free air at 60°C, rated voltage) Expected life at 40°C is for reference only.
- Motor protection function Locked rotor burnout protection, Reverse polarity protection For details, please refer to p. 580.
- Dielectric strength 50/60 Hz, 500 VAC, for 1 minute (between lead wire conductors and motor case)
- Insulation resistance 10 MΩ min. at 500 VDC (between lead wire conductors and motor case)
- Sound pressure level (SPL) A-weighted sound pressure level (SPL) at 1 m away from the air inlet.
- Storage temperature -30 to +70°C (Non-condensing)
- Lead wire ⊕Red ⊖Black Sensor Yellow Control Brown
- Mass 750 g

Specifications When the optional inlet nozzle (109-1073) is mounted.

The models listed below **have pulse sensors with PWM control function.**

Model no.	Rated voltage [V]	Operating voltage range [V]	PWM duty cycle [%]	Rated current [A]	Rated input [W]	Rated speed [min ⁻¹]	Max. airflow [m ² /min] [CFM]	Max. static pressure [Pa] [inchH ₂ O]	SPL [dB (A)]	Operating temperature [°C]	Expected life [h]
9TG24P0G01	24	20.4 to 27.6	100	3.9	93.6	4700	14.0 494.7	885 3.55	73	-20 to +60	40000/60°C (70000/40°C)
9TG24P0S01			100	2.35	56.4	3900	11.6 409.8	609 2.45	69		
9TG48P0G01	48	36 to 55.2	100	1.95	93.6	4700	14.0 494.7	885 3.55	73	-20 to +70	

* PWM frequency is 25 kHz. Models without ratings for 0% PWM duty cycle have zero speed at 0%. When control terminal is open, speed is the same as at 100% duty cycle.

Note 1: Max input is 130 W at rated voltage.

Note 2: Sensor and control options are available for selection. Refer to the table on p. 617.

Airflow - Static Pressure Characteristics / PWM Duty - Speed Characteristics Example

9TG24P0G01 With pulse sensor with PWM control function

PWM duty cycle

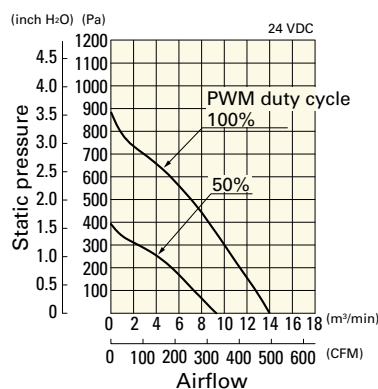

Operating voltage range

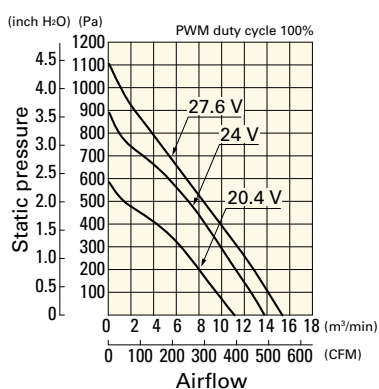

PWM duty - Speed characteristics example

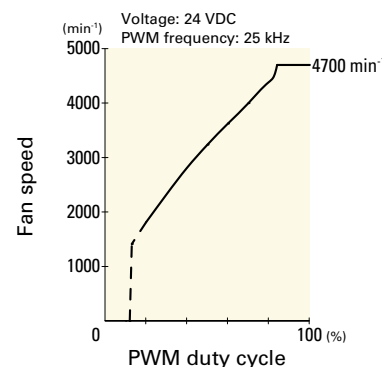

Airflow - Static Pressure Characteristics / PWM Duty - Speed Characteristics Example

9TG24P0S01 With pulse sensor with PWM control function

PWM duty cycle

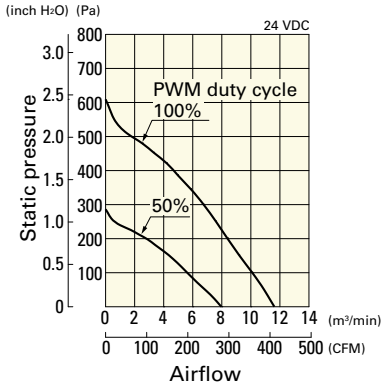

Operating voltage range

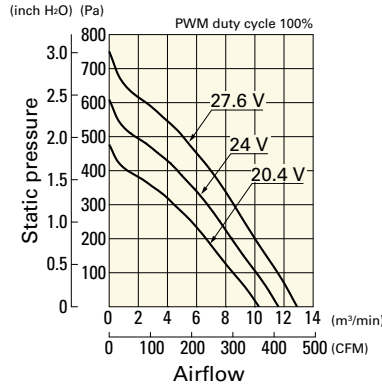

PWM duty - Speed characteristics example

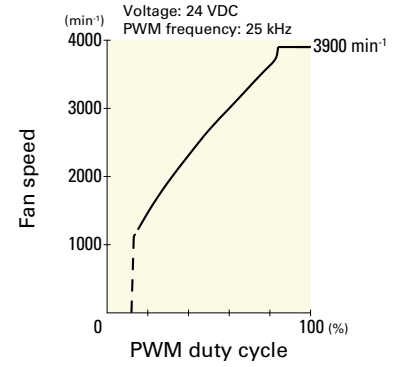

9TG48P0G01 With pulse sensor with PWM control function

PWM duty cycle

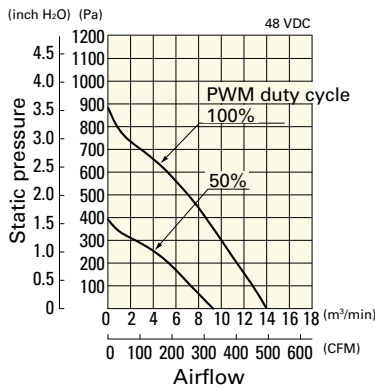

Operating voltage range

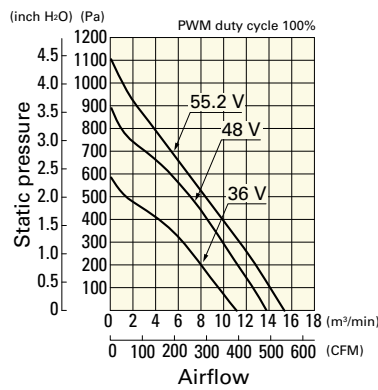

PWM duty - Speed characteristics example

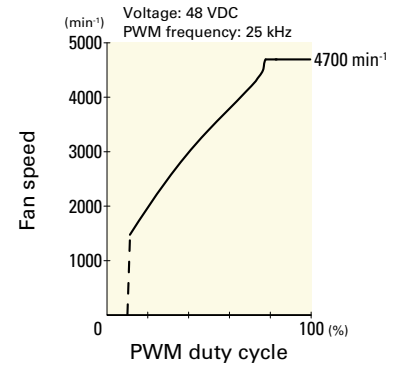

Dimensions (unit: mm)

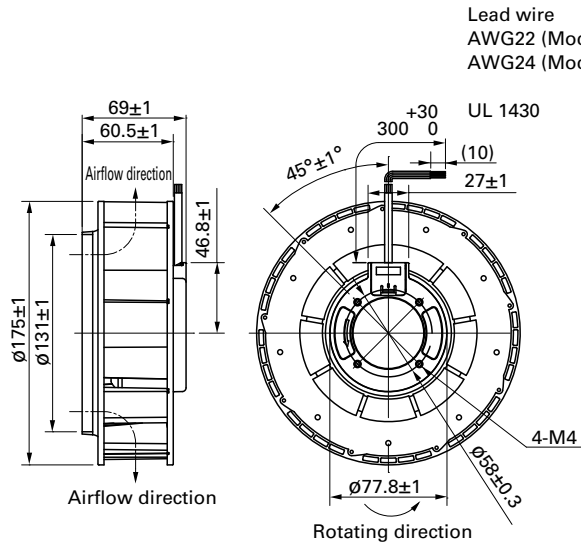

DC
Centrifugal Fan ø175 mm