



# 140x140x38 mm

San Ace 140L 9LG type



DC Long Life Fan 140 mm sq.

## General Specifications

- Material ..... Frame: Aluminum (Black coating), Impeller: Plastic (Flammability: UL 94V-1)
- Expected life ..... See the table below. (L10 life: 90% survival rate for continuous operation in free air at 60°C, rated voltage) Expected life at 40°C is for reference only.
- Motor protection function ..... Locked rotor burnout protection, Reverse polarity protection  
For details, please refer to p. 580.
- Dielectric strength ..... 50/60 Hz, 500 VAC, for 1 minute (between lead wire conductors and frame)
- Insulation resistance ..... 10 MΩ min. at 500 VDC (between lead wire conductors and frame)
- Sound pressure level (SPL) ..... A-weighted sound pressure level (SPL) at 1 m away from the air inlet.
- Storage temperature ..... -30 to +70°C (Non-condensing)
- Lead wire ..... ⊕Red ⊖Black (Sensor) Yellow (Control) Brown  
(For models without PWM control function, there is no speed control wiring.)
- Mass ..... 640 g

## Specifications

The models listed below **have pulse sensors with PWM control function.**

Model no.	Rated voltage [V]	Operating voltage range [V]	PWM duty cycle [%]	Rated current [A]	Rated input [W]	Rated speed [min <sup>-1</sup> ]	Max. airflow [m <sup>3</sup> /min] [CFM]	Max. static pressure [Pa] [inchH <sub>2</sub> O]	SPL [dB (A)]	Operating temperature [°C]	Expected life [h]	
9LG1412P1A001	12	10.2 to 13.8	100	3.72	44.64	6900	8.0 282	516 2.07	68	-20 to +70	180000/60°C (215000/40°C)	
			20	0.27	3.24	2300	2.66 93	80 0.32	39			
9LG1412P1H001			100	1.7	20.4	5200	6.0 212	300 1.2	62			
			20	0.27	3.24	2300	2.66 93	80 0.32	39			
9LG1412P1M001			100	0.6	7.2	3300	3.7 130	170 0.68	46			
			20	0.16	1.92	1300	1.45 51	26 0.1	29			
9LG1424P1A001		24	20.4 to 27.6	100	1.86	44.64	6900	8.0 282	516 2.07			68
				20	0.17	4.08	2300	2.66 93	80 0.32			39
9LG1424P1H001				100	0.85	20.4	5200	6.0 212	300 1.2			62
				20	0.16	3.84	2300	2.66 93	80 0.32			39
9LG1424P1M001				100	0.3	7.2	3300	3.7 130	170 0.68			46
				20	0.11	2.64	1300	1.45 51	26 0.1			29
9LG1448P1A001	48	40.8 to 55.2	100	0.92	44.16	6900	8.0 282	516 2.07	68			
			20	0.11	5.28	2300	2.66 93	80 0.32	39			
9LG1448P1H001			100	0.42	20.16	5200	6.0 212	300 1.2	62			
			20	0.11	5.28	2300	2.66 93	80 0.32	39			
9LG1448P1M001			100	0.15	7.2	3300	3.7 130	170 0.68	46			
			20	0.09	4.32	1300	1.45 51	26 0.1	29			

\* PWM frequency is 25 kHz. Models without ratings for 0% PWM duty cycle have zero speed at 0%. When control terminal is open, speed is the same as at 100% duty cycle.

The models listed below **have pulse sensors.**

Model no.	Rated voltage [V]	Operating voltage range [V]	Rated current [A]	Rated input [W]	Rated speed [min <sup>-1</sup> ]	Max. airflow [m <sup>3</sup> /min] [CFM]	Max. static pressure [Pa] [inchH <sub>2</sub> O]	SPL [dB (A)]	Operating temperature [°C]	Expected life [h]
9LG1412L1001	12	10.2 to 13.8	0.27	3.3	2300	2.6 91.9	80 0.32	39	-20 to +70	180000/60°C (215000/40°C)
9LG1424L1001	24	20.4 to 27.6	0.17	4.1	2300	2.6 91.9	80 0.32	39		
9LG1448L1001	48	40.8 to 55.2	0.11	5.3	2300	2.6 91.9	80 0.32	39		

Note 1: Sensor and control options are available for selection. Refer to the table on p. 614.

Note 2: The mark indicates Short Lead Time Service applicable models. See p. 630 for details.

# Airflow - Static Pressure Characteristics / PWM Duty - Speed Characteristics Example

**9LG1412P1A001** With pulse sensor with PWM control function

PWM duty cycle

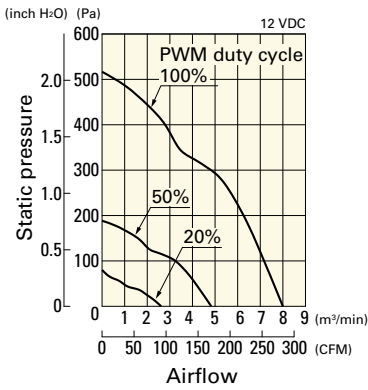

Operating voltage range

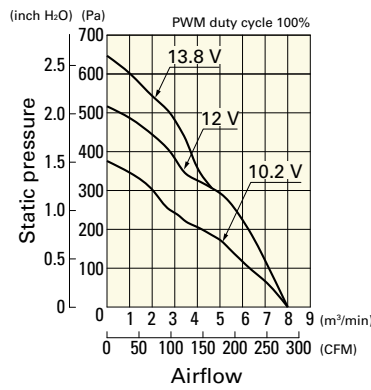

PWM duty - Speed characteristics example

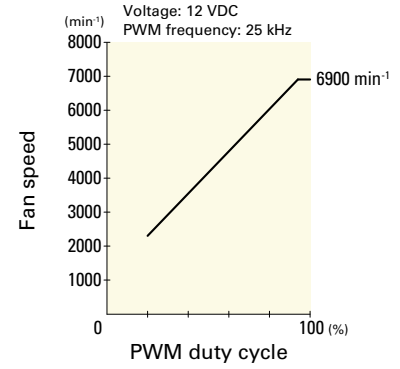

**9LG1412P1H001** With pulse sensor with PWM control function

PWM duty cycle

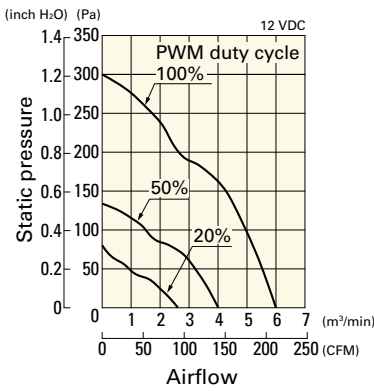

Operating voltage range

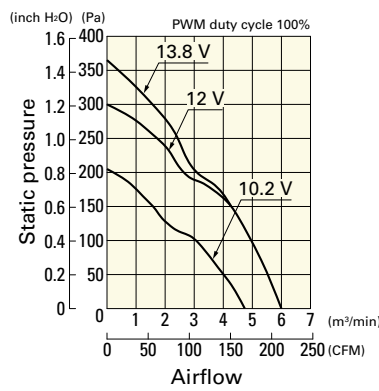

PWM duty - Speed characteristics example

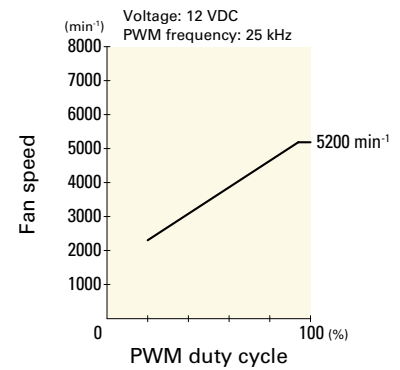

**9LG1412P1M001** With pulse sensor with PWM control function

PWM duty cycle

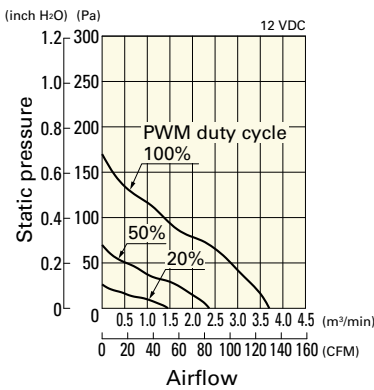

Operating voltage range

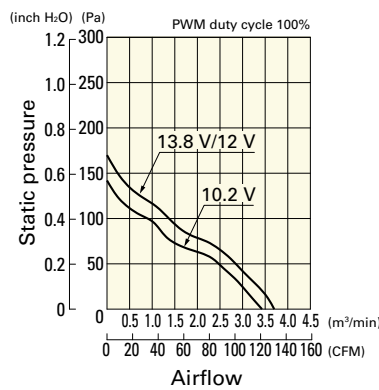

PWM duty - Speed characteristics example

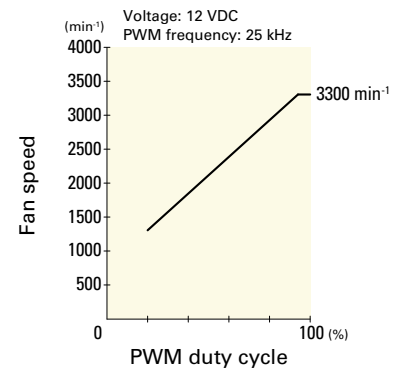

**9LG1424P1A001** With pulse sensor with PWM control function

PWM duty cycle

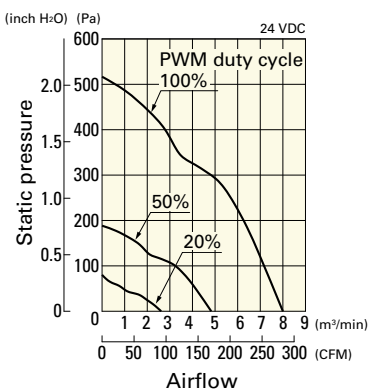

Operating voltage range

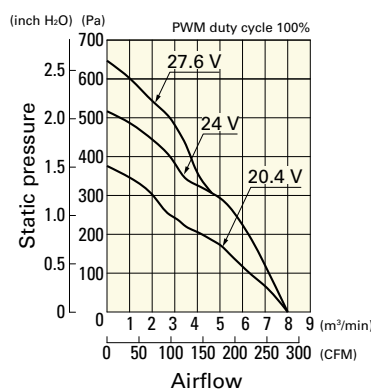

PWM duty - Speed characteristics example

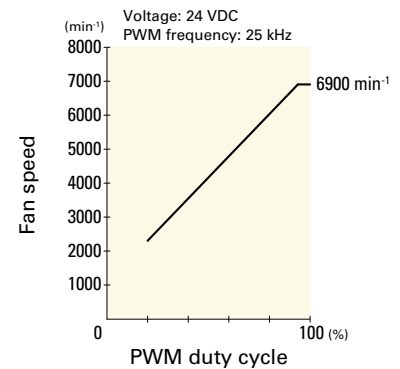

DC  
Long Life Fan 140 mm sq.

# Airflow - Static Pressure Characteristics / PWM Duty - Speed Characteristics Example

**9LG1424P1H001** With pulse sensor with PWM control function

PWM duty cycle

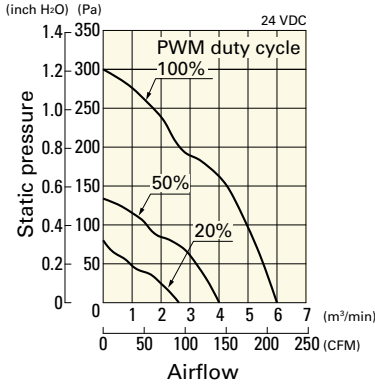

Operating voltage range

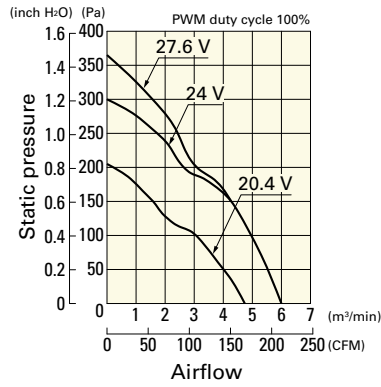

PWM duty - Speed characteristics example

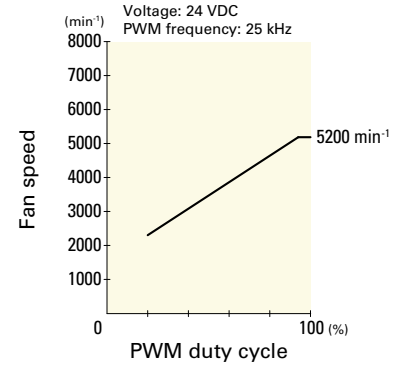

**9LG1424P1M001** With pulse sensor with PWM control function

PWM duty cycle

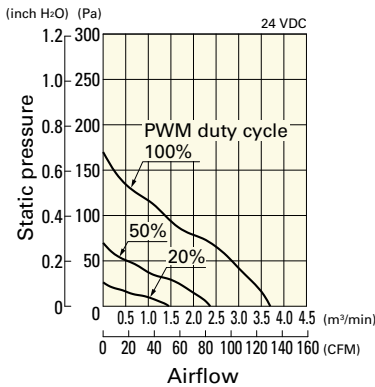

Operating voltage range

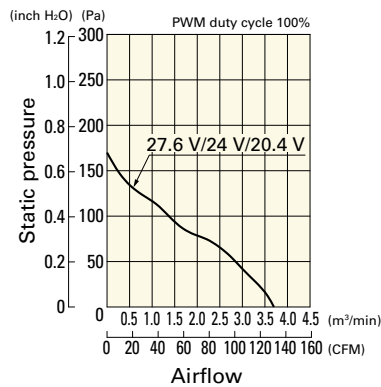

PWM duty - Speed characteristics example

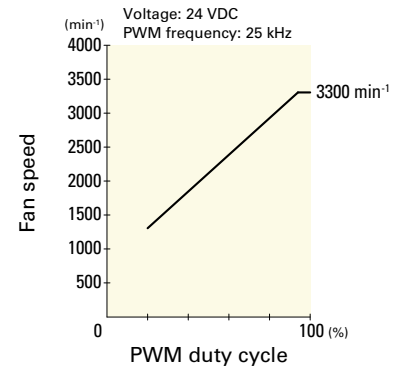

**9LG1448P1A001** With pulse sensor with PWM control function

PWM duty cycle

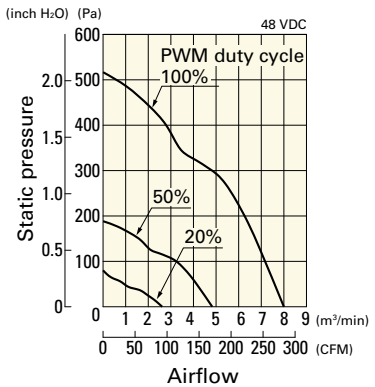

Operating voltage range

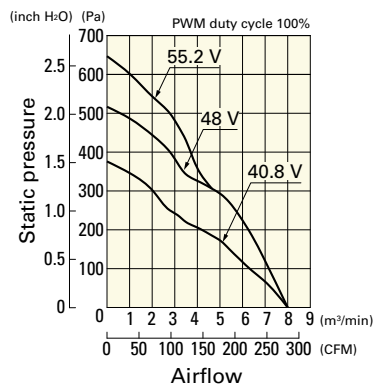

PWM duty - Speed characteristics example

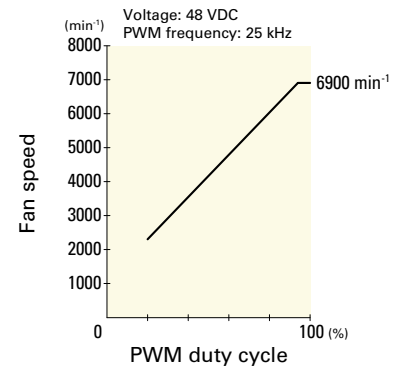

**9LG1448P1H001** With pulse sensor with PWM control function

PWM duty cycle

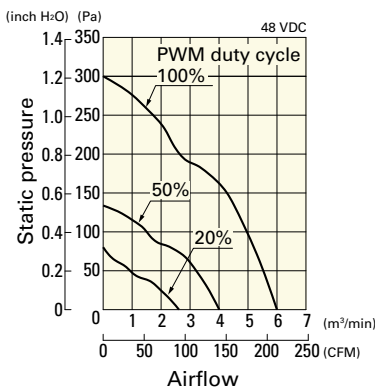

Operating voltage range

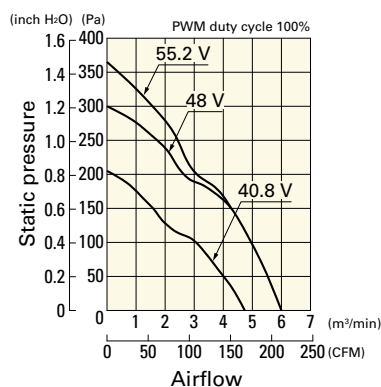

PWM duty - Speed characteristics example

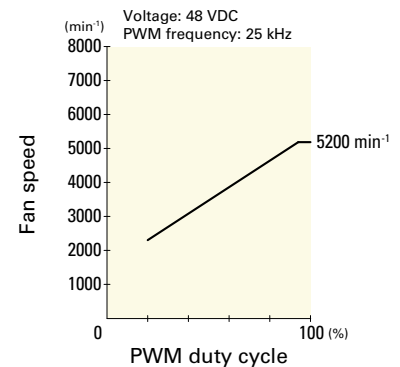

DC Long Life Fan 140 mm sq.

## Airflow - Static Pressure Characteristics / PWM Duty - Speed Characteristics Example

**9LG1448P1M001** With pulse sensor with PWM control function

PWM duty cycle

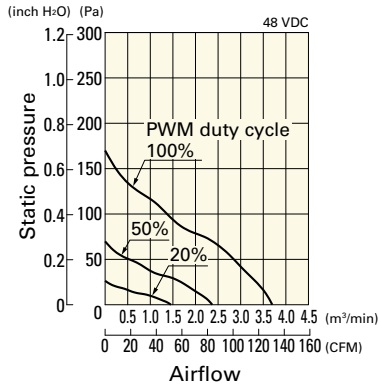

Operating voltage range

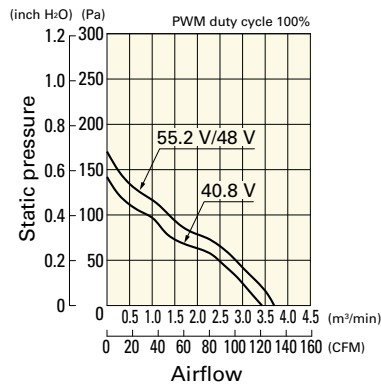

PWM duty - Speed characteristics example

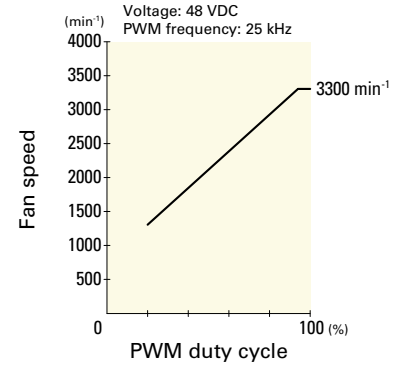

## Airflow - Static Pressure Characteristics

**9LG1412L1001** With pulse sensor

Operating voltage range

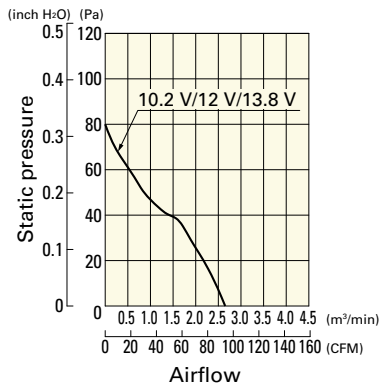

**9LG1424L1001** With pulse sensor

Operating voltage range

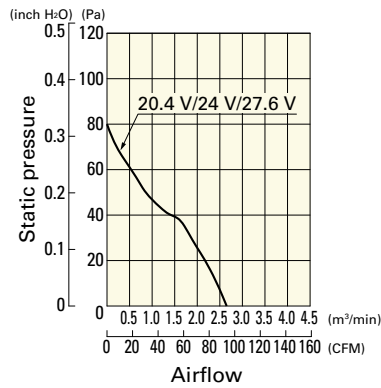

**9LG1448L1001** With pulse sensor

Operating voltage range

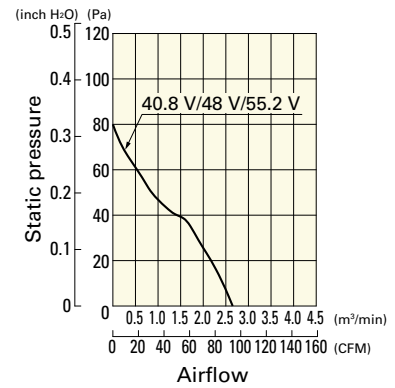

## Dimensions (unit: mm) (With pulse sensor with PWM control function)

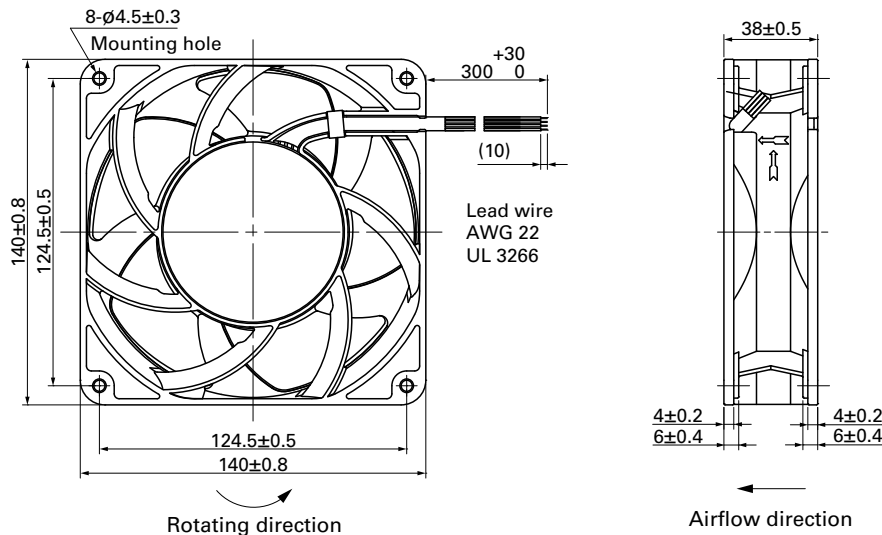

DC  
Long Life Fan 140 mm sq.

Reference Dimensions of Mounting Holes and Vent Opening (unit: mm)

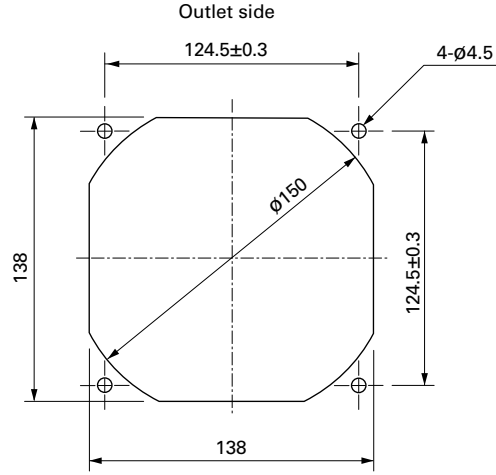
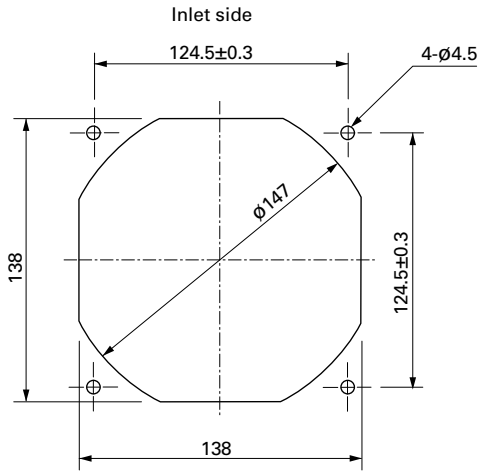

Options

Finger guards

page: p. 565

Model no.: 109-719, 109-719H

DC  
Long Life Fan 140 mm sq.